

Fișă tehnică | Număr articol: 727-126/003-000

8-level same potential terminal block; for 35 x 7.5 mounting rail; 1,50 mm²; orange

www.wago.com/727-126/003-000

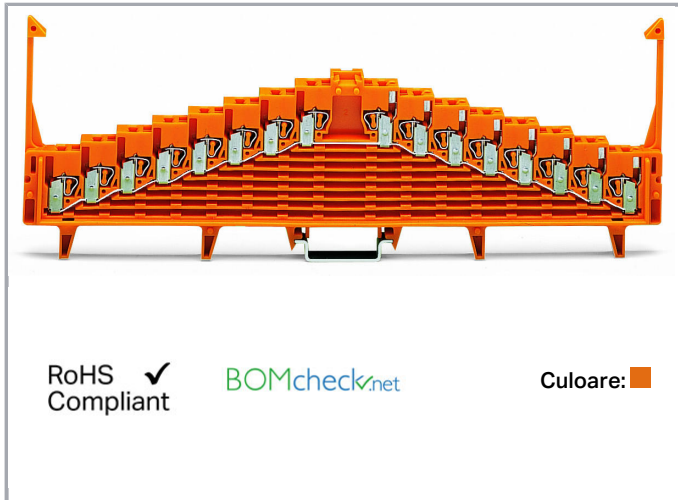

Date

Electrical data

Ratings per IEC/EN 60664-1

Nominal voltage (III/3)	250 V
Rated surge voltage (III/3)	4 kV
Rated current	18 A
Legend (ratings)	(III / 3) ≙ Overvoltage category III / Pollution degree 3

Connection data

Connection technology	CAGE CLAMP®
Actuation type	Operating tool
Connectable conductor materials	Copper
Solid conductor	0.08 ... 1.5 mm ² / 28 ... 16 AWG
Fine-stranded conductor	0.08 ... 1.5 mm ² / 28 ... 16 AWG
Strip length	8 ... 10 mm / 0.31 ... 0.39 inch
Total number of connection points	32
Total number of potentials	1
Number of levels	8
Wiring type	Front-entry wiring

Supus modificărilor.

WAGO Kontakttechnik GmbH & Co. KG
/Representative Office Romania
Sos. Pipera-Tunari nr. 1/1
building 1, 2nd floor | 077190 Voluntari, Ilfov
Tel.: +40-(0)31 421 85 68 | Email: info-RO@wago.com

Aveți întrebări despre produsele noastre?
Vă stăm la dispoziție pentru preluarea apelului la +40 (0) 31 421 85 68.

Geometrical Data

Width	7.62 mm / 0.3 inch
Height from upper-edge of DIN-rail	58.5 mm / 2.303 inch
Depth	226 mm / 8.898 inch

Mechanical data

Design	horizontal
Mounting type	DIN-35 rail
Marking	7-6-5-4-3-2-1-0--0-1-2-3-4-5-6-7
Marking level	Center marking

Material Data



Color	orange
Insulation material	Polyamide 66 (PA 66)
Fire load	1,169 MJ
Weight	61,1 g

Commercial data

Packaging type	BOX
Country of origin	DE
GTIN	4045454187521
Customs tariff number	85369010000

Aprobări / certificate

Country specific Approvals

Emblemă	Aprobare	Text de aprobare suplimentar	Nume certificat
	CCA DEKRA Certification B.V.	EN 60947	NTR NL 7485
	CSA DEKRA Certification B.V.	C22.2 No. 158	70048845
	KEMA/KEUR DEKRA Certification B.V.	EN 60947	2192101.01

Supus modificărilor.



Counterpart

Produse compatibile

tools



Nr. articol: 210-647

Operating tool; Blade: 2.5 x 0.4 mm; with a partially insulated shaft

www.wago.com/210-647



Nr. articol: 210-719

Operating tool; Blade: 2.5 x 0.4 mm; with a partially insulated shaft

www.wago.com/210-719

ferrule



Nr. articol: 216-101

Ferrule; Sleeve for 0.5 mm² / AWG 22; uninsulated; electro-tin plated

www.wago.com/216-101



Nr. articol: 216-102

Ferrule; Sleeve for 0.75 mm² / AWG 20; uninsulated; electro-tin plated

www.wago.com/216-102



Nr. articol: 216-103

Ferrule; Sleeve for 1 mm² / AWG 18; uninsulated; electro-tin plated

www.wago.com/216-103



Nr. articol: 216-104

Ferrule; Sleeve for 1.5 mm² / AWG 16; uninsulated; electro-tin plated

www.wago.com/216-104



Nr. articol: 216-121

Ferrule; Sleeve for 0.5 mm² / AWG 22; uninsulated; electro-tin plated

www.wago.com/216-121



Nr. articol: 216-122

Ferrule; Sleeve for 0.75 mm² / AWG 20; uninsulated; electro-tin plated

www.wago.com/216-122



Nr. articol: 216-123

Ferrule; Sleeve for 1 mm² / AWG 18; uninsulated; electro-tin plated

www.wago.com/216-123



















Nr. articol: 216-124

Ferrule; Sleeve for 1.5 mm² / AWG 16; uninsulated; electro-tin plated

www.wago.com/216-124

Supus modificărilor.

	Nr. articol: 216-131 Ferrule; Sleeve for 0.25 mm ² / AWG 24; uninsulated; electro-tin plated	www.wago.com/216-131
	Nr. articol: 216-132 Ferrule; Sleeve for 0.34 mm ² / AWG 24; uninsulated; electro-tin plated	www.wago.com/216-132
	Nr. articol: 216-151 Ferrule; Sleeve for 0.25 mm ² / AWG 24; uninsulated; electro-tin plated	www.wago.com/216-151
	Nr. articol: 216-152 Ferrule; Sleeve for 0.34 mm ² / AWG 24; uninsulated; electro-tin plated	www.wago.com/216-152
	Nr. articol: 216-201 Ferrule; Sleeve for 0.5 mm ² / 20 AWG; insulated; electro-tin plated; white	www.wago.com/216-201
	Nr. articol: 216-202 Ferrule; Sleeve for 0.75 mm ² / 18 AWG; insulated; electro-tin plated; gray	www.wago.com/216-202
	Nr. articol: 216-203 Ferrule; Sleeve for 1 mm ² / AWG 18; insulated; electro-tin plated; red	www.wago.com/216-203
	Nr. articol: 216-204 Ferrule; Sleeve for 1.5 mm ² / AWG 16; insulated; electro-tin plated; black	www.wago.com/216-204
	Nr. articol: 216-221 Ferrule; Sleeve for 0.5 mm ² / 20 AWG; insulated; electro-tin plated; white	www.wago.com/216-221
	Nr. articol: 216-222 Ferrule; Sleeve for 0.75 mm ² / 18 AWG; insulated; electro-tin plated; gray	www.wago.com/216-222
	Nr. articol: 216-223 Ferrule; Sleeve for 1 mm ² / AWG 18; insulated; electro-tin plated; red	www.wago.com/216-223
	Nr. articol: 216-224 Ferrule; Sleeve for 1.5 mm ² / AWG 16; insulated; electro-tin plated; black	www.wago.com/216-224
	Nr. articol: 216-301 Ferrule; Sleeve for 0.25 mm ² / AWG 24; insulated; electro-tin plated; yellow	www.wago.com/216-301
	Nr. articol: 216-302 Ferrule; Sleeve for 0.34 mm ² / 22 AWG; insulated; electro-tin plated; green	www.wago.com/216-302
	Nr. articol: 216-321 Ferrule; Sleeve for 0.25 mm ² / AWG 24; insulated; electro-tin plated; yellow	www.wago.com/216-321
	Nr. articol: 216-322 Ferrule; Sleeve for 0.34 mm ² / 22 AWG; insulated; electro-tin plated; green	www.wago.com/216-322
Insulation stop		
	Nr. articol: 727-197 Insulation stop; 0.08 - 0.2 mm ² "s" (0.14 mm ² "f-st"); 8 pieces/strip; white	www.wago.com/727-197
	Nr. articol: 727-198 Insulation stop; 0.25 mm ² "s"; 0.14 - 0.25 mm ² "f-st"; 8 pieces/strip; light gray	www.wago.com/727-198

Supus modificărilor.

WAGO Kontakttechnik GmbH & Co. KG
/Representative Office Romania
Sos. Pipera-Tunari nr. 1/1
building 1, 2nd floor | 077190 Voluntari, Ilfov
Tel.: +40-(0)31 421 85 68 | Email: info-RO@wago.com

Aveți întrebări despre produsele noastre?
Vă stăm la dispoziție pentru preluarea apelului la +40 (0) 31 421 85 68.



Nr. articol: 727-199
Insulation stop; 0.25 - 0.5 mm² "s+f-st"; 8 pieces/strip; dark gray

www.wago.com/727-199

Carrier rail



Nr. articol: 210-112
Steel carrier rail; 35 x 7.5 mm; 1 mm thick; 2 m long; slotted; according to EN 60715; "Hole width 25 mm

www.wago.com/210-112

Nr. articol: 210-113
Steel carrier rail; 35 x 7.5 mm; 1 mm thick; 2 m long; unslotted; according to EN 60715

www.wago.com/210-113

Nr. articol: 210-114
Steel carrier rail; 35 x 15 mm; 1.5 mm thick; 2 m long; unslotted; similar to EN 60715

www.wago.com/210-114

Nr. articol: 210-115
Steel carrier rail; 35 x 7.5 mm; 1 mm thick; 2 m long; slotted; according to EN 60715; "Hole width 18 mm

www.wago.com/210-115



Nr. articol: 210-118
Steel carrier rail; 35 x 15 mm; 2.3 mm thick; 2 m long; unslotted; according to EN 60715

www.wago.com/210-118



Nr. articol: 210-196
Aluminum carrier rail; 35 x 8.2 mm; 1.6 mm thick; 2 m long; unslotted; similar to EN 60715; silver-colored

www.wago.com/210-196



Nr. articol: 210-197
Steel carrier rail; 35 x 15 mm; 1.5 mm thick; 2 m long; slotted; similar to EN 60715

www.wago.com/210-197



Nr. articol: 210-198
Copper carrier rail; 35 x 15 mm; 2.3 mm thick; 2 m long; unslotted; according to EN 60715; copper-colored

www.wago.com/210-198



Nr. articol: 210-504
Steel carrier rail; 35 x 7.5 mm; 1 mm thick; 2 m long; slotted; galvanized; according to EN 60715

www.wago.com/210-504



Nr. articol: 210-505
Steel carrier rail; 35 x 7.5 mm; 1 mm thick; 2 m long; unslotted; galvanized; according to EN 60715

www.wago.com/210-505



Nr. articol: 210-506
Steel carrier rail; 35 x 15 mm; 1.5 mm thick; 2 m long; unslotted; galvanized; similar to EN 60715

www.wago.com/210-506



Nr. articol: 210-508
Steel carrier rail; 35 x 15 mm; 1.5 mm thick; 2 m long; slotted; galvanized; similar to EN 60715

www.wago.com/210-508

Marking accessories



Nr. articol: 2009-115
WMB-Inline; for Smart Printer; 1500 pieces on roll; stretchable 5 - 5.2 mm; plain; snap-on type; white

www.wago.com/2009-115



Nr. articol: 2009-115/000-002
WMB-Inline; for Smart Printer; 1500 pieces on roll; stretchable 5 - 5.2 mm; plain; snap-on type; yellow /000-002















www.wago.com/2009-115



Nr. articol: 2009-115/000-006
WMB-Inline; for Smart Printer; 1500 pieces on roll; stretchable 5 - 5.2 mm; plain; snap-on type; blue /000-006

www.wago.com/2009-115

Supus modificărilor.

	Nr. articol: 2009-115/000-007 WMB-Inline; for Smart Printer; 1500 pieces on roll; stretchable 5 - 5.2 mm; plain; snap-on type; gray	www.wago.com/2009-115/000-007
	Nr. articol: 2009-115/000-012 WMB-Inline; for Smart Printer; 1500 pieces on roll; stretchable 5 - 5.2 mm; plain; snap-on type; orange	www.wago.com/2009-115/000-012
	Nr. articol: 2009-115/000-017 WMB-Inline; for Smart Printer; 1500 pieces on roll; stretchable 5 - 5.2 mm; plain; snap-on type; light green	www.wago.com/2009-115/000-017
	Nr. articol: 2009-115/000-023 WMB-Inline; for Smart Printer; 1500 pieces on roll; stretchable 5 - 5.2 mm; plain; snap-on type; green	www.wago.com/2009-115/000-023
	Nr. articol: 2009-115/000-024 WMB-Inline; for Smart Printer; 1500 pieces on roll; stretchable 5 - 5.2 mm; plain; snap-on type; violet	www.wago.com/2009-115/000-024
	Nr. articol: 209-128 Adaptor; gray	www.wago.com/209-128
	Nr. articol: 793-501 WMB marking card; as card; not stretchable; plain; snap-on type; white	www.wago.com/793-501
	Nr. articol: 793-501/000-002 WMB marking card; as card; not stretchable; plain; snap-on type; yellow	www.wago.com/793-501/000-002
	Nr. articol: 793-501/000-005 WMB marking card; as card; not stretchable; plain; snap-on type; red	www.wago.com/793-501/000-005
	Nr. articol: 793-501/000-006 WMB marking card; as card; not stretchable; plain; snap-on type; blue	www.wago.com/793-501/000-006
	Nr. articol: 793-501/000-007 WMB marking card; as card; not stretchable; plain; snap-on type; gray	www.wago.com/793-501/000-007
	Nr. articol: 793-501/000-012 WMB marking card; as card; not stretchable; plain; snap-on type; orange	www.wago.com/793-501/000-012
	Nr. articol: 793-501/000-017 WMB marking card; as card; not stretchable; plain; snap-on type; light green	www.wago.com/793-501/000-017
	Nr. articol: 793-501/000-023 WMB marking card; as card; not stretchable; plain; snap-on type; green	www.wago.com/793-501/000-023

Supus modificărilor.



Nr. articol: 793-501/000-024
WMB marking card; as card; not stretchable; plain; snap-on type; violet

www.wago.com/793-501/000-024



Nr. articol: 793-5501
WMB marking card; as card; for terminal block width 5 - 17.5 mm; stretchable 5 - 5.2 mm; plain; snap-on type; white

www.wago.com/793-5501



Nr. articol: 793-5501/000-002
WMB marking card; as card; for terminal block width 5 - 17.5 mm; stretchable 5 - 5.2 mm; plain; snap-on type; yellow

www.wago.com/793-5501/000-002



Nr. articol: 793-5501/000-005
WMB marking card; as card; for terminal block width 5 - 17.5 mm; stretchable 5 - 5.2 mm; plain; snap-on type; red

www.wago.com/793-5501/000-005



Nr. articol: 793-5501/000-006
WMB marking card; as card; for terminal block width 5 - 17.5 mm; stretchable 5 - 5.2 mm; plain; snap-on type; blue

www.wago.com/793-5501/000-006



Nr. articol: 793-5501/000-007
WMB marking card; as card; for terminal block width 5 - 17.5 mm; stretchable 5 - 5.2 mm; plain; snap-on type; gray

www.wago.com/793-5501/000-007



Nr. articol: 793-5501/000-012
WMB marking card; as card; for terminal block width 5 - 17.5 mm; stretchable 5 - 5.2 mm; plain; snap-on type; orange

www.wago.com/793-5501/000-012



Nr. articol: 793-5501/000-017
WMB marking card; as card; for terminal block width 5 - 17.5 mm; stretchable 5 - 5.2 mm; plain; snap-on type; green

www.wago.com/793-5501/000-017



Nr. articol: 793-5501/000-023
WMB marking card; as card; for terminal block width 5 - 17.5 mm; stretchable 5 - 5.2 mm; plain; snap-on type; light green

www.wago.com/793-5501/000-023



Nr. articol: 793-5501/000-024
WMB marking card; as card; for terminal block width 5 - 17.5 mm; stretchable 5 - 5.2 mm; plain; snap-on type; violet

www.wago.com/793-5501/000-024



Nr. articol: 793-933
WMB marking card; as card; MARKED; E0.0, E0.1, ..., E9.6, E9.7 (1 each); not stretchable; Vertical marking; snap-on type; white

www.wago.com/793-933

End plate



Nr. articol: 727-105
8-level end plate; marking: 0-1-2-3-4-5-6-7--7-6-5-4-3-2-1; 7.62 mm thick; orange

www.wago.com/727-105



Nr. articol: 727-106
8-level end plate; marking: a-b-c-d-e-f-g-h--h-g-f-e-d-c-b-a; 7.62 mm thick; orange



















www.wago.com/727-106





Nr. articol: 727-107
8-level end plate; marking: 7-6-5-4-3-2-1-0--0-1-2-3-4-5-6-7; 7.62 mm thick; orange



www.wago.com/727-107

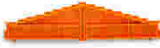

Supus modificărilor.

	Nr. articol: 727-108 8-level end plate; marking: h-g-f-e-d-c-b-a--a-b-c-d-e-f-g-h; 7.62 mm thick; orange	www.wago.com/727-108
	Nr. articol: 727-113 8-level end plate; plain; 7.62 mm thick; gray	www.wago.com/727-113
	Nr. articol: 727-114 8-level end plate; plain; 7.62 mm thick; blue	www.wago.com/727-114
	Nr. articol: 727-115 8-level end plate; plain; 7.62 mm thick; white	www.wago.com/727-115
	Nr. articol: 727-116 8-level end plate; plain; 7.62 mm thick; light gray	www.wago.com/727-116
	Nr. articol: 727-117 8-level end plate; plain; 7.62 mm thick; orange	www.wago.com/727-117
	Nr. articol: 727-155 8-level end plate; marking: 0-1-2-3-4-5-6-7--7-6-5-4-3-2-1; 7.62 mm thick; gray	www.wago.com/727-155
	Nr. articol: 727-156 8-level end plate; marking: a-b-c-d-e-f-g-h--h-g-f-e-d-c-b-a; 7.62 mm thick; gray	www.wago.com/727-156
	Nr. articol: 727-157 8-level end plate; marking: 7-6-5-4-3-2-1-0--0-1-2-3-4-5-6-7; 7.62 mm thick; gray	www.wago.com/727-157
	Nr. articol: 727-158 8-level end plate; marking: h-g-f-e-d-c-b-a--a-b-c-d-e-f-g-h; 7.62 mm thick; gray	www.wago.com/727-158
	Nr. articol: 727-159 8-level end plate; marking: 0-1-2-3-4-5-6-7--7-6-5-4-3-2-1; 7.62 mm thick; blue	www.wago.com/727-159
	Nr. articol: 727-160 8-level end plate; marking: a-b-c-d-e-f-g-h--h-g-f-e-d-c-b-a; 7.62 mm thick; blue	www.wago.com/727-160
	Nr. articol: 727-161 8-level end plate; marking: 7-6-5-4-3-2-1-0--0-1-2-3-4-5-6-7; 7.62 mm thick; blue	www.wago.com/727-161
	Nr. articol: 727-162 8-level end plate; marking: h-g-f-e-d-c-b-a--a-b-c-d-e-f-g-h; 7.62 mm thick; blue	www.wago.com/727-162
	Nr. articol: 727-163 8-level end plate; marking: 0-1-2-3-4-5-6-7--7-6-5-4-3-2-1; 7.62 mm thick; white	www.wago.com/727-163
	Nr. articol: 727-164 8-level end plate; marking: a-b-c-d-e-f-g-h--h-g-f-e-d-c-b-a; 7.62 mm thick; white	www.wago.com/727-164
	Nr. articol: 727-165 8-level end plate; marking: 7-6-5-4-3-2-1-0--0-1-2-3-4-5-6-7; 7.62 mm thick; white	www.wago.com/727-165
	Nr. articol: 727-166 8-level end plate; marking: h-g-f-e-d-c-b-a--a-b-c-d-e-f-g-h; 7.62 mm thick; white	www.wago.com/727-166

Supus modificărilor.

	Nr. articol: 727-167 8-level end plate; marking: 0-1-2-3-4-5-6-7--7-6-5-4-3-2-1; 7.62 mm thick; light gray	www.wago.com/727-167
	Nr. articol: 727-168 8-level end plate; marking: a-b-c-d-e-f-g-h--h-g-f-e-d-c-b-a; 7.62 mm thick; light gray	www.wago.com/727-168
	Nr. articol: 727-169 8-level end plate; marking: 7-6-5-4-3-2-1-0--0-1-2-3-4-5-6-7; 7.62 mm thick; light gray	www.wago.com/727-169
	Nr. articol: 727-170 8-level end plate; marking: h-g-f-e-d-c-b-a--a-b-c-d-e-f-g-h; 7.62 mm thick; light gray	www.wago.com/727-170

check		
	Nr. articol: 210-137 Test plug; 2.3 mm Ø; with 500 mm cable; yellow	www.wago.com/210-137
	Nr. articol: 210-297 Step-down test plug; from 4mm socket to 2mm plug; red	www.wago.com/210-297

General accessories		
	Nr. articol: 249-109 Wire harness support; gray	www.wago.com/249-109
Jumper		
	Nr. articol: 709-107 Wire commoning chain; insulated; 32 connections; gray	www.wago.com/709-107

Descărcări

Documentation

Additional Information

Technical explanations	Apr 3, 2019	pdf 2,1 MB	Descărcare
------------------------	-------------	---------------	------------

CAD/CAE-Data

CAD data

2D/3D Models 727-126/003-000	URL	Descărcare
------------------------------	-----	------------

CAE data

EPLAN Data Portal 727-126/003-000	URL	Descărcare
-----------------------------------	-----	------------

WSCAD Universe 727-126/003-000	URL	Descărcare
--------------------------------	-----	------------

Supus modificărilor.

WAGO Kontakttechnik GmbH & Co. KG
/Representative Office Romania
Sos. Pipera-Tunari nr. 1/1
building 1, 2nd floor | 077190 Voluntari, Ilfov
Tel.: +40-(0)31 421 85 68 | Email: info-RO@wago.com

Aveți întrebări despre produsele noastre?
Vă stăm la dispoziție pentru preluarea apelului la +40 (0) 31 421 85 68.

Installation Notes

Assembly

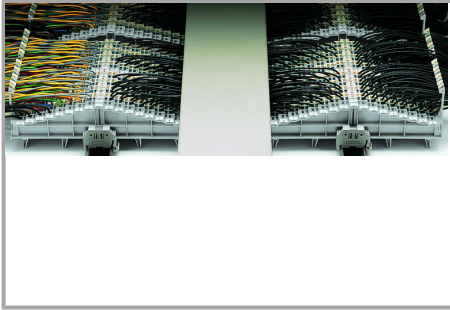

Example:

Left: Main cables fed through locking clips on the field side

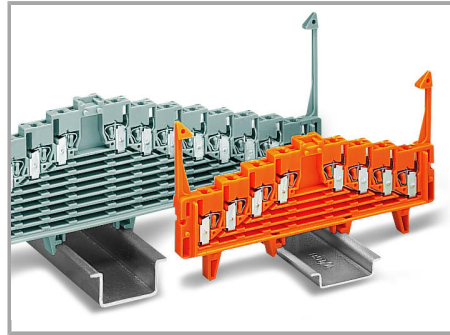

Terminal blocks for DIN 35 x 7.5 mm or DIN 35 x 15 mm rails are available.

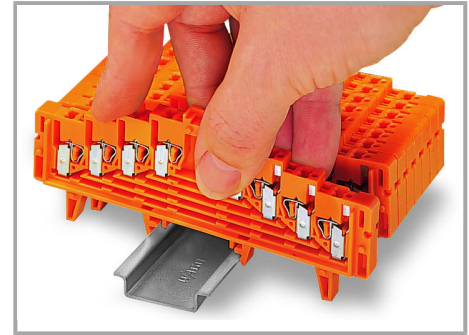

Snap individual 4- or 8-level terminal blocks onto the carrier rail.

Right: Control cables fed between locking clips

Center: Wiring of both patching sides

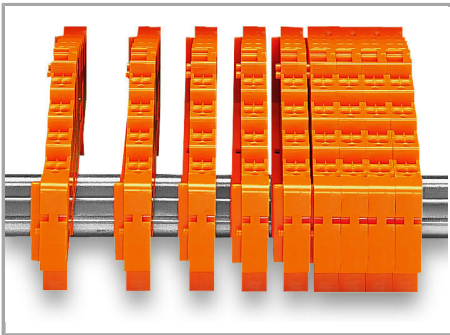

Slide terminal blocks together.

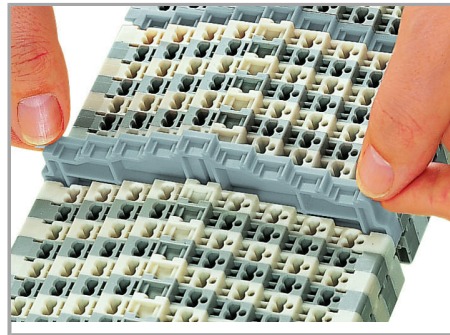

Grip end plate at both sides and:

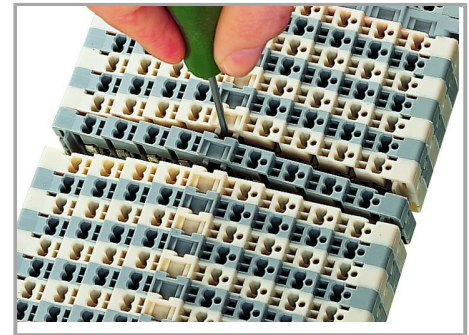

Open the assembly by laterally sliding a block via operating tool (2.5 x 0.4 mm blade).

- push down (assembly)
-
- pull up (removal)
-

Supus modificărilor.

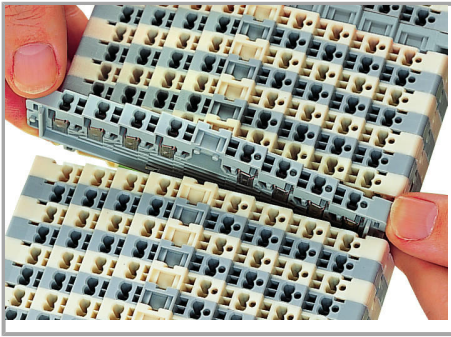

Slide terminal block and remove from the rail with a levering action.

Inserting a conductor

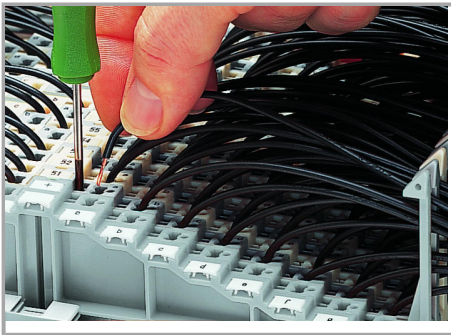

CAGE CLAMP® connection

Inserting a conductor via 210-719 Operating Tool (2.5 x 0.4 mm blade).

Max. cross section for uninsulated ferrules
1 mm² / 18 AWG, for insulated ferrules
0.75 mm² / 20 AWG.

Testing

Supus modificărilor.

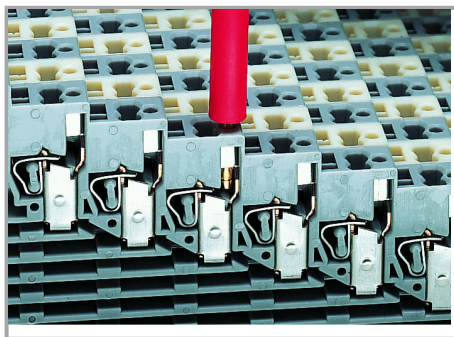

Special test contact for 2.3 mm Ø test plug.

Ex Application

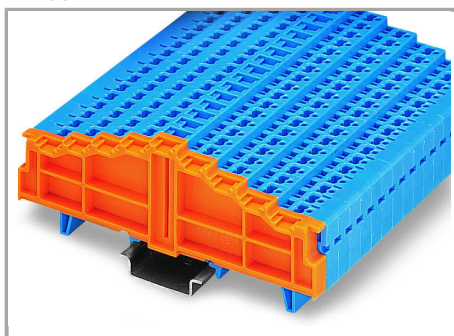

Blue terminal blocks for matrix patching are suitable for Ex i applications.

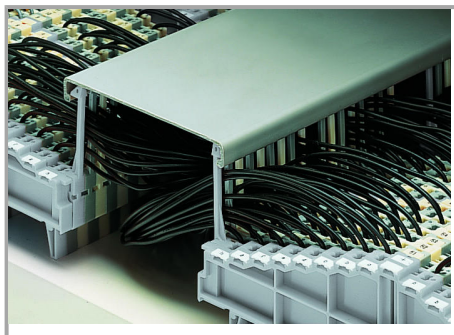

Using terminal blocks with locking clips, the wiring space between the terminal strips can be covered with a wiring duct cover.

Marking

Supus modificărilor.

WAGO Kontakttechnik GmbH & Co. KG
/Representative Office Romania
Sos. Pipera-Tunari nr. 1/1
building 1, 2nd floor | 077190 Voluntari, Ilfov
Tel.: +40-(0)31 421 85 68 | Email: info-RO@wago.com

Aveți întrebări despre produsele noastre?
Vă stăm la dispoziție pentru preluarea apelului la +40 (0) 31 421 85 68.



Connection points identified via factory-direct printing



Marking coordinates via WMB Multi Marking System.

Supus modificărilor.