

## Fișă tehnică | Număr articol: 722-833/039-000

THT female header; 0.6 x 1.0 mm solder pin; angled; 100% protected against mismatching; Locking lever; Pin spacing 7.5 mm; 3-pole; light gray



[www.wago.com/722-833/039-000](http://www.wago.com/722-833/039-000)



Supus modificărilor.

WAGO Kontakttechnik GmbH & Co. KG  
/Representative Office Romania  
Sos. Pipera-Tunari nr. 1/1  
building 1, 2nd floor | 077190 Voluntari, Ilfov  
Tel.: +40-(0)31 421 85 68 | Email: info-RO@wago.com

Aveți întrebări despre produsele noastre?  
Vă stăm la dispoziție pentru preluarea apelului la +40 (0) 31 421 85 68.

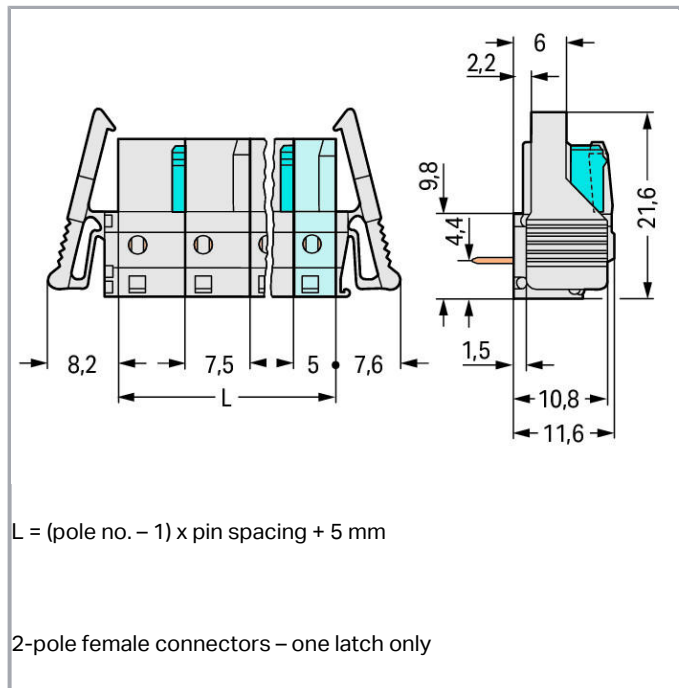

## Descriere articol

- Horizontal or vertical PCB mounting via straight or angled solder pins
- For board-to-board and board-to-wire connections
- Touch-proof PCB outputs
- Easy-to-identify PCB inputs and outputs
- 100 % protected against mismatching
- With coding fingers

### Safety information 1:

The *MULTI CONNECTION SYSTEM (MCS)* is designed without breaking capacity for compliance with DIN EN 61984. When used as intended, MCS Connectors shall not be connected/disconnected when live or under load. The circuit design should ensure header pins, which can be touched, are not live when unmated.

## Date

### Electrical data

### Ratings per IEC/EN 60664-1

Ratings per	IEC/EN 60664-1
Nominal voltage (III/3)	500 V
Rated surge voltage (III/3)	6 kV

Supus modificărilor.

WAGO Kontakttechnik GmbH & Co. KG  
 /Representative Office Romania  
 Sos. Pipera-Tunari nr. 1/1  
 building 1, 2nd floor | 077190 Voluntari, Ilfov  
 Tel.: +40-(0)31 421 85 68 | Email: info-RO@wago.com

Aveți întrebări despre produsele noastre?  
 Vă stăm la dispoziție pentru preluarea apelului la +40 (0) 31 421 85 68.



Rated voltage (III/2)	630 V
Rated surge voltage (III/2)	6 kV
Nominal voltage (II/2)	1000 V
Rated surge voltage (II/2)	6 kV
Rated current	12 A
Legend (ratings)	(III / 2) $\triangleq$ Overvoltage category III / Pollution degree 2

### Approvals per UL 1059

Rated voltage UL (Use Group B)	300 V
Rated current UL (Use Group B)	15 A
Rated voltage UL (Use Group D)	300 V
Rated current UL (Use Group D)	10 A
Approvals per	UL 1059

### Approvals per UL 1977

Rated voltage UL 1977	600 V
Rated current UL 1977	15 A

### Approvals per CSA

Rated voltage CSA (Use Group B)	300 V
Rated current CSA (Use Group B)	15 A
Rated voltage CSA (Use Group D)	300 V
Rated current CSA (Use Group D)	10 A

### Connection data

Pole No.	3
Total number of potentials	3
Number of connection types	1
Number of levels	1

### Geometrical Data

Pin spacing	7.5 mm / 0.295 inch
Width	35.8 mm / 1.409 inch
Height	16.6 mm / 0.654 inch
Height from the surface	11.6 mm / 0.457 inch
Depth	18.25 mm / 0.719 inch

Supus modificărilor.

WAGO Kontakttechnik GmbH & Co. KG  
 /Representative Office Romania  
 Sos. Pipera-Tunari nr. 1/1  
 building 1, 2nd floor | 077190 Voluntari, Ilfov  
 Tel.: +40-(0)31 421 85 68 | Email: info-RO@wago.com

Aveți întrebări despre produsele noastre?  
 Vă stăm la dispoziție pentru preluarea apelului la +40 (0) 31 421 85 68.



Solder pin length	5 mm
Solder pin dimensions	0.6 x 1 mm
Drilled hole diameter with tolerance	1.3 <sup>(+0.1)</sup> mm

**Plug connection**

Contact type (pluggable connector)	Female connector/socket
Connector (connection type)	for PCBs
Mismating protection	Yes
Mating direction to the PCB	0°
Locking of plug-in connection	locking lever

**PCB contact**

PCB contact	THT
Solder pin arrangement	over the entire female connector, in line
Number of solder pins per potential	1

**Material Data**

Color	light gray
Material group	I
Insulation material	Polyamide 66 (PA 66)
Flammability class per UL94	V0
Contact material	Copper alloy
Contact plating	tin-plated
Fire load	0,086 MJ
Weight	4,1 g

**Environmental Requirements**

Limit temperature range	-60 ... +85 °C
-------------------------	----------------

**Commercial data**

Product Group	3 (Multi Conn. System)
Packaging type	BOX
Country of origin	DE
GTIN	4045454742072
Customs tariff number	85366990990

Supus modificărilor.

WAGO Kontakttechnik GmbH & Co. KG  
 /Representative Office Romania  
 Sos. Pipera-Tunari nr. 1/1  
 building 1, 2nd floor | 077190 Voluntari, Ilfov  
 Tel.: +40-(0)31 421 85 68 | Email: info-RO@wago.com



Aveți întrebări despre produsele noastre?  
 Vă stăm la dispoziție pentru preluarea apelului la +40 (0) 31 421 85 68.

## Aprobări / certificate

## Ship Approvals

Emblemă	Aprobare	Text de aprobare suplimentar	Nume certificat
	<b>ABS</b> American Bureau of Shipping	-	19- HG1869876- PDA

## UL-Approvals

Emblemă	Aprobare	Text de aprobare suplimentar	Nume certificat
	<b>UR</b> Underwriters Laboratories Inc.	UL 1059	E45172
	<b>UR</b> Underwriters Laboratories Inc.	UL 1977	20150318- E45171

## Counterpart





Nr. articol 723-603

1-conductor male connector; 100% protected against mismatching; 2.5 mm<sup>2</sup>; Pin spacing 7.5 mm; 3-pole; 2,50 mm<sup>2</sup>; light gray[www.wago.com/723-603](http://www.wago.com/723-603)

## Produse compatibile

## check

	<b>Nr. articol: 210-136</b> Test plug; 2 mm Ø; with 500 mm cable; red	<a href="http://www.wago.com/210-136">www.wago.com/210-136</a>
	<b>Nr. articol: 210-137</b> Test plug; 2.3 mm Ø; with 500 mm cable; yellow	<a href="http://www.wago.com/210-137">www.wago.com/210-137</a>
	<b>Nr. articol: 231-662</b> Test plugs for female connectors; for 7.5 mm and 7.62 mm pin spacing; 2,50 mm <sup>2</sup> ; light gray	<a href="http://www.wago.com/231-662">www.wago.com/231-662</a>

## Marking accessories

	<b>Nr. articol: 210-833</b> Marking strips; on reel; 6 mm wide; plain; Self-adhesive; white	<a href="http://www.wago.com/210-833">www.wago.com/210-833</a>
--	--	--

Supus modificărilor.

WAGO Kontakttechnik GmbH & Co. KG  
/Representative Office Romania  
Sos. Pipera-Tunari nr. 1/1  
building 1, 2nd floor | 077190 Voluntari, Ilfov  
Tel.: +40-(0)31 421 85 68 | Email: info-RO@wago.com

Aveți întrebări despre produsele noastre?  
Vă stăm la dispoziție pentru preluarea apelului la +40 (0) 31 421 85 68.



Nr. articol: 210-834

Marking strips; on reel; 5 mm wide; plain; Self-adhesive; white

[www.wago.com/210-834](http://www.wago.com/210-834)**Descărcări****Documentation****Additional Information**

Technical explanations

Apr 3, 2019

pdf  
3,6 MB

Descărcare

**CAD/CAE-Data****CAD data**

2D/3D Models 722-833/039-000

URL

Descărcare

**PCB Design**

Symbol and Footprint 722-833/039-000

URL

Descărcare

CAX data for your PCB design, consisting of "schematic symbols and PCB footprints", allow easy integration of the WAGO component into your development environment.

**Supported formats:**

- Accel EDA 14 & 15
- Altium 6 to current version
- Cadence Allegro
- DesignSpark
- Eagle Libraries
- KiCad
- Mentor Graphics BoardStation
- Mentor Graphics Design Architect
- Mentor Graphics Design Expedition 99 and 2000
- OrCAD 9.X PCB and Capture
- PADS PowerPCB 3, 3.5, 4.X, and 5.X
- PADS PowerPCB and PowerLogic 3.0
- PCAD 2000, 2001, 2002, 2004, and 2006
- Pulsonix 8.5 or newer
- STL
- 3D STEP
- TARGET 3001!

Supus modificărilor.

WAGO Kontakttechnik GmbH &amp; Co. KG

/Representative Office Romania

Sos. Pipera-Tunari nr. 1/1

building 1, 2nd floor | 077190 Voluntari, Ilfov

Tel.: +40-(0)31 421 85 68 | Email: info-RO@wago.com

Aveți întrebări despre produsele noastre?

Vă stăm la dispoziție pentru preluarea apelului la +40 (0) 31 421 85 68.



- View Logic ViewDraw
- Quadcept
- Zuken CadStar 3 and 4
- Zuken CR-5000 and CR-8000

PCB Component Libraries (EDA), PCB CAD Library Ultra Librarian

---

## Installation Notes

## Familie de produse

<i>MCS</i> MIDI

Afișare globală produse din familie.

Supus modificărilor.

---

WAGO Kontakttechnik GmbH & Co. KG  
/Representative Office Romania  
Sos. Pipera-Tunari nr. 1/1  
building 1, 2nd floor | 077190 Voluntari, Ilfov  
Tel.: +40-(0)31 421 85 68 | Email: info-RO@wago.com

Aveți întrebări despre produsele noastre?  
Vă stăm la dispoziție pentru preluarea apelului la +40 (0) 31 421 85 68.