

Fișă tehnică | Număr articol: 713-1414/117-000/997-408

THR male header, 2-row; 0.8 x 0.8 mm solder pin; straight; 100% protected against mismatching; in tape-and-reel packaging; Pin spacing 3.5 mm; 2 x 14-pole; black



www.wago.com/713-1414/117-000/997-408



RoHS Compliant

[BOMcheck.net](https://www.bomcheck.net)

Culoare:



Supus modificărilor.

WAGO Kontakttechnik GmbH & Co. KG
/Representative Office Romania
Sos. Pipera-Tunari nr. 1/1
building 1, 2nd floor | 077190 Voluntari, Ilfov
Tel.: +40-(0)31 421 85 68 | Email: info-RO@wago.com

Aveți întrebări despre produsele noastre?
Vă stăm la dispoziție pentru preluarea apelului la +40 (0) 31 421 85 68.

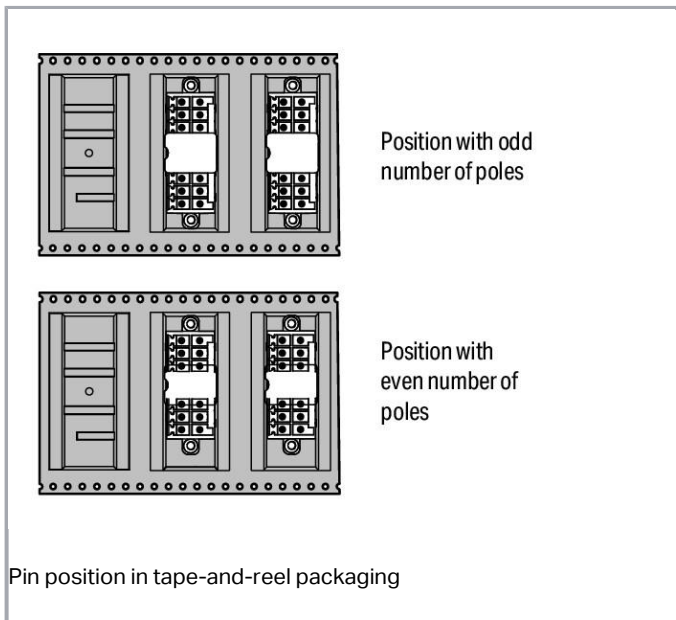
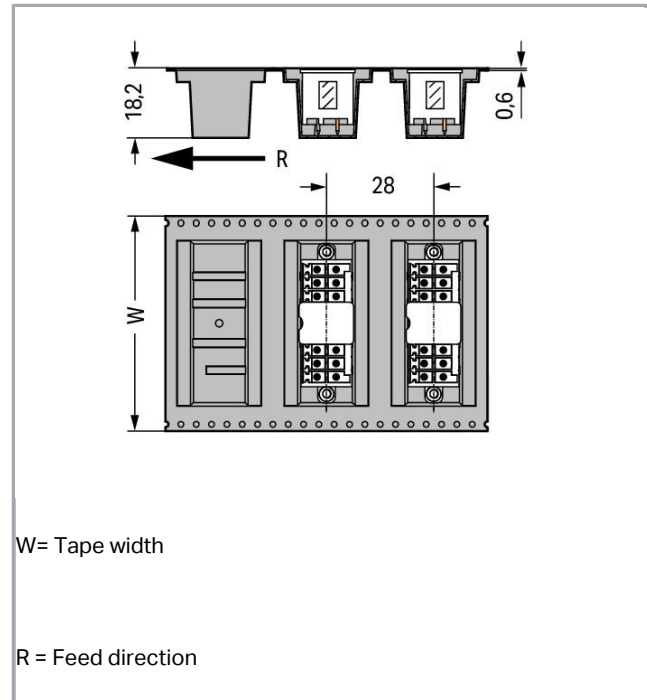
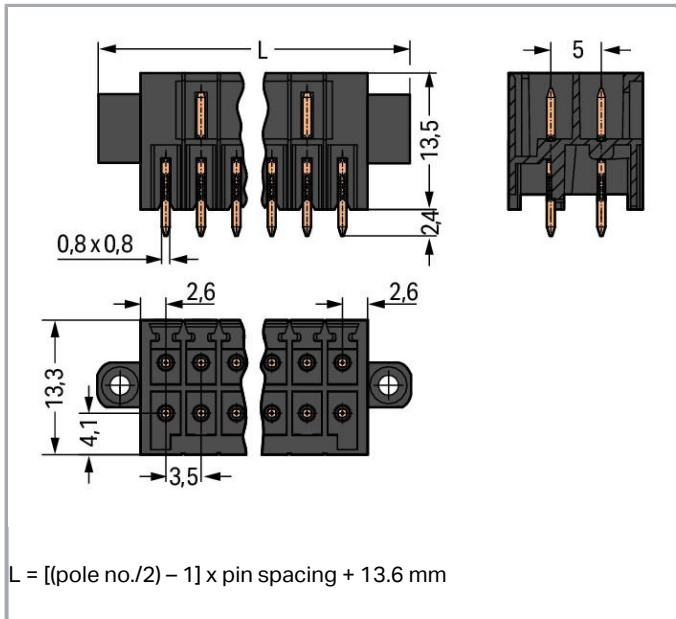

Descriere articol

- THR male headers for reflow soldering in SMT applications
- Available in tape-and-reel packaging for automated pick-and-place PCB assembly
- Separated pin slots prevent damage and make the headers touch-proof when unplugged
- 100% protected against mismatching

Supus modificărilor.

WAGO Kontakttechnik GmbH & Co. KG
 /Representative Office Romania
 Sos. Pipera-Tunari nr. 1/1
 building 1, 2nd floor | 077190 Voluntari, Ilfov
 Tel.: +40-(0)31 421 85 68 | Email: info-RO@wago.com

Aveți întrebări despre produsele noastre?
 Vă stăm la dispoziție pentru preluarea apelului la +40 (0) 31 421 85 68.



- Coding pins available

Safety information 1:

The *MULTI CONNECTION SYSTEM (MCS)* is designed without breaking capacity for compliance with DIN EN 61984. When used as intended, MCS Connectors shall not be connected/disconnected when live or under load. The circuit design should ensure header pins, which can be touched, are not live when unmated.

Date**Electrical data****Ratings per IEC/EN 60664-1**

Ratings per	IEC/EN 60664-1
Nominal voltage (III/3)	80 V
Rated surge voltage (III/3)	2,5 kV
Rated voltage (III/2)	160 V
Rated surge voltage (III/2)	2,5 kV
Nominal voltage (II/2)	250 V
Rated surge voltage (II/2)	2,5 kV
Rated current	10 A
Legend (ratings)	(III / 2) $\hat{=}$ Overvoltage category III / Pollution degree 2

Approvals per UL 1059

Rated voltage UL (Use Group B)	150 V
Rated current UL (Use Group B)	10 A
Rated voltage UL (Use Group C)	50 V
Rated current UL (Use Group C)	10 A
Approvals per	UL 1059

Approvals per CSA

Rated voltage CSA (Use Group B)	150 V
Rated current CSA (Use Group B)	12 A

Connection data

Pole No.	28
Total number of potentials	3
Number of connection types	1
Number of levels	2

Supus modificărilor.

WAGO Kontakttechnik GmbH & Co. KG
 /Representative Office Romania
 Sos. Pipera-Tunari nr. 1/1
 building 1, 2nd floor | 077190 Voluntari, Ilfov
 Tel.: +40-(0)31 421 85 68 | Email: info-RO@wago.com

Aveți întrebări despre produsele noastre?
 Vă stăm la dispoziție pentru preluarea apelului la +40 (0) 31 421 85 68.



Geometrical Data

Pin spacing	3.5 mm / 0.138 inch
Width	59.1 mm / 2.327 inch
Height	15.9 mm / 0.626 inch
Height from the surface	13.5 mm / 0.531 inch
Depth	13.3 mm / 0.524 inch
Solder pin length	2,4 mm
Solder pin dimensions	0.8 x 0.8 mm
Plated through-hole diameter (THR)	1.3 ^(+0.1) mm
Reel diameter of tape-and-reel packaging	330 mm
Tape width	72 mm

Plug connection

Contact type (pluggable connector)	Male connector/plug
Connector (connection type)	for PCBs
Mismating protection	Yes
Mating direction to the PCB	90°
Locking of plug-in connection	Threaded flange

PCB contact

PCB contact	THR
Solder pin arrangement	over the entire male connector, in line
Number of solder pins per potential	1

Material Data

Color	black
Material group	I
Insulation material	Polyphthalamide (PPA GF)
Flammability class per UL94	V0
Contact material	Electrolytic copper (E _{Cu})
Contact plating	tin-plated
Weight	7,6 g

Supus modificărilor.

WAGO Kontakttechnik GmbH & Co. KG
 /Representative Office Romania
 Sos. Pipera-Tunari nr. 1/1
 building 1, 2nd floor | 077190 Voluntari, Ilfov
 Tel.: +40-(0)31 421 85 68 | Email: info-RO@wago.com

Aveți întrebări despre produsele noastre?
 Vă stăm la dispoziție pentru preluarea apelului la +40 (0) 31 421 85 68.

Environmental Requirements

Limit temperature range	-60 ... +100 °C
-------------------------	-----------------

Commercial data

Packaging type	bag
Country of origin	DE
GTIN	4050821308928
Customs tariff number	85366990990

Aprobări / certificate

UL-Approvals

Emblemă	Aprobare	Text de aprobare suplimentar	Nume certificat
	UR Underwriters Laboratories Inc.	UL 1059	20190122- E45172

Counterpart



Nr. articol 713-1114/107-000

1-conductor female connector, 2-row; 100% protected against mismatching; Screw flange; 1.5 mm²; Pin spacing 3.5 mm; 28-pole; 1,50 mm²; black

www.wago.com/713-1114/107-000

Produse compatibile

Coding



Nr. articol: 714-101
Coding key; orange

www.wago.com/714-101

Descărcări

Documentation

Additional Information

Technical explanations	Apr 3, 2019	pdf 3,6 MB	Descărcare
------------------------	-------------	---------------	------------

Supus modificărilor.

Installation Notes

Coding

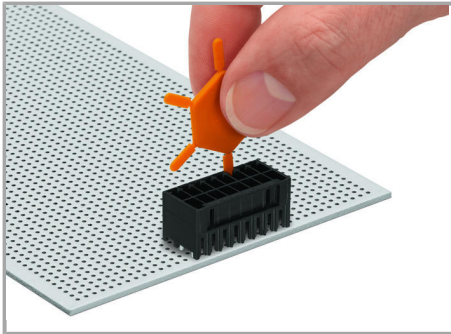

Coding a male header by inserting a coding pin.

Familie de produse

MCS MINI HD

Afișare globală produse din familie.

Supus modificărilor.