

Fișă tehnică | Număr articol: 279-517

Double-deck terminal block; Ground conductor/through terminal block; PE /N; without marker carrier; for DIN-rail 35 x 15 and 35 x 7.5; 1.5 mm²; CAGE CLAMP®; 1,50 mm²; gray

www.wago.com/279-517

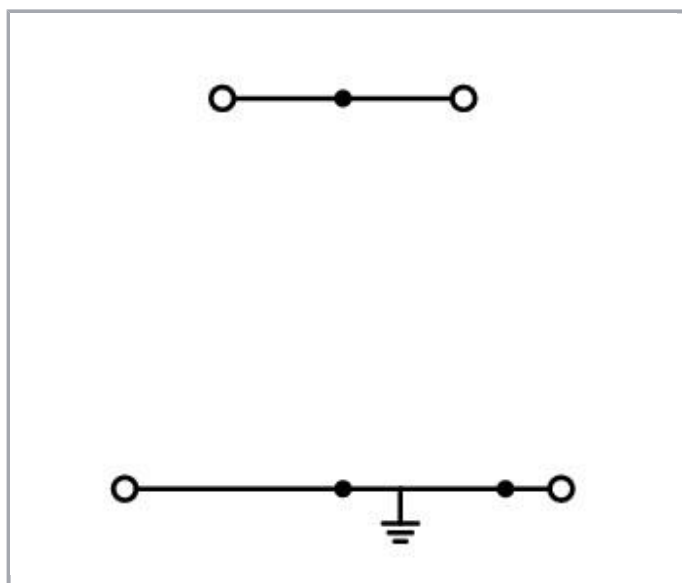
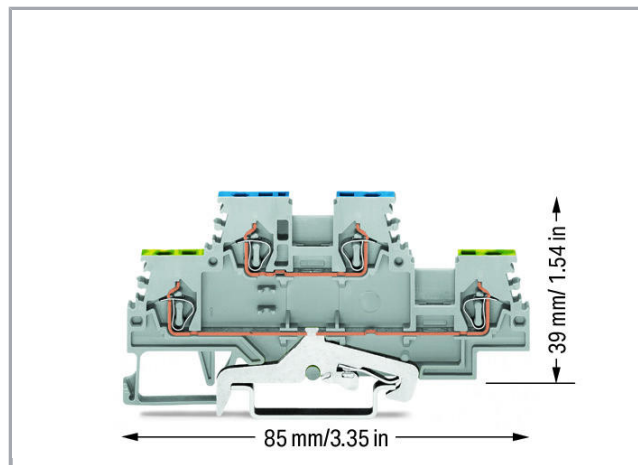
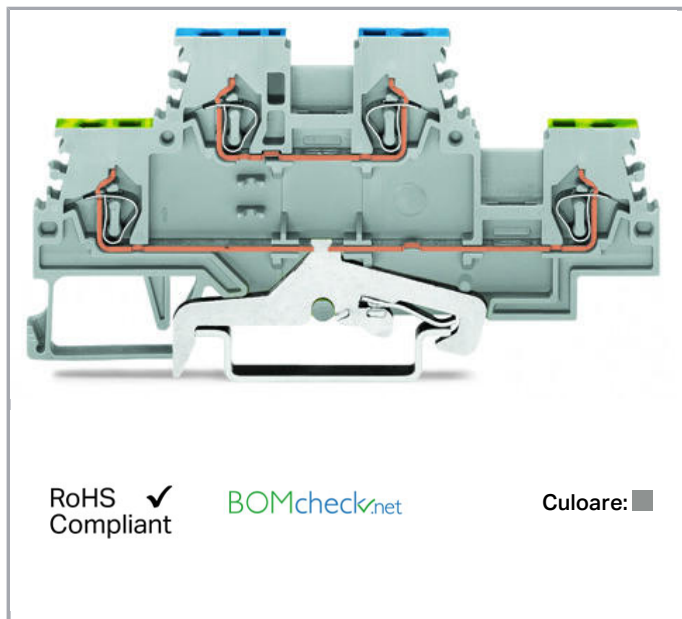

Date

Electrical data

Supus modificărilor.

WAGO Kontakttechnik GmbH & Co. KG
/Representative Office Romania
Sos. Pipera-Tunari nr. 1/1
building 1, 2nd floor | 077190 Voluntari, Ilfov
Tel.: +40-(0)31 421 85 68 | Email: info-RO@wago.com

Aveți întrebări despre produsele noastre?
Vă stăm la dispoziție pentru preluarea apelului la +40 (0) 31 421 85 68.



Ratings per IEC/EN 60664-1

| | |
|-----------------------------|---|
| Ratings per | IEC/EN 60947-7-1 |
| Nominal voltage (III/3) | 500 V |
| Rated surge voltage (III/3) | 6 kV |
| Rated current | 18 A |
| Legend (ratings) | (III / 3) ≙ Overvoltage category III / Pollution degree 3 |

Connection data

| | |
|-----------------------------------|--|
| Connection technology | CAGE CLAMP® |
| Actuation type | Operating tool |
| Connectable conductor materials | Copper |
| Solid conductor | 0,08 ... 1,5 mm ² / 28 ... 16 AWG |
| Fine-stranded conductor | 0,08 ... 1,5 mm ² / 28 ... 16 AWG |
| Strip length | 8 ... 9 mm / 0.31 ... 0.35 inch |
| Total number of connection points | 4 |
| Total number of potentials | 2 |
| Number of levels | 2 |
| Wiring type | Front-entry wiring |

Geometrical Data

| | |
|------------------------------------|--------------------|
| Width | 4 mm / 0.157 inch |
| Height from upper-edge of DIN-rail | 39 mm / 1.535 inch |
| Depth | 85 mm / 3.346 inch |

Mechanical data

| | |
|-------------------|-----------------|
| Design | horizontal type |
| Mounting type | DIN-35 rail |
| Potential marking | PE/N |
| Marking level | Side marking |

Material Data

| | |
|---------------------|----------------------|
| Color | gray |
| Insulation material | Polyamide 66 (PA 66) |
| Fire load | 0,137 MJ |
| Weight | 11,3 g |



Supus modificărilor.

Commercial data



| | |
|-----------------------|----------------------------------|
| Product Group | 1 (Rail Mounted Terminal Blocks) |
| Packaging type | BOX |
| Country of origin | DE |
| GTIN | 4050821109389 |
| Customs tariff number | 85369010000 |

Aprobări / certificate

Country specific Approvals

| Emblemă | Aprobare | Text de aprobare suplimentar | Nume certificat |
|--|--|------------------------------|-----------------|
|  | CCA DEKRA Certification B.V. | EN 60947 | NTR NL-7081 |
|  | CSA DEKRA Certification B.V. | C22.2 No. 158 | 70133738 |
|  | KEMA/KEUR DEKRA Certification B.V. | EN 60947 | 2160584.04 |

Ship Approvals

| Emblemă | Aprobare | Text de aprobare suplimentar | Nume certificat |
|--|---|------------------------------|------------------|
|  | ABS American Bureau of Shipping | - | 20-HG1941090-PDA |
|  | DNV GL Det Norske Veritas, Germanischer Lloyd | - | TAE00001V2 |

UL-Approvals

| Emblemă | Aprobare | Text de aprobare suplimentar | Nume certificat |
|---------|---|------------------------------|-----------------|
| | UR Underwriters Laboratories Inc. | UL 1059 | E45172 |

Supus modificărilor.

WAGO Kontakttechnik GmbH & Co. KG
/Representative Office Romania
Sos. Pipera-Tunari nr. 1/1
building 1, 2nd floor | 077190 Voluntari, Ilfov
Tel.: +40-(0)31 421 85 68 | Email: info-RO@wago.com

Aveți întrebări despre produsele noastre?
Vă stăm la dispoziție pentru preluarea apelului la +40 (0) 31 421 85 68.



Counterpart

Produce compatibile

Protective Warning Marker

**Nr. articol: 279-415**

Protective warning marker; with high-voltage symbol, black; for 5 terminal blocks; yellow

www.wago.com/279-415

General accessories

**Nr. articol: 279-529**

Adaptor; gray

www.wago.com/279-529

Insulation stop

**Nr. articol: 279-470**Insulation stop; 0.08 - 0.2 mm² "s" (0.14 mm² "f-st"); 5 pieces/strip; whitewww.wago.com/279-470**Nr. articol: 279-471**Insulation stop; 0.25 mm²; 5 pieces/strip; dark graywww.wago.com/279-471

Jumper

**Nr. articol: 210-103**















Wire commoning chain; insulated; 50 connections; black

www.wago.com/210-103**Nr. articol: 249-123**Push-in type wire jumper; insulated; wire length 180 mm; Conductor cross section 0.75 mm²www.wago.com/249-123**Nr. articol: 249-125**Push-in type wire jumper; insulated; wire length 60 mm; Conductor cross section 0.75 mm²www.wago.com/249-125**Nr. articol: 249-126**Push-in type wire jumper; insulated; wire length 110 mm; Conductor cross section 0.75 mm²www.wago.com/249-126

Supus modificărilor.

WAGO Kontakttechnik GmbH & Co. KG
 /Representative Office Romania
 Sos. Pipera-Tunari nr. 1/1
 building 1, 2nd floor | 077190 Voluntari, Ilfov
 Tel.: +40-(0)31 421 85 68 | Email: info-RO@wago.com

Aveți întrebări despre produsele noastre?
 Vă stăm la dispoziție pentru preluarea apelului la +40 (0) 31 421 85 68.

| | | |
|--|---|--|
|  | Nr. articol: 249-127 Push-in type wire jumper; insulated; wire length 250 mm; Conductor cross section 0.75 mm ² | www.wago.com/249-127 |
|  | Nr. articol: 279-402 Adjacent jumper; insulated; Nominal current 15 A; gray | www.wago.com/279-402 |
|  | Nr. articol: 279-409 Alternate jumper; insulated; Nominal current 15 A; gray | www.wago.com/279-409 |
|  | Nr. articol: 279-422 Adjacent jumper; insulated; Nominal current 15 A; yellow-green | www.wago.com/279-422 |
|  | Nr. articol: 279-482 Comb-style jumper bar; insulated; 2-way; IN = IN terminal block; gray | www.wago.com/279-482 |
|  | Nr. articol: 279-483 Comb-style jumper bar; insulated; 3-way; IN = IN terminal block; gray | www.wago.com/279-483 |
|  | Nr. articol: 279-490 Comb-style jumper bar; insulated; 10-way; IN = IN terminal block; gray | www.wago.com/279-490 |
|  | Nr. articol: 279-492 Alternate comb-style jumper bar; insulated; 2-way; IN = IN terminal block; gray | www.wago.com/279-492 |
| Carrier rail | | |
|  | Nr. articol: 210-112 Steel carrier rail; 35 x 7.5 mm; 1 mm thick; 2 m long; slotted; according to EN 60715; "Hole width 25 mm | www.wago.com/210-112 |
|  | Nr. articol: 210-113 Steel carrier rail; 35 x 7.5 mm; 1 mm thick; 2 m long; unslotted; according to EN 60715 | www.wago.com/210-113 |
|  | Nr. articol: 210-114 Steel carrier rail; 35 x 15 mm; 1.5 mm thick; 2 m long; unslotted; similar to EN 60715 | www.wago.com/210-114 |
| | Nr. articol: 210-115 Steel carrier rail; 35 x 7.5 mm; 1 mm thick; 2 m long; slotted; according to EN 60715; "Hole width 18 mm | www.wago.com/210-115 |
| | Nr. articol: 210-118 Steel carrier rail; 35 x 15 mm; 2.3 mm thick; 2 m long; unslotted; according to EN 60715 | www.wago.com/210-118 |
| | Nr. articol: 210-196 Aluminum carrier rail; 35 x 8.2 mm; 1.6 mm thick; 2 m long; unslotted; similar to EN 60715; silver-colored | www.wago.com/210-196 |
|  | Nr. articol: 210-197 Steel carrier rail; 35 x 15 mm; 1.5 mm thick; 2 m long; slotted; similar to EN 60715 | www.wago.com/210-197 |
|  | Nr. articol: 210-198 Copper carrier rail; 35 x 15 mm; 2.3 mm thick; 2 m long; unslotted; according to EN 60715; copper-colored | www.wago.com/210-198 |
|  | Nr. articol: 210-504 Steel carrier rail; 35 x 7.5 mm; 1 mm thick; 2 m long; slotted; galvanized; according to EN 60715 | www.wago.com/210-504 |

Supus modificărilor.

WAGO Kontakttechnik GmbH & Co. KG
/Representative Office Romania
Sos. Pipera-Tunari nr. 1/1
building 1, 2nd floor | 077190 Voluntari, Ilfov
Tel.: +40-(0)31 421 85 68 | Email: info-RO@wago.com

Aveți întrebări despre produsele noastre?
Vă stăm la dispoziție pentru preluarea apelului la +40 (0) 31 421 85 68.

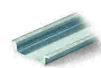
**Nr. articol: 210-505**

Steel carrier rail; 35 x 7.5 mm; 1 mm thick; 2 m long; unslotted; galvanized; according to EN 60715

www.wago.com/210-505**Nr. articol: 210-506**

Steel carrier rail; 35 x 15 mm; 1.5 mm thick; 2 m long; unslotted; galvanized; similar to EN 60715

www.wago.com/210-506**Nr. articol: 210-508**

Steel carrier rail; 35 x 15 mm; 1.5 mm thick; 2 m long; slotted; galvanized; similar to EN 60715

www.wago.com/210-508**ferrule****Nr. articol: 216-101**Ferrule; Sleeve for 0.5 mm² / AWG 22; uninsulated; electro-tin platedwww.wago.com/216-101**Nr. articol: 216-102**Ferrule; Sleeve for 0.75 mm² / AWG 20; uninsulated; electro-tin platedwww.wago.com/216-102**Nr. articol: 216-103**Ferrule; Sleeve for 1 mm² / AWG 18; uninsulated; electro-tin platedwww.wago.com/216-103**Nr. articol: 216-201**Ferrule; Sleeve for 0.5 mm² / 20 AWG; insulated; electro-tin plated; whitewww.wago.com/216-201**Nr. articol: 216-202**Ferrule; Sleeve for 0.75 mm² / 18 AWG; insulated; electro-tin plated; graywww.wago.com/216-202**Nr. articol: 216-203**Ferrule; Sleeve for 1 mm² / AWG 18; insulated; electro-tin plated; redwww.wago.com/216-203**Nr. articol: 216-301**Ferrule; Sleeve for 0.25 mm² / AWG 24; insulated; electro-tin plated; yellowwww.wago.com/216-301**Nr. articol: 216-302**Ferrule; Sleeve for 0.34 mm² / 22 AWG; insulated; electro-tin plated; greenwww.wago.com/216-302**End plate****Nr. articol: 209-192**

Separator for Ex e/Ex i applications; 3 mm thick; 125.5 mm wide; orange

www.wago.com/209-192**Nr. articol: 279-518**

End and intermediate plate; 2 mm thick; gray

www.wago.com/279-518**Nr. articol: 279-519**

End and intermediate plate; 2 mm thick; orange

www.wago.com/279-519**assembling****Nr. articol: 209-106**

Mounting carrier; for isolated mounting on DIN 35 rails; gray

www.wago.com/209-106**Nr. articol: 709-153**

Cover; Type 1; suitable for cover carrier, type 1; 1 m long; transparent

www.wago.com/709-153**tools**

Supus modificărilor.



Nr. articol: 210-647
Operating tool; Blade: 2.5 x 0.4 mm; with a partially insulated shaft

www.wago.com/210-647



Nr. articol: 210-648
Operating tool; Blade: 2.5 x 0.4 mm; with a partially insulated shaft; angled; short

www.wago.com/210-648



Nr. articol: 210-719
Operating tool; Blade: 2.5 x 0.4 mm; with a partially insulated shaft

www.wago.com/210-719

Marking accessories



Nr. articol: 2009-114
WMB-Inline; for Smart Printer; 2000 pieces on roll; stretchable 4 - 4.2 mm; plain; snap-on type; white

www.wago.com/2009-114



Nr. articol: 2009-114/000-002
WMB-Inline; for Smart Printer; 2000 pieces on roll; stretchable 4 - 4.2 mm; plain; snap-on type; yellow

www.wago.com/2009-114/000-002



Nr. articol: 2009-114/000-005
WMB-Inline; for Smart Printer; 2000 pieces on roll; stretchable 4 - 4.2 mm; plain; snap-on type; red

www.wago.com/2009-114/000-005



Nr. articol: 2009-114/000-006
WMB-Inline; for Smart Printer; 2000 pieces on roll; stretchable 4 - 4.2 mm; plain; snap-on type; blue

www.wago.com/2009-114/000-006



Nr. articol: 2009-114/000-007
WMB-Inline; for Smart Printer; 2000 pieces on roll; stretchable 4 - 4.2 mm; plain; snap-on type; gray

www.wago.com/2009-114/000-007



Nr. articol: 2009-114/000-012
WMB-Inline; for Smart Printer; 2000 pieces on roll; stretchable 4 - 4.2 mm; plain; snap-on type; orange

www.wago.com/2009-114/000-012



Nr. articol: 2009-114/000-023
WMB-Inline; for Smart Printer; 2000 pieces on roll; stretchable 4 - 4.2 mm; plain; snap-on type; green

www.wago.com/2009-114/000-023



Nr. articol: 2009-114/000-024
WMB-Inline; for Smart Printer; 2000 pieces on roll; stretchable 4 - 4.2 mm; plain; snap-on type; violet

www.wago.com/2009-114/000-024



Nr. articol: 209-128
Adaptor; gray

www.wago.com/209-128



Nr. articol: 209-140
Group marker carrier; gray

www.wago.com/209-140



Nr. articol: 209-141
Group marker carrier; gray

www.wago.com/209-141



Nr. articol: 209-142
Group marker carrier; gray

www.wago.com/209-142

Supus modificărilor.



Nr. articol: 209-185
Adaptor; gray

www.wago.com/209-185



Nr. articol: 249-105
Group marker carrier; gray

www.wago.com/249-105



Nr. articol: 793-4501
WMB marking card; as card; stretchable 4 - 4.2 mm; plain; snap-on type; white

www.wago.com/793-4501



Nr. articol: 793-4501/000-002
WMB marking card; as card; stretchable 4 - 4.2 mm; plain; snap-on type; yellow

www.wago.com/793-4501/000-002



Nr. articol: 793-4501/000-005
WMB marking card; as card; stretchable 4 - 4.2 mm; plain; snap-on type; red

www.wago.com/793-4501/000-005



Nr. articol: 793-4501/000-006
WMB marking card; as card; stretchable 4 - 4.2 mm; plain; snap-on type; blue

www.wago.com/793-4501/000-006



Nr. articol: 793-4501/000-007
WMB marking card; as card; stretchable 4 - 4.2 mm; plain; snap-on type; gray

www.wago.com/793-4501/000-007



Nr. articol: 793-4501/000-012
WMB marking card; as card; stretchable 4 - 4.2 mm; plain; snap-on type; orange

www.wago.com/793-4501/000-012



Nr. articol: 793-4501/000-017
WMB marking card; as card; stretchable 4 - 4.2 mm; plain; snap-on type; green

www.wago.com/793-4501/000-017



Nr. articol: 793-4501/000-023
WMB marking card; as card; stretchable 4 - 4.2 mm; plain; snap-on type; light green

www.wago.com/793-4501/000-023



Nr. articol: 793-4501/000-024
WMB marking card; as card; stretchable 4 - 4.2 mm; plain; snap-on type; violet

www.wago.com/793-4501/000-024

check



Nr. articol: 209-170
Test plug adapter; 8.3 mm wide; for 4 mm Ø test plugs; suitable for 1.5 mm² - 10 mm² tbs; gray

www.wago.com/209-170



Nr. articol: 280-404
Test plug adapter; 5 mm wide; for test plug 210-137 (2.3 mm Ø); suitable for 1.5 mm² - 4 mm² tbs; gray

www.wago.com/280-404

Supus modificărilor.

Descărcări Documentation

Additional Information

Technical explanations

Apr 3, 2019

pdf
2,1 MB

[Descărcare](#)

CAD/CAE-Data

CAD data

2D/3D Models 279-517

[URL](#)

[Descărcare](#)

CAE data

EPLAN Data Portal 279-517

[URL](#)

[Descărcare](#)

WSCAD Universe 279-517

[URL](#)

[Descărcare](#)

Installation Notes

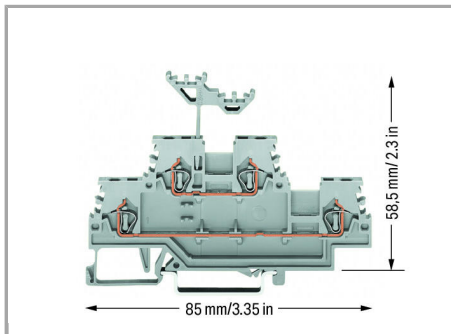

Double-deck marker carrier

(height including marker carrier)

Supus modificărilor.