

Fișă tehnică | Număr articol: 272-682
Power supply connector; 0,75 mm²; white

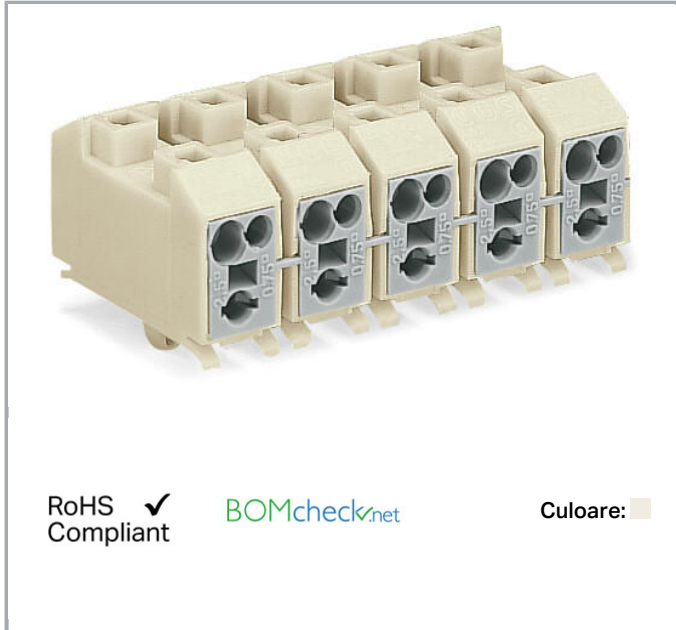

www.wago.com/272-682



RoHS Compliant

BOMcheck.net

Culoare:

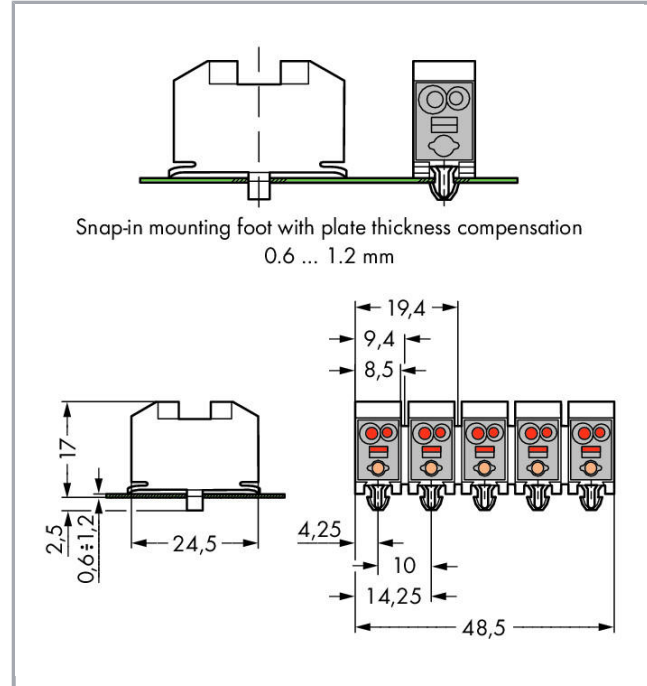

Snap-in mounting foot with plate thickness compensation
0.6 ... 1.2 mm

Date

Electrical data

Ratings per IEC/EN 60664-1

Rated voltage (III/2)	400 V
Rated surge voltage (III/2)	4 kV
Rated current	26 A
Legend (ratings)	(III / 2) ≙ Overvoltage category III / Pollution degree 2

Approvals per UL 1059

Approvals per	UL 1059
---------------	---------

Connection data

Connection technology	PUSH WIRE®
Strip length	8 ... 9 mm / 0.31 ... 0.35 inch

Supus modificărilor.

WAGO Kontakttechnik GmbH & Co. KG
/Representative Office Romania
Sos. Pipera-Tunari nr. 1/1
building 1, 2nd floor | 077190 Voluntari, Ilfov
Tel.: +40-(0)31 421 85 68 | Email: info-RO@wago.com

Aveți întrebări despre produsele noastre?
Vă stăm la dispoziție pentru preluarea apelului la +40 (0) 31 421 85 68.

Pole No.	2
Total number of connection points	8
Total number of potentials	2
Number of connection types	1

Geometrical Data

Width	18,5 mm / 0.728 inch
Height	19,5 mm / 0.767 inch
Depth	24,5 mm / 0.965 inch

Material Data



Color	white
Fire load	0,109 MJ
Weight	6,3 g

Commercial data

Product Group	8 (Misc. Chassis Mount Blocks)
Packaging type	bag
Country of origin	DE
GTIN	4044918434461
Customs tariff number	85369010000

Aprobări / certificate

Country specific Approvals





Emblemă	Aprobare	Text de aprobare suplimentar	Nume certificat
	CCA DEKRA Certification B.V.	EN 60998	NTR NL 7384
	CCA DEKRA Certification B.V.	EN 60998	2176190.01
	CSA DEKRA Certification B.V.	C22.2 No. 158	70048844

Supus modificărilor.

WAGO Kontakttechnik GmbH & Co. KG
/Representative Office Romania
Sos. Pipera-Tunari nr. 1/1
building 1, 2nd floor | 077190 Voluntari, Ilfov
Tel.: +40-(0)31 421 85 68 | Email: info-RO@wago.com

Aveți întrebări despre produsele noastre?
Vă stăm la dispoziție pentru preluarea apelului la +40 (0) 31 421 85 68.

Ship Approvals

Emblemă	Aprobare	Text de aprobare suplimentar	Nume certificat
	ABS American Bureau of Shipping	-	18- HG1755093- PDA
	BV Bureau Veritas S.A.	EN 60998	11914/C0 BV
	DNV GL Det Norske Veritas, Germanischer Lloyd	-	TAE000016Z
	LR Lloyds Register	IEC 61984	96/20035 (E5)

UL-Approvals

Emblemă	Aprobare	Text de aprobare suplimentar	Nume certificat
	UR Underwriters Laboratories Inc.	UL 1059	20190731- E45172

Counterpart

Produse compatibile

tools

	Nr. articol: 249-100 Operating tool; for terminal blocks with snap-in ground contact	www.wago.com/249-100
	Nr. articol: 271-120 Push-button; for retrofitting; loose	www.wago.com/271-120

assembling

Supus modificărilor.

WAGO Kontakttechnik GmbH & Co. KG
/Representative Office Romania
Sos. Pipera-Tunari nr. 1/1
building 1, 2nd floor | 077190 Voluntari, Ilfov
Tel.: +40-(0)31 421 85 68 | Email: info-RO@wago.com

Aveți întrebări despre produsele noastre?
Vă stăm la dispoziție pentru preluarea apelului la +40 (0) 31 421 85 68.



Nr. articol: 271-702

Pins; for plate thickness 1 mm

www.wago.com/271-702



Nr. articol: 271-711

Pins; for plate thickness 1 mm

www.wago.com/271-711



Nr. articol: 271-712

Pins; for plate thickness 1.5 mm

www.wago.com/271-712

Descărcări

Documentation

Additional Information

Technical explanations	Apr 3, 2019	pdf 3,6 MB	Descărcare
------------------------	-------------	---------------	------------

CAD/CAE-Data

CAE data

EPLAN Data Portal 272-682	URL	Descărcare
WSCAD Universe 272-682	URL	Descărcare

Installation Notes

Supus modificărilor.

WAGO Kontakttechnik GmbH & Co. KG
/Representative Office Romania
Sos. Pipera-Tunari nr. 1/1
building 1, 2nd floor | 077190 Voluntari, Ilfov
Tel.: +40-(0)31 421 85 68 | Email: info-RO@wago.com

Aveți întrebări despre produsele noastre?

Vă stăm la dispoziție pentru preluarea apelului la +40 (0) 31 421 85 68.