

Fișă tehnică | Număr articol: 2706-103/000-004

PCB terminal block; lever; 6 mm²; Pin spacing 7.5 mm; 3-pole; CAGE

CLAMP®; 6,00 mm²; black

www.wago.com/2706-103/000-004



RoHS Compliant

Culoare:

Current-Carrying Capacity Curve

Pin spacing: 7.5 mm / Conductor cross-section: 6 mm² "f-st"
Based on: EN 60512-5-2 / Reduction factor: 1

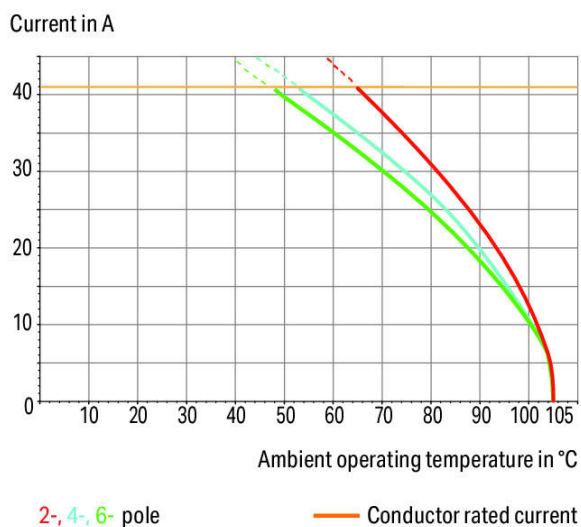

Supus modificărilor.

WAGO Kontakttechnik GmbH & Co. KG
/Representative Office Romania
Sos. Pipera-Tunari nr. 1/1
building 1, 2nd floor | 077190 Voluntari, Ilfov
Tel.: +40-(0)31 421 85 68 | Email: info-RO@wago.com

Aveți întrebări despre produsele noastre?
Vă stăm la dispoziție pentru preluarea apelului la +40 (0) 31 421 85 68.

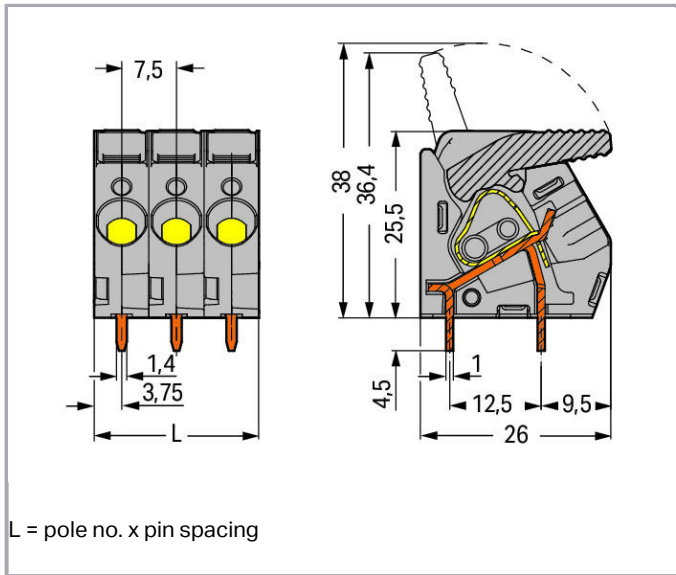

Descriere articol

- High-current PCB terminal strips with lever-actuated CAGE CLAMP® connection
- Tool-free termination – fingers open/close levers
- Several clamping units can be held open simultaneously – convenient for terminating multi-core cables
- Two solder pins per contact point for high mechanical stability
- 600 V UL for 12.5 mm pin spacing

Date

Electrical data

Ratings per IEC/EN 60664-1

| Ratings per | IEC/EN 60664-1 |
|-----------------------------|---|
| Nominal voltage (III/3) | 500 V |
| Rated surge voltage (III/3) | 6 kV |
| Rated voltage (III/2) | 630 V |
| Rated surge voltage (III/2) | 6 kV |
| Nominal voltage (II/2) | 1000 V |
| Rated surge voltage (II/2) | 6 kV |
| Rated current | 41 A |
| Legend (ratings) | (III / 2) ≙ Overvoltage category III / Pollution degree 2 |

Supus modificărilor.

WAGO Kontakttechnik GmbH & Co. KG
 /Representative Office Romania
 Sos. Pipera-Tunari nr. 1/1
 building 1, 2nd floor | 077190 Voluntari, Ilfov
 Tel.: +40-(0)31 421 85 68 | Email: info-RO@wago.com

Aveți întrebări despre produsele noastre?
 Vă stăm la dispoziție pentru preluarea apelului la +40 (0) 31 421 85 68.

Approvals per UL 1059

| | |
|--------------------------------|---------|
| Rated voltage UL (Use Group B) | 300 V |
| Rated current UL (Use Group B) | 30 A |
| Rated voltage UL (Use Group C) | 150 V |
| Rated current UL (Use Group C) | 30 A |
| Rated voltage UL (Use Group D) | 300 V |
| Rated current UL (Use Group D) | 30 A |
| Approvals per | UL 1059 |

Connection data

| | |
|---|---|
| Connection technology | CAGE CLAMP® |
| Actuation type | Lever |
| Solid conductor | 0,5 ... 6 mm ² / 20 ... 10 AWG |
| Fine-stranded conductor | 0,5 ... 6 mm ² / 20 ... 10 AWG |
| Fine-stranded conductor; with insulated ferrule | 0,5 ... 6 mm ² |
| Fine-stranded conductor; with uninsulated ferrule | 0,5 ... 6 mm ² |
| Strip length | 11 ... 12 mm / 0.43 ... 0.47 inch |
| Conductor connection direction to PCB | 30° |
| Pole No. | 3 |
| Total number of connection points | 3 |
| Total number of potentials | 3 |
| Number of connection types | 1 |
| Number of levels | 1 |

Geometrical Data

| | |
|--------------------------------------|--------------------------|
| Pin spacing | 7,5 mm / 0.295 inch |
| Width | 22,5 mm / 0.886 inch |
| Height | 30 mm / 1.181 inch |
| Height from the surface | 25,5 mm / 1.004 inch |
| Depth | 26 mm / 1.024 inch |
| Solder pin length | 4,5 mm |
| Solder pin dimensions | 1 x 1,4 mm |
| Drilled hole diameter with tolerance | 1,8 ^(+0,1) mm |

PCB contact

| | |
|-------------|-----|
| PCB contact | THT |
|-------------|-----|

Supus modificărilor.

WAGO Kontakttechnik GmbH & Co. KG
 /Representative Office Romania
 Sos. Pipera-Tunari nr. 1/1
 building 1, 2nd floor | 077190 Voluntari, Ilfov
 Tel.: +40-(0)31 421 85 68 | Email: info-RO@wago.com

Aveți întrebări despre produsele noastre?
 Vă stăm la dispoziție pentru preluarea apelului la +40 (0) 31 421 85 68.

| | |
|-------------------------------------|--|
| Solder pin arrangement | over the entire terminal strip (in-line) |
| Number of solder pins per potential | 2 |

Material Data

| | |
|-----------------------------|--|
| Color | black |
| Material group | I |
| Insulation material | Polyamide 66 (PA 66) |
| Flammability class per UL94 | V0 |
| Clamping spring material | Chrome nickel spring steel (CrNi) |
| Contact material | Electrolytic copper (E _{Cu}) |
| Contact plating | tin-plated |
| Fire load | 0,283 MJ |
| Weight | 15,5 g |

Environmental Requirements

| | |
|-------------------------|-----------------|
| Limit temperature range | -60 ... +105 °C |
|-------------------------|-----------------|

Commercial data

| | |
|-----------------------|---------------------|
| Product Group | 4 (Printed Circuit) |
| Packaging type | BOX |
| Country of origin | PL |
| GTIN | 4050821250418 |
| Customs tariff number | 85369010000 |

Aprobări / certificate

Country specific Approvals

| Emblemă | Aprobare | Text de aprobare suplimentar | Nume certificat |
|--|---------------------------------|------------------------------|-----------------|
|  | CSA DEKRA Certification B.V. | C22.2 No. 158 | 2516072 |

UL-Approvals

| Emblemă | Aprobare | Text de aprobare suplimentar | Nume certificat |
|---------|-------------------------------------|------------------------------|---------------------|
| | UL UL International Germany GmbH | UL 1059 | 20190731- E45172 |

Supus modificărilor.



Counterpart

Produse compatibile

check



Nr. articol: 210-136

Test plug; 2 mm Ø; with 500 mm cable; red

www.wago.com/210-136



Nr. articol: 210-137

Test plug; 2.3 mm Ø; with 500 mm cable; yellow

www.wago.com/210-137

ferrule



Nr. articol: 216-101

Ferrule; Sleeve for 0.5 mm² / AWG 22; uninsulated; electro-tin plated

www.wago.com/216-101



Nr. articol: 216-102

Ferrule; Sleeve for 0.75 mm² / AWG 20; uninsulated; electro-tin plated

www.wago.com/216-102



Nr. articol: 216-103

Ferrule; Sleeve for 1 mm² / AWG 18; uninsulated; electro-tin plated

www.wago.com/216-103



Nr. articol: 216-104

Ferrule; Sleeve for 1.5 mm² / AWG 16; uninsulated; electro-tin plated

www.wago.com/216-104



Nr. articol: 216-106

Ferrule; Sleeve for 2.5 mm² / AWG 14; uninsulated; electro-tin plated

www.wago.com/216-106



Nr. articol: 216-107

Ferrule; Sleeve for 4 mm² / AWG 12; uninsulated; electro-tin plated

www.wago.com/216-107



Nr. articol: 216-108

Ferrule; Sleeve for 6 mm² / AWG 10; uninsulated; electro-tin plated

www.wago.com/216-108



Nr. articol: 216-121

Ferrule; Sleeve for 0.5 mm² / AWG 22; uninsulated; electro-tin plated

www.wago.com/216-121



Nr. articol: 216-122

Ferrule; Sleeve for 0.75 mm² / AWG 20; uninsulated; electro-tin plated

www.wago.com/216-122



Nr. articol: 216-123

Ferrule; Sleeve for 1 mm² / AWG 18; uninsulated; electro-tin plated

















www.wago.com/216-123

Nr. articol: 216-124















Supus modificărilor.

WAGO Kontakttechnik GmbH & Co. KG
/Representative Office Romania
Sos. Pipera-Tunari nr. 1/1
building 1, 2nd floor | 077190 Voluntari, Ilfov
Tel.: +40-(0)31 421 85 68 | Email: info-RO@wago.com

Aveți întrebări despre produsele noastre?
Vă stăm la dispoziție pentru preluarea apelului la +40 (0) 31 421 85 68.

| | | |
|--|--|--|
|  | Ferrule; Sleeve for 1.5 mm ² / AWG 16; uninsulated; electro-tin plated | www.wago.com/216-124 |
|  | Nr. articol: 216-141 Ferrule; Sleeve for 0.5 mm ² / 20 AWG; uninsulated; electro-tin plated; electrolytic copper; gastight crimped; acc. to DIN 46228, Part 1/08.92 | www.wago.com/216-141 |
|  | Nr. articol: 216-142 Ferrule; Sleeve for 0.75 mm ² / 18 AWG; uninsulated; electro-tin plated; electrolytic copper; gastight crimped; acc. to DIN 46228, Part 1/08.92 | www.wago.com/216-142 |
|  | Nr. articol: 216-143 Ferrule; Sleeve for 1 mm ² / AWG 18; uninsulated; electro-tin plated; electrolytic copper; gastight crimped; acc. to DIN 46228, Part 1/08.92 | www.wago.com/216-143 |
|  | Nr. articol: 216-144 Ferrule; Sleeve for 1.5 mm ² / AWG 16; uninsulated; electro-tin plated; electrolytic copper; gastight crimped; acc. to DIN 46228, Part 1/08.92 | www.wago.com/216-144 |
|  | Nr. articol: 216-201 Ferrule; Sleeve for 0.5 mm ² / 20 AWG; insulated; electro-tin plated; white | www.wago.com/216-201 |
|  | Nr. articol: 216-202 Ferrule; Sleeve for 0.75 mm ² / 18 AWG; insulated; electro-tin plated; gray | www.wago.com/216-202 |
|  | Nr. articol: 216-203 Ferrule; Sleeve for 1 mm ² / AWG 18; insulated; electro-tin plated; red | www.wago.com/216-203 |
|  | Nr. articol: 216-204 Ferrule; Sleeve for 1.5 mm ² / AWG 16; insulated; electro-tin plated; black | www.wago.com/216-204 |
|  | Nr. articol: 216-205 Ferrule; Sleeve for 2.08 mm ² / AWG 14; insulated; electro-tin plated; yellow | www.wago.com/216-205 |
|  | Nr. articol: 216-206 Ferrule; Sleeve for 2.5 mm ² / AWG 14; insulated; electro-tin plated; blue | www.wago.com/216-206 |
|  | Nr. articol: 216-207 Ferrule; Sleeve for 4 mm ² / AWG 12; insulated; electro-tin plated; gray | www.wago.com/216-207 |
|  | Nr. articol: 216-208 Ferrule; Sleeve for 6 mm ² / AWG 10; insulated; electro-tin plated; electrolytic copper; gastight crimped; acc. to DIN 46228, Part 4/09.90; yellow | www.wago.com/216-208 |
|  | Nr. articol: 216-221 Ferrule; Sleeve for 0.5 mm ² / 20 AWG; insulated; electro-tin plated; white | www.wago.com/216-221 |
|  | Nr. articol: 216-222 Ferrule; Sleeve for 0.75 mm ² / 18 AWG; insulated; electro-tin plated; gray | www.wago.com/216-222 |
|  | Nr. articol: 216-223 Ferrule; Sleeve for 1 mm ² / AWG 18; insulated; electro-tin plated; red | www.wago.com/216-223 |
|  | Nr. articol: 216-224 Ferrule; Sleeve for 1.5 mm ² / AWG 16; insulated; electro-tin plated; black | www.wago.com/216-224 |
| | Nr. articol: 216-241 | |

Supus modificărilor.

| | | |
|---|--|--|
|  | Ferrule; Sleeve for 0.5 mm ² / 20 AWG; insulated; electro-tin plated; electrolytic copper; gastight crimped; acc. to DIN 46228, Part 4/09.90; white | www.wago.com/216-241 |
| | Nr. articol: 216-242 | |
|  | Ferrule; Sleeve for 0.75 mm ² / 18 AWG; insulated; electro-tin plated; electrolytic copper; gastight crimped; acc. to DIN 46228, Part 4/09.90; gray | www.wago.com/216-242 |
| | Nr. articol: 216-243 | |
|  | Ferrule; Sleeve for 1 mm ² / AWG 18; insulated; electro-tin plated; electrolytic copper; gastight crimped; acc. to DIN 46228, Part 4/09.90; red | www.wago.com/216-243 |
| | Nr. articol: 216-244 | |
|  | Ferrule; Sleeve for 1.5 mm ² / AWG 16; insulated; electro-tin plated; electrolytic copper; gastight crimped; acc. to DIN 46228, Part 4/09.90; black | www.wago.com/216-244 |
| | Nr. articol: 216-246 | |
|  | Ferrule; Sleeve for 2.5 mm ² / AWG 14; insulated; electro-tin plated; electrolytic copper; gastight crimped; acc. to DIN 46228, Part 4/09.90; blue | www.wago.com/216-246 |
| | Nr. articol: 216-262 | |
|  | Ferrule; Sleeve for 0.75 mm ² / 18 AWG; insulated; electro-tin plated; electrolytic copper; gastight crimped; acc. to DIN 46228, Part 4/09.90; gray | www.wago.com/216-262 |
| | Nr. articol: 216-263 | |
|  | Ferrule; Sleeve for 1 mm ² / AWG 18; insulated; electro-tin plated; electrolytic copper; gastight crimped; acc. to DIN 46228, Part 4/09.90; red | www.wago.com/216-263 |
| | Nr. articol: 216-264 | |
|  | Ferrule; Sleeve for 1.5 mm ² / AWG 16; insulated; electro-tin plated; electrolytic copper; gastight crimped; acc. to DIN 46228, Part 4/09.90; black | www.wago.com/216-264 |
| | Nr. articol: 216-266 | |
|  | Ferrule; Sleeve for 2.5 mm ² / AWG 14; insulated; electro-tin plated; electrolytic copper; gastight crimped; acc. to DIN 46228, Part 4/09.90; blue | www.wago.com/216-266 |
| | Nr. articol: 216-267 | |
|  | Ferrule; Sleeve for 4 mm ² / AWG 12; insulated; electro-tin plated; electrolytic copper; gastight crimped; acc. to DIN 46228, Part 4/09.90; gray | www.wago.com/216-267 |
| | Nr. articol: 216-284 | |
|  | Ferrule; Sleeve for 1.5 mm ² / AWG 16; insulated; electro-tin plated; electrolytic copper; gastight crimped; acc. to DIN 46228, Part 4/09.90; black | www.wago.com/216-284 |
| | Nr. articol: 216-286 | |
|  | Ferrule; Sleeve for 2.5 mm ² / AWG 14; insulated; electro-tin plated; electrolytic copper; gastight crimped; acc. to DIN 46228, Part 4/09.90; blue | www.wago.com/216-286 |
| | Nr. articol: 216-287 | |
|  | Ferrule; Sleeve for 4 mm ² / AWG 12; insulated; electro-tin plated; electrolytic copper; gastight crimped; acc. to DIN 46228, Part 4/09.90; gray | www.wago.com/216-287 |
| | Nr. articol: 216-288 | |
|  | Ferrule; Sleeve for 6 mm ² / AWG 10; insulated; electro-tin plated; electrolytic copper; gastight crimped; acc. to DIN 46228, Part 4/09.90; yellow | www.wago.com/216-288 |

Descărcări

Documentation

Additional Information

Supus modificărilor.

WAGO Kontakttechnik GmbH & Co. KG
 /Representative Office Romania
 Sos. Pipera-Tunari nr. 1/1
 building 1, 2nd floor | 077190 Voluntari, Ilfov
 Tel.: +40-(0)31 421 85 68 | Email: info-RO@wago.com

Aveți întrebări despre produsele noastre?
 Vă stăm la dispoziție pentru preluarea apelului la +40 (0) 31 421 85 68.



Technical explanations

Apr 3, 2019

pdf
3,6 MB

Descărcare

CAD/CAE-Data

CAD data

2D/3D Models 2706-103/000-004

URL

Descărcare

PCB Design

Symbol and Footprint 2706-103/000-004

URL

Descărcare

CAX data for your PCB design, consisting of "schematic symbols and PCB footprints", allow easy integration of the WAGO component into your development environment.

Supported formats:

- Accel EDA 14 & 15
- Altium 6 to current version
- Cadence Allegro
- DesignSpark
- Eagle Libraries
- KiCad
- Mentor Graphics BoardStation
- Mentor Graphics Design Architect
- Mentor Graphics Design Expedition 99 and 2000
- OrCAD 9.X PCB and Capture
- PADS PowerPCB 3, 3.5, 4.X, and 5.X
- PADS PowerPCB and PowerLogic 3.0
- PCAD 2000, 2001, 2002, 2004, and 2006
- Pulsonix 8.5 or newer
- STL
- 3D STEP
- TARGET 3001!
- View Logic ViewDraw
- Quadcept
- Zuken CadStar 3 and 4
- Zuken CR-5000 and CR-8000

PCB Component Libraries (EDA), PCB CAD Library Ultra Librarian

Supus modificărilor.

WAGO Kontakttechnik GmbH & Co. KG
/Representative Office Romania
Sos. Pipera-Tunari nr. 1/1
building 1, 2nd floor | 077190 Voluntari, Ilfov
Tel.: +40-(0)31 421 85 68 | Email: info-RO@wago.com

Aveți întrebări despre produsele noastre?
Vă stăm la dispoziție pentru preluarea apelului la +40 (0) 31 421 85 68.

Installation Notes

Conductor termination



To open the clamping unit, pull the operating lever all the way back – 2706 and 2716 Series.

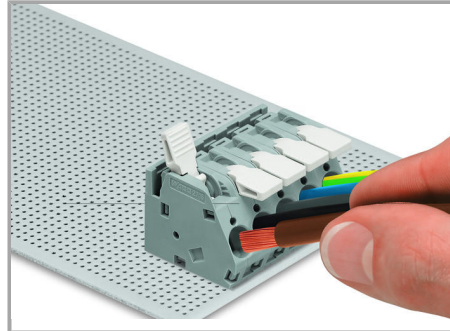

Inserting/removing a conductor – 2706 and 2716 Series.

Testing

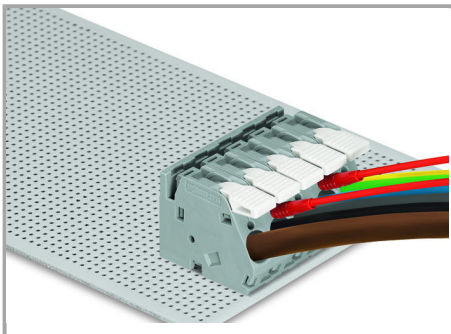

Testing with test plug – 2706 and 2716 Series.

Supus modificărilor.