

Fișă tehnică | Număr articol: 2626-3104/020-000

PCB terminal block; 6 mm<sup>2</sup>; Pin spacing 7.5 mm; 4-pole; Push-in CAGE CLAMP®; 6,00 mm<sup>2</sup>; gray

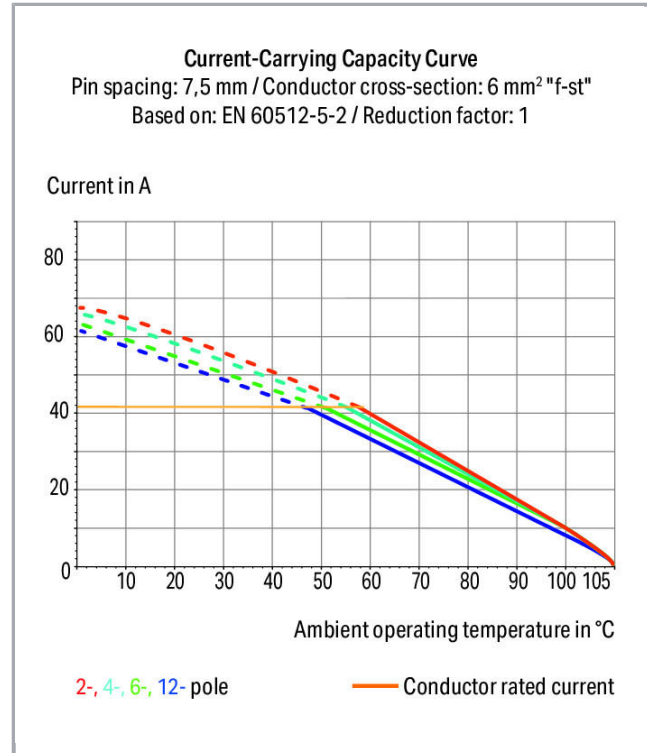

[www.wago.com/2626-3104/020-000](http://www.wago.com/2626-3104/020-000)

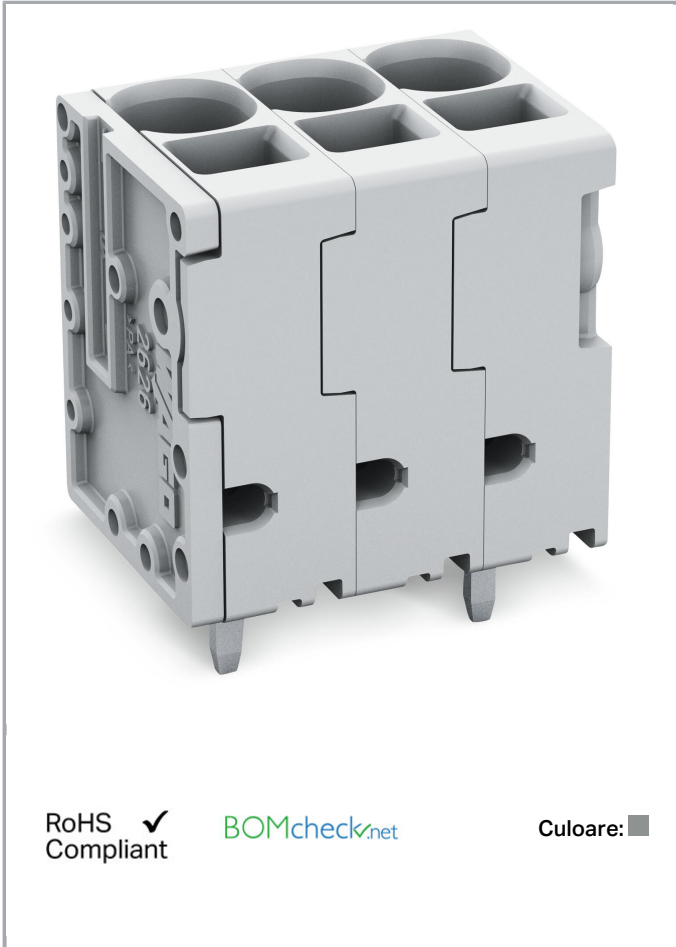

Supus modificărilor.

WAGO Kontakttechnik GmbH & Co. KG  
/Representative Office Romania  
Sos. Pipera-Tunari nr. 1/1  
building 1, 2nd floor | 077190 Voluntari, Ilfov  
Tel.: +40-(0)31 421 85 68 | Email: info-RO@wago.com

Aveți întrebări despre produsele noastre?  
Vă stăm la dispoziție pentru preluarea apelului la +40 (0) 31 421 85 68.

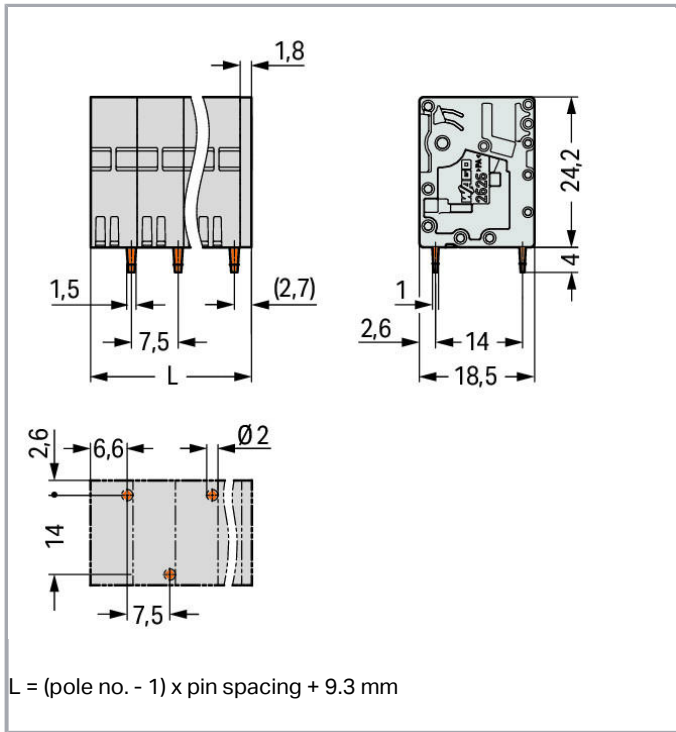

## Descriere articol

- PCB terminal strips with Push-in CAGE CLAMP® connection
- Push-in termination of solid and ferruled conductors
- Ideal for panel feedthrough applications via operation parallel to conductor entry
- Testing can be performed both parallel and perpendicular to conductor entry

## Date

### Electrical data

### Ratings per IEC/EN 60664-1

Ratings per	IEC/EN 60664-1
Nominal voltage (III/3)	800 V
Rated surge voltage (III/3)	8 kV
Rated voltage (III/2)	1000 V
Rated surge voltage (III/2)	8 kV
Nominal voltage (II/2)	1000 V
Rated surge voltage (II/2)	8 kV
Rated current	48 A
Legend (ratings)	(III / 2) ≙ Overvoltage category III / Pollution degree 2

Supus modificărilor.

WAGO Kontakttechnik GmbH & Co. KG  
 /Representative Office Romania  
 Sos. Pipera-Tunari nr. 1/1  
 building 1, 2nd floor | 077190 Voluntari, Ilfov  
 Tel.: +40-(0)31 421 85 68 | Email: info-RO@wago.com

Aveți întrebări despre produsele noastre?  
 Vă stăm la dispoziție pentru preluarea apelului la +40 (0) 31 421 85 68.



## Approvals per UL 1059

Rated voltage UL (Use Group B)	600 V
Rated current UL (Use Group B)	38 A
Rated voltage UL (Use Group C)	600 V
Rated current UL (Use Group C)	38 A
Approvals per	UL 1059

## Connection data

Connection technology	Push-in CAGE CLAMP®
Actuation type	Operating tool
Solid conductor	0.2 ... 10 mm <sup>2</sup> / 24 ... 8 AWG
Fine-stranded conductor	0.2 ... 10 mm <sup>2</sup> / 24 ... 8 AWG
Fine-stranded conductor; with insulated ferrule	0.25 ... 6 mm <sup>2</sup>
Fine-stranded conductor; with uninsulated ferrule	0.25 ... 6 mm <sup>2</sup>
Fine-stranded conductor; with twin ferrule	0.25 ... 2.5 mm <sup>2</sup>
Strip length	13 ... 15 mm / 0.51 ... 0.59 inch
Conductor connection direction to PCB	90°
Pole No.	4
Total number of connection points	4
Total number of potentials	4
Number of connection types	1
Number of levels	1

## Geometrical Data

Pin spacing	7.5 mm / 0.295 inch
Width	31.8 mm / 1.252 inch
Height	28.2 mm / 1.11 inch
Height from the surface	24.2 mm / 0.953 inch
Depth	18.5 mm / 0.728 inch
Solder pin length	4 mm
Solder pin dimensions	1.5 x 1 mm
Drilled hole diameter with tolerance	2 <sup>(+0.1)</sup> mm

## Mechanical data

Mounting type	Feed-through mounting
---------------	-----------------------

Supus modificărilor.

WAGO Kontakttechnik GmbH & Co. KG  
 /Representative Office Romania  
 Sos. Pipera-Tunari nr. 1/1  
 building 1, 2nd floor | 077190 Voluntari, Ilfov  
 Tel.: +40-(0)31 421 85 68 | Email: info-RO@wago.com

Aveți întrebări despre produsele noastre?  
 Vă stăm la dispoziție pentru preluarea apelului la +40 (0) 31 421 85 68.

## PCB contact

PCB contact	THT
Solder pin arrangement	over the entire terminal strip, staggered
Number of solder pins per potential	1

## Material Data

Color	gray
Material group	I
Insulation material	Polyamide 66 (PA 66)
Flammability class per UL94	V0
Clamping spring material	Chrome nickel spring steel (CrNi)
Contact material	Electrolytic copper (E <sub>Cu</sub> )
Contact plating	tin-plated
Weight	15,5 g

## Environmental Requirements



Limit temperature range	-60 ... +105 °C
-------------------------	-----------------

## Commercial data

Packaging type	BOX
Country of origin	DE
GTIN	4055143587327
Customs tariff number	85369010000

## Aprobări / certificate

### Country specific Approvals

Embleă	Aprobare	Text de aprobare suplimentar	Nume certificat
	CSA DEKRA Certification B.V.	C22.2	70146882
	KEMA/KEUR DEKRA Certification B.V.	EN 60947-7-4	71- 107864

Supus modificărilor.

WAGO Kontakttechnik GmbH & Co. KG  
/Representative Office Romania  
Sos. Pipera-Tunari nr. 1/1  
building 1, 2nd floor | 077190 Voluntari, Ilfov  
Tel.: +40-(0)31 421 85 68 | Email: info-RO@wago.com

Aveți întrebări despre produsele noastre?  
Vă stăm la dispoziție pentru preluarea apelului la +40 (0) 31 421 85 68.







## UL-Approvals

Emblemă	Aprobare	Text de aprobare suplimentar	Nume certificat
	cURus Underwriters Laboratories Inc.	UL 1059	20190731- E45172

## Counterpart

## Produse compatibile

## ferrule

	<b>Nr. articol: 216-108</b> Ferrule; Sleeve for 6 mm <sup>2</sup> / AWG 10; uninsulated; electro-tin plated	<a href="http://www.wago.com/216-108">www.wago.com/216-108</a>
	<b>Nr. articol: 216-208</b> Ferrule; Sleeve for 6 mm <sup>2</sup> / AWG 10; insulated; electro-tin plated; electrolytic copper; gastight crimped; acc. to DIN 46228, Part 4/09.90; yellow	<a href="http://www.wago.com/216-208">www.wago.com/216-208</a>
	<b>Nr. articol: 216-263</b> Ferrule; Sleeve for 1 mm <sup>2</sup> / AWG 18; insulated; electro-tin plated; electrolytic copper; gastight crimped; acc. to DIN 46228, Part 4/09.90; red	<a href="http://www.wago.com/216-263">www.wago.com/216-263</a>
	<b>Nr. articol: 216-264</b> Ferrule; Sleeve for 1.5 mm <sup>2</sup> / AWG 16; insulated; electro-tin plated; electrolytic copper; gastight crimped; acc. to DIN 46228, Part 4/09.90; black	<a href="http://www.wago.com/216-264">www.wago.com/216-264</a>
	<b>Nr. articol: 216-266</b> Ferrule; Sleeve for 2.5 mm <sup>2</sup> / AWG 14; insulated; electro-tin plated; electrolytic copper; gastight crimped; acc. to DIN 46228, Part 4/09.90; blue	<a href="http://www.wago.com/216-266">www.wago.com/216-266</a>
	<b>Nr. articol: 216-267</b> Ferrule; Sleeve for 4 mm <sup>2</sup> / AWG 12; insulated; electro-tin plated; electrolytic copper; gastight crimped; acc. to DIN 46228, Part 4/09.90; gray	<a href="http://www.wago.com/216-267">www.wago.com/216-267</a>

## tools

	<b>Nr. articol: 210-721</b> Operating tool; Blade: 5.5 x 0.8 mm; with a partially insulated shaft	<a href="http://www.wago.com/210-721">www.wago.com/210-721</a>
--	--	--

## Descărcări

## Documentation

## Additional Information

Technical explanations	Apr 3, 2019	pdf 3,6 MB	Descărcare
------------------------	-------------	---------------	------------

Supus modificărilor.

WAGO Kontakttechnik GmbH & Co. KG  
/Representative Office Romania  
Sos. Pipera-Tunari nr. 1/1  
building 1, 2nd floor | 077190 Voluntari, Ilfov  
Tel.: +40-(0)31 421 85 68 | Email: info-RO@wago.com

Aveți întrebări despre produsele noastre?  
Vă stăm la dispoziție pentru preluarea apelului la +40 (0) 31 421 85 68.



## CAD/CAE-Data

### CAD data

2D/3D Models 2626-3104/020-000	<a href="#">URL</a>	<a href="#">Descărcare</a>
--------------------------------	---------------------	----------------------------

### PCB Design

Symbol and Footprint 2626-3104/020-000	<a href="#">URL</a>	<a href="#">Descărcare</a>
--	---------------------	----------------------------

CAX data for your PCB design, consisting of "schematic symbols and PCB footprints", allow easy integration of the WAGO component into your development environment.

### Supported formats:

- Accel EDA 14 & 15
- Altium 6 to current version
- Cadence Allegro
- DesignSpark
- Eagle Libraries
- KiCad
- Mentor Graphics BoardStation
- Mentor Graphics Design Architect
- Mentor Graphics Design Expedition 99 and 2000
- OrCAD 9.X PCB and Capture
- PADS PowerPCB 3, 3.5, 4.X, and 5.X
- PADS PowerPCB and PowerLogic 3.0
- PCAD 2000, 2001, 2002, 2004, and 2006
- Pulsonix 8.5 or newer
- STL
- 3D STEP
- TARGET 3001!
- View Logic ViewDraw
- Quadcept
- Zuken CadStar 3 and 4
- Zuken CR-5000 and CR-8000

PCB Component Libraries (EDA), PCB CAD Library Ultra Librarian

Supus modificărilor.

WAGO Kontakttechnik GmbH & Co. KG  
/Representative Office Romania  
Sos. Pipera-Tunari nr. 1/1  
building 1, 2nd floor | 077190 Voluntari, Ilfov  
Tel.: +40-(0)31 421 85 68 | Email: info-RO@wago.com

Aveți întrebări despre produsele noastre?  
Vă stăm la dispoziție pentru preluarea apelului la +40 (0) 31 421 85 68.



## Installation Notes

Supus modificărilor.

---

WAGO Kontakttechnik GmbH & Co. KG  
/Representative Office Romania  
Sos. Pipera-Tunari nr. 1/1  
building 1, 2nd floor | 077190 Voluntari, Ilfov  
Tel.: +40-(0)31 421 85 68 | Email: info-RO@wago.com

Aveți întrebări despre produsele noastre?  
Vă stăm la dispoziție pentru preluarea apelului la +40 (0) 31 421 85 68.