

### Descriere articol

- Protected against mismatching and maintenance-free
- Push-in CAGE CLAMP® spring pressure connection technology allows solid conductors to be simply pushed into a unit
- Compact design with 4.4 mm pole spacing
- Components can be clearly printed on and color-coded to meet custom requirements
- When assembled, the installation connectors complies with IP40 and are suitable for easily accessible areas

Supus modificărilor.

**Note:**

All connectors for mounted installations (snap-in versions for lighting fixtures or devices, all types of PCB and distribution connectors) are factory-equipped with locking levers to ensure plugs and sockets are securely locked. Additional locking levers are only required for flying leads (plug /socket).

**Note on mismatching protection:**

All WINSTA<sup>®</sup> components are 100% protected against mismatching when:

- a.) plugging different numbers of poles
- b.) plugging while rotated 180
- c.) plugging while laterally staggered
- d.) plugging one pole

**Safety information 1:**

Application note for the U.S. market (USR): Some versions may also be used for current interruption in accordance with the UL certificate in select applications with currents below 5 A and voltages up to 600 V. For further information, please contact your local sales office.

**Date****Electrical data**

Note on Contact Resistance	approx. 1 mΩ of contact resistance approx. 0.25 mΩ contact transition plug/socket
----------------------------	---

**Ratings per IEC/EN 60664-1**

Ratings per	IEC/EN 60664-1
Nominal voltage (III/3)	400 V
Rated surge voltage (III/3)	6 kV
Rated current	16 A
Note on rated current	13 A for 3-pole load 10 A for 4-pole load
Legend (ratings)	(III / 3) ≙ Overvoltage category III / Pollution degree 3

**Approvals per UL 1977**

Rated voltage UL 1977	600 V
Rated current UL 1977	12 A

**Connection data**

Connection technology	Push-in CAGE CLAMP <sup>®</sup>
Actuation type	Operating tool Push-in
Nominal cross-section	1,5 mm <sup>2</sup>
Solid conductor	0,25 ... 1,5 mm <sup>2</sup> / 22 ... 16 AWG
Solid conductor; push-in termination	0,75 ... 1,5 mm <sup>2</sup> / 20 ... 16 AWG

Supus modificărilor.

WAGO Kontakttechnik GmbH & Co. KG  
/Representative Office Romania  
Sos. Pipera-Tunari nr. 1/1  
building 1, 2nd floor | 077190 Voluntari, Ilfov  
Tel.: +40-(0)31 421 85 68 | Email: info-RO@wago.com

Aveți întrebări despre produsele noastre?  
Vă stăm la dispoziție pentru preluarea apelului la +40 (0) 31 421 85 68.



Stranded conductor	0,25 ... 1 mm <sup>2</sup> / 22 ... 18 AWG
Fine-stranded conductor	0,25 ... 1,5 mm <sup>2</sup> / 22 ... 16 AWG
Fine-stranded conductor; with insulated ferrule	0,25 ... 0,75 mm <sup>2</sup> / 22 ... 20 AWG
Fine-stranded conductor; with uninsulated ferrule	0,25 ... 0,75 mm <sup>2</sup> / 22 ... 20 AWG
Fine-stranded conductor; with ferrule; push-in termination	0,75 mm <sup>2</sup> / 20 AWG
Strip length	9 mm / 0.35 inch
Note (strip length)	see also packaging or instructions
Pole No.	4
Total number of connection points	4
Total number of potentials	4
Conductor entry direction to mating direction	0°

### Geometrical Data

Pin spacing	4,4 mm / 0.173 inch
Width	28,6 mm / 1.126 inch
Height	16 mm / 0.63 inch
Depth	39,8 mm / 1.567 inch

### Mechanical data

Coding	B
Mating force of a plug-in connection	approx. 20 ... 70 N (depending on pole number)
Retention force of a plug-in connection	Locked: > 80 N
Unmating force of a plug-in connection	Unlocked: approx. 20 ... 70 N (depending on pole number)
Number of mating cycles	200, without resistive load 100, with resistive load $I_N = 16$ A, tested (1.5 mm <sup>2</sup> /16 AWG)
Housing sheet thickness	0,5 ... 2 mm / 0.02 ... 0.079 inch
Mounting type	Snap-in
Marking	3 PE 2 1
Protection type	IP20
Note on protection type	IP40 when mated
Potential marking	3 PE 2 1

### Plug connection

Contact type (pluggable connector)	Male connector/plug
------------------------------------	---------------------

Supus modificărilor.

Connector (connection type)	for conductor
Mismating protection	Yes
Locking of plug-in connection	locking lever
Locking lever	yes

### Material Data

Color	gray
Insulation material	Polyamide 66 (PA 66)
Clamping spring material	Chrome nickel spring steel (CrNi)
Contact material	Copper or copper alloy (surface-treated)
Weight	6,9 g

### Environmental Requirements

Processing temperature	-5 ... +40 °C
Continuous operating temperature	-35 ... +85 °C
Note on continuous operating temperature	Insulating parts for temperatures ≤ 105 °C

### Commercial data

Packaging type	BOX
Country of origin	PL
GTIN	4055143427999
Customs tariff number	85366990990

### Aprobări / certificate

#### Country specific Approvals

Emblemă	Aprobare	Text de aprobare suplimentar	Nume certificat
	<b>CB</b> DEKRA Certification B.V.	EN 61984	71- 100413

#### Ship Approvals

Emblemă	Aprobare	Text de aprobare suplimentar	Nume certificat
	<b>LR</b> Lloyds Register	EN 61535	08 /20047 (E2)

Supus modificărilor.

## Counterpart



Nr. articol 890-244/062-000

Socket; 4-pole; Cod. B; 1,50 mm<sup>2</sup>; gray

[www.wago.com/890-244/062-000](http://www.wago.com/890-244/062-000)

## Produse compatibile

### tools



Nr. articol: 210-719

Operating tool; Blade: 2.5 x 0.4 mm; with a partially insulated shaft

[www.wago.com/210-719](http://www.wago.com/210-719)

## Descărcări

### CAD/CAE-Data

#### CAD data

2D/3D Models 890-754/062-000

[URL](#)

[Descărcare](#)

#### CAE data

EPLAN Data Portal 890-754/062-000

[URL](#)

[Descărcare](#)

WSCAD Universe 890-754/062-000

[URL](#)

[Descărcare](#)

## Installation Notes

Supus modificărilor.

WAGO Kontakttechnik GmbH & Co. KG  
/Representative Office Romania  
Sos. Pipera-Tunari nr. 1/1  
building 1, 2nd floor | 077190 Voluntari, Ilfov  
Tel.: +40-(0)31 421 85 68 | Email: [info-RO@wago.com](mailto:info-RO@wago.com)

Aveți întrebări despre produsele noastre?

Vă stăm la dispoziție pentru preluarea apelului la +40 (0) 31 421 85 68.

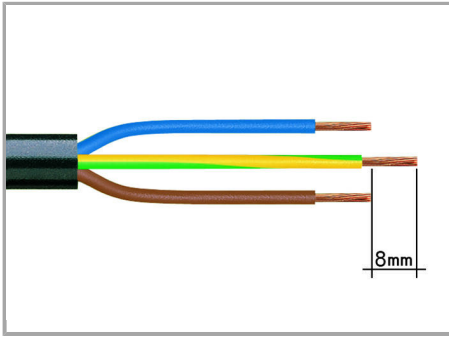

1. Strip length, outer insulation = 30 mm (2-pole), 37 mm (3-pole), 45 mm (4- and 5-pole)

2. Strip length = 9 mm

3. Extended ground conductor = 8 mm

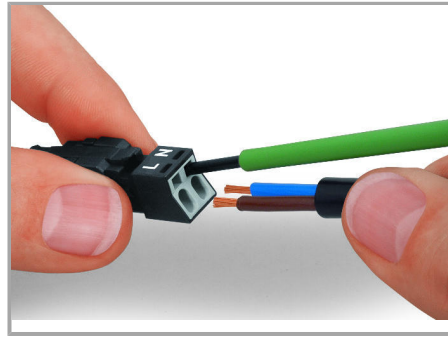

To terminate fine-stranded conductors, open the clamping unit via screwdriver (2.5 mm blade width) and insert a stripped conductor until it hits backstop. Terminate solid conductors by simply pushing them in.

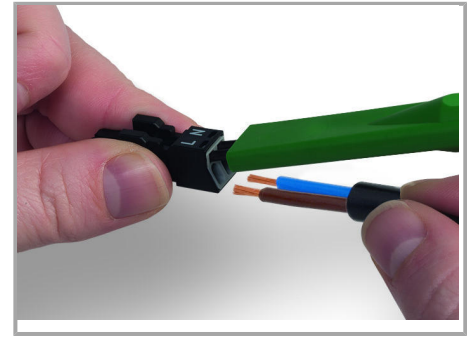

To terminate fine-stranded conductors, open clamping units via operating tool (890-382) and insert stripped conductors until they hit backstop.

Terminate solid conductors by simply pushing them in.

Supus modificărilor.

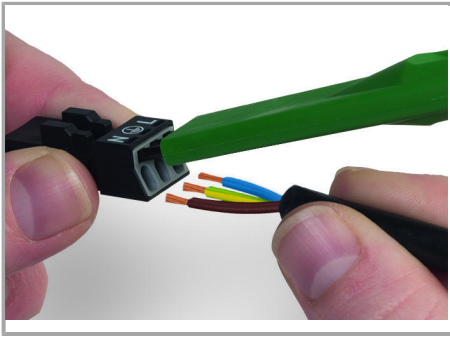

To terminate fine-stranded conductors, open clamping units via operating tool (890-383) and insert stripped conductors until they hit backstop.

Terminate solid conductors by simply pushing them in.

#### Mismatching protection

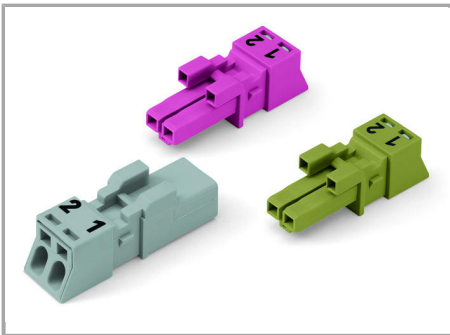

B-coded connectors with different colors can be plugged together.

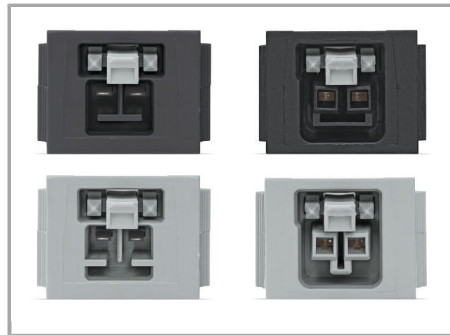

B-coded connectors (shown in gray) not only differ in color, but also in their design, making them incompatible with other coded connectors.



#### Important note:

Different colors and/or pole marking are used for circuit identification.

Only connectors of the same color and same pole marking must be plugged together.

#### Familie de produse

<i>WINSTA</i>® MINI special

Afișare globală produse din familie.

Supus modificărilor.