

Fișă tehnică | Număr articol: 261-423/331-000

2-conductor terminal strip; 3-pole; on one side with push-buttons; with fixing flanges; for screw or similar mounting types; Fixing hole 3.2 mm Ø; 2.5 mm²; CAGE CLAMP®; 2,50 mm²; gray

www.wago.com/261-423/331-000

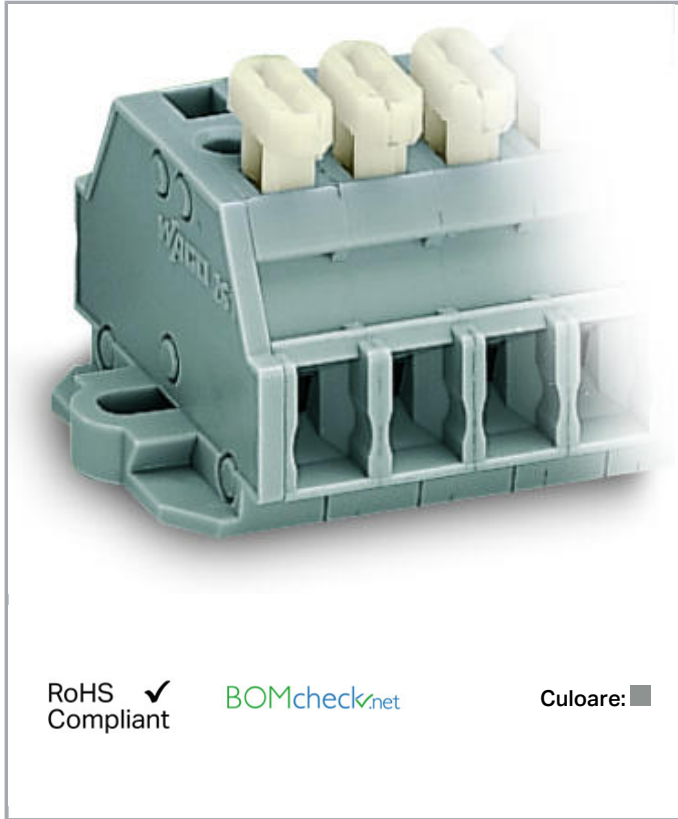

RoHS Compliant

BOMcheck.net

Culoare: ■

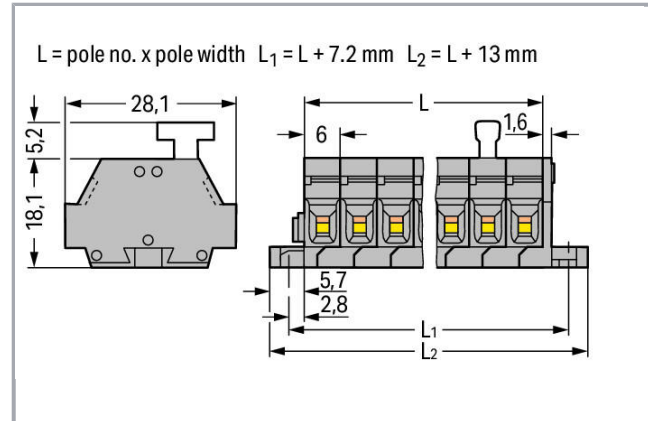

Date

Electrical data

Ratings per IEC/EN 60664-1

Nominal voltage (III/3)	500 V
Rated surge voltage (III/3)	6 kV
Rated current	24 A
Legend (ratings)	(III / 3) ≙ Overvoltage category III / Pollution degree 3

Connection data

Connection technology	CAGE CLAMP®
Actuation type	Operating tool

Supus modificărilor.

WAGO Kontakttechnik GmbH & Co. KG
/Representative Office Romania
Sos. Pipera-Tunari nr. 1/1
building 1, 2nd floor | 077190 Voluntari, Ilfov
Tel.: +40-(0)31 421 85 68 | Email: info-RO@wago.com

Aveți întrebări despre produsele noastre?
Vă stăm la dispoziție pentru preluarea apelului la +40 (0) 31 421 85 68.



	Push-button
Connectable conductor materials	Copper
Solid conductor	0,08 ... 2,5 mm ² / 28 ... 14 AWG
Fine-stranded conductor	0,08 ... 2,5 mm ² / 28 ... 14 AWG
Strip length	8 ... 9 mm / 0.31 ... 0.35 inch
Pole No.	3
Total number of connection points	6
Total number of potentials	3
Number of levels	1
Wiring type	Side-entry wiring

Geometrical Data

Width	31,6 mm / 1.244 inch
Height from the surface	23,2 mm / 0.913 inch
Depth	28 mm / 1.102 inch
Module width	6 mm / 0.236 inch

Mechanical data

Design	horizontal type
Mounting type	Mounting flange
Marking level	Side marking

Material Data

Color	gray
Fire load	0,177 MJ
Weight	8,7 g

Commercial data

Packaging type	BOX
Country of origin	DE
GTIN	4044918626798
Customs tariff number	85369010000

Counterpart









Supus modificărilor.

WAGO Kontakttechnik GmbH & Co. KG
 /Representative Office Romania
 Sos. Pipera-Tunari nr. 1/1
 building 1, 2nd floor | 077190 Voluntari, Ilfov
 Tel.: +40-(0)31 421 85 68 | Email: info-RO@wago.com

Aveți întrebări despre produsele noastre?
 Vă stăm la dispoziție pentru preluarea apelului la +40 (0) 31 421 85 68.

Produse compatibile

Marking accessories

	Nr. articol: 2009-145 Mini-WSB Inline; for Smart Printer; 1700 pieces on roll; stretchable 5 - 5.2 mm; plain; snap-on type; white	www.wago.com/2009-145
	Nr. articol: 2009-145/000-002 Mini-WSB Inline; for Smart Printer; 1700 pieces on roll; stretchable 5 - 5.2 mm; plain; snap-on type; yellow	www.wago.com/2009-145/000-002
	Nr. articol: 2009-145/000-005 Mini-WSB Inline; for Smart Printer; 1700 pieces on roll; stretchable 5 - 5.2 mm; plain; snap-on type; red	www.wago.com/2009-145/000-005
	Nr. articol: 2009-145/000-006 Mini-WSB Inline; for Smart Printer; 1700 pieces on roll; stretchable 5 - 5.2 mm; plain; snap-on type; blue	www.wago.com/2009-145/000-006
	Nr. articol: 2009-145/000-007 Mini-WSB Inline; for Smart Printer; 1700 pieces on roll; stretchable 5 - 5.2 mm; plain; snap-on type; grey	www.wago.com/2009-145/000-007
	Nr. articol: 2009-145/000-012 Mini-WSB Inline; for Smart Printer; 1700 pieces on roll; stretchable 5 - 5.2 mm; plain; snap-on type; orange	www.wago.com/2009-145/000-012
	Nr. articol: 2009-145/000-023 Mini-WSB Inline; for Smart Printer; 1700 pieces on roll; stretchable 5 - 5.2 mm; plain; snap-on type; green	www.wago.com/2009-145/000-023
	Nr. articol: 2009-145/000-024 Mini-WSB Inline; for Smart Printer; 1700 pieces on roll; stretchable 5 - 5.2 mm; plain; snap-on type; violet	www.wago.com/2009-145/000-024
	Nr. articol: 248-501 Miniature WSB Quick marking system; plain; Marker width 5 mm; 10 strips with 10 markers per card	www.wago.com/248-501
	Nr. articol: 248-501/000-002 Mini-WSB marking card; as card; not stretchable; plain; snap-on type; yellow	www.wago.com/248-501/000-002
	Nr. articol: 248-501/000-005 Mini-WSB marking card; as card; not stretchable; plain; snap-on type; red	www.wago.com/248-501/000-005

Supus modificărilor.

WAGO Kontakttechnik GmbH & Co. KG
/Representative Office Romania
Sos. Pipera-Tunari nr. 1/1
building 1, 2nd floor | 077190 Voluntari, Ilfov
Tel.: +40-(0)31 421 85 68 | Email: info-RO@wago.com

Aveți întrebări despre produsele noastre?
Vă stăm la dispoziție pentru preluarea apelului la +40 (0) 31 421 85 68.



Nr. articol: 248-501/000-006
Mini-WSB marking card; as card; not stretchable; plain; snap-on type; blue

www.wago.com/248-501/000-006



Nr. articol: 248-501/000-007
Mini-WSB marking card; as card; not stretchable; plain; snap-on type; gray

www.wago.com/248-501/000-007



Nr. articol: 248-501/000-012
Mini-WSB marking card; as card; not stretchable; plain; snap-on type; orange

www.wago.com/248-501/000-012



Nr. articol: 248-501/000-017
Mini-WSB marking card; as card; not stretchable; plain; snap-on type; light green

www.wago.com/248-501/000-017



Nr. articol: 248-501/000-023
Mini-WSB marking card; as card; not stretchable; plain; snap-on type; green

www.wago.com/248-501/000-023



Nr. articol: 248-501/000-024
Mini-WSB marking card; as card; not stretchable; plain; snap-on type; violet

www.wago.com/248-501/000-024

ferrule



Nr. articol: 216-101
Ferrule; Sleeve for 0.5 mm² / AWG 22; uninsulated; electro-tin plated

www.wago.com/216-101



Nr. articol: 216-102
Ferrule; Sleeve for 0.75 mm² / AWG 20; uninsulated; electro-tin plated

www.wago.com/216-102



Nr. articol: 216-103
Ferrule; Sleeve for 1 mm² / AWG 18; uninsulated; electro-tin plated

www.wago.com/216-103



Nr. articol: 216-104
Ferrule; Sleeve for 1.5 mm² / AWG 16; uninsulated; electro-tin plated

www.wago.com/216-104



Nr. articol: 216-106
Ferrule; Sleeve for 2.5 mm² / AWG 14; uninsulated; electro-tin plated

www.wago.com/216-106



Nr. articol: 216-121
Ferrule; Sleeve for 0.5 mm² / AWG 22; uninsulated; electro-tin plated

www.wago.com/216-121



Nr. articol: 216-122
Ferrule; Sleeve for 0.75 mm² / AWG 20; uninsulated; electro-tin plated

www.wago.com/216-122



Nr. articol: 216-123
Ferrule; Sleeve for 1 mm² / AWG 18; uninsulated; electro-tin plated

www.wago.com/216-123



Nr. articol: 216-124
Ferrule; Sleeve for 1.5 mm² / AWG 16; uninsulated; electro-tin plated

















www.wago.com/216-124



Nr. articol: 216-131
Ferrule; Sleeve for 0.25 mm² / AWG 24; uninsulated; electro-tin plated

www.wago.com/216-131

Supus modificărilor.

	Nr. articol: 216-132 Ferrule; Sleeve for 0.34 mm ² / AWG 24; uninsulated; electro-tin plated	www.wago.com/216-132
	Nr. articol: 216-151 Ferrule; Sleeve for 0.25 mm ² / AWG 24; uninsulated; electro-tin plated	www.wago.com/216-151
	Nr. articol: 216-152 Ferrule; Sleeve for 0.34 mm ² / AWG 24; uninsulated; electro-tin plated	www.wago.com/216-152
	Nr. articol: 216-201 Ferrule; Sleeve for 0.5 mm ² / 20 AWG; insulated; electro-tin plated; white	www.wago.com/216-201
	Nr. articol: 216-202 Ferrule; Sleeve for 0.75 mm ² / 18 AWG; insulated; electro-tin plated; gray	www.wago.com/216-202
	Nr. articol: 216-203 Ferrule; Sleeve for 1 mm ² / AWG 18; insulated; electro-tin plated; red	www.wago.com/216-203
	Nr. articol: 216-204 Ferrule; Sleeve for 1.5 mm ² / AWG 16; insulated; electro-tin plated; black	www.wago.com/216-204
	Nr. articol: 216-205 Ferrule; Sleeve for 2.08 mm ² / AWG 14; insulated; electro-tin plated; yellow	www.wago.com/216-205
	Nr. articol: 216-206 Ferrule; Sleeve for 2.5 mm ² / AWG 14; insulated; electro-tin plated; blue	www.wago.com/216-206
	Nr. articol: 216-221 Ferrule; Sleeve for 0.5 mm ² / 20 AWG; insulated; electro-tin plated; white	www.wago.com/216-221
	Nr. articol: 216-222 Ferrule; Sleeve for 0.75 mm ² / 18 AWG; insulated; electro-tin plated; gray	www.wago.com/216-222
	Nr. articol: 216-223 Ferrule; Sleeve for 1 mm ² / AWG 18; insulated; electro-tin plated; red	www.wago.com/216-223
	Nr. articol: 216-224 Ferrule; Sleeve for 1.5 mm ² / AWG 16; insulated; electro-tin plated; black	www.wago.com/216-224
	Nr. articol: 216-301 Ferrule; Sleeve for 0.25 mm ² / AWG 24; insulated; electro-tin plated; yellow	www.wago.com/216-301
	Nr. articol: 216-302 Ferrule; Sleeve for 0.34 mm ² / 22 AWG; insulated; electro-tin plated; green	www.wago.com/216-302
	Nr. articol: 216-321 Ferrule; Sleeve for 0.25 mm ² / AWG 24; insulated; electro-tin plated; yellow	www.wago.com/216-321
	Nr. articol: 216-322 Ferrule; Sleeve for 0.34 mm ² / 22 AWG; insulated; electro-tin plated; green	www.wago.com/216-322
check		
	Nr. articol: 210-136 Test plug; 2 mm Ø; with 500 mm cable; red	www.wago.com/210-136

Supus modificărilor.



Jumper



Nr. articol: 261-402

Comb-style jumper bar; insulated; 2-way; reduces conductor size to 1.5 mm; gray

www.wago.com/261-402

assembling



Nr. articol: 209-123

Mounting foot with screw; can be screwed on terminal blocks with fixing flange; 6.4 mm wide; gray

www.wago.com/209-123



Nr. articol: 209-137

Mounting adapter; can be used as end plate; 6.5 mm wide; gray

www.wago.com/209-137

tools



Nr. articol: 209-132

Operating tool; for connecting comb-style jumper bar; 2-way; of insulating material

www.wago.com/209-132



Nr. articol: 210-657

Operating tool; Blade: 3.5 x 0.5 mm; with a partially insulated shaft; short

www.wago.com/210-657



Nr. articol: 210-658

Operating tool; Blade: 3.5 x 0.5 mm; with a partially insulated shaft; angled; short

www.wago.com/210-658



Nr. articol: 210-720

Operating tool; Blade: 3.5 x 0.5 mm; with a partially insulated shaft

www.wago.com/210-720

Descărcări

Documentation

Additional Information

Technical explanations	Apr 3, 2019	pdf 2,1 MB	Descărcare
------------------------	-------------	---------------	------------

CAD/CAE-Data

CAD data

2D/3D Models 261-423/331-000	URL	Descărcare
------------------------------	-----	------------

CAE data

EPLAN Data Portal 261-423/331-000	URL	Descărcare
-----------------------------------	-----	------------

WSCAD Universe 261-423/331-000	URL	Descărcare
--------------------------------	-----	------------

Supus modificărilor.

WAGO Kontakttechnik GmbH & Co. KG
/Representative Office Romania
Sos. Pipera-Tunari nr. 1/1
building 1, 2nd floor | 077190 Voluntari, Ilfov
Tel.: +40-(0)31 421 85 68 | Email: info-RO@wago.com

Aveți întrebări despre produsele noastre?
Vă stăm la dispoziție pentru preluarea apelului la +40 (0) 31 421 85 68.

Installation Notes

Conductor termination

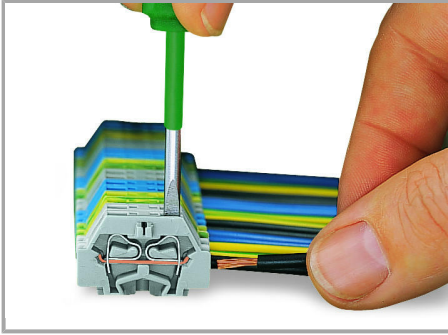

CAGE CLAMP® connection

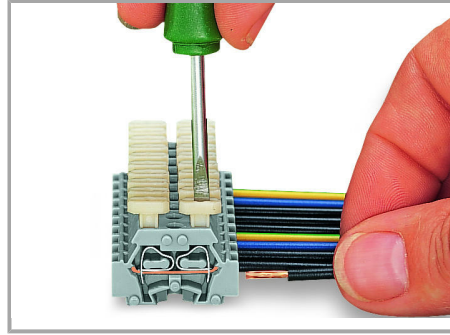

CAGE CLAMP® connection

Inserting a conductor.

Inserting a conductor via push-button.

With ferruled conductors, it is necessary to use a terminal block one size larger than the conductor's nominal cross-section.

Commoning

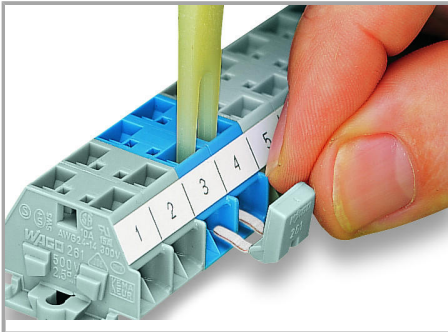

Commoning with comb-style jumper bar.

Testing

Supus modificărilor.

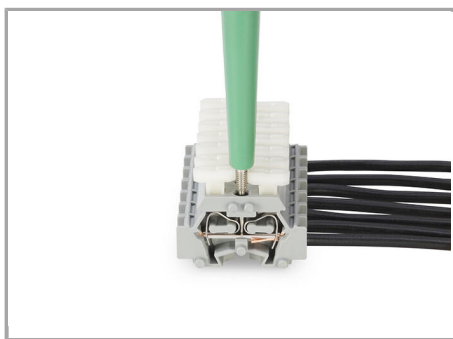

Testing with voltage tester.

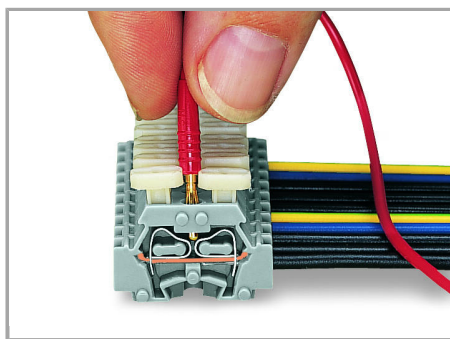

Testing with a 2 mm Ø test plug – touch contact.

Installation

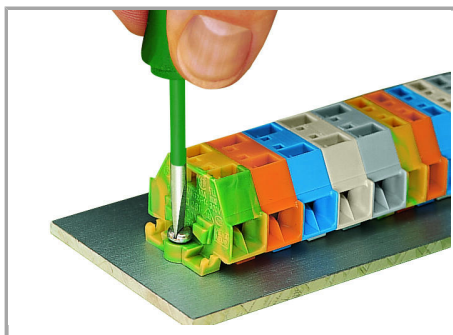

Mounting and securing a terminal strip directly to the plate via screw-type flanges.

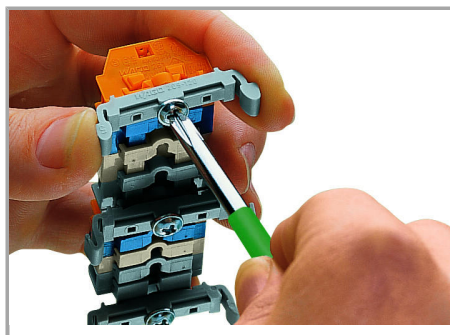

Terminal strip with mounting flanges – screwing a 209-123 Mounting Foot

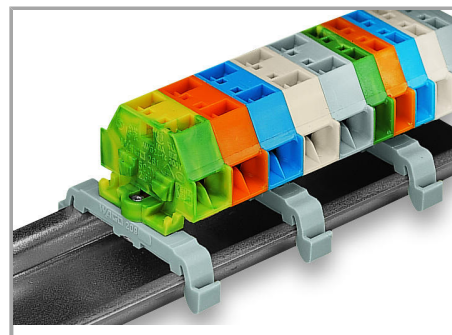

Terminal strip with mounting flanges on DIN-35 rail

(distance between mounting feet: approx. 25 ... 30 mm)

Marking

Supus modificărilor.

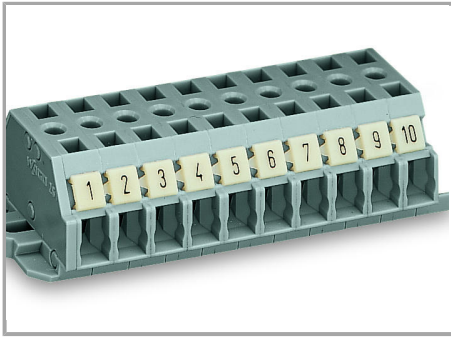

Terminal strip with marker slot for Mini-WSB
Quick Marking System

Supus modificărilor.

WAGO Kontakttechnik GmbH & Co. KG
/Representative Office Romania
Sos. Pipera-Tunari nr. 1/1
building 1, 2nd floor | 077190 Voluntari, Ilfov
Tel.: +40-(0)31 421 85 68 | Email: info-RO@wago.com

Aveți întrebări despre produsele noastre?
Vă stăm la dispoziție pentru preluarea apelului la +40 (0) 31 421 85 68.