

## Fișă tehnică | Număr articol: 261-422/331-000

2-conductor terminal strip; 2-pole; on one side with push-buttons; with fixing flanges; for screw or similar mounting types; Fixing hole 3.2 mm Ø; 2.5 mm<sup>2</sup>; CAGE CLAMP®; 2,50 mm<sup>2</sup>; gray

[www.wago.com/261-422/331-000](http://www.wago.com/261-422/331-000)

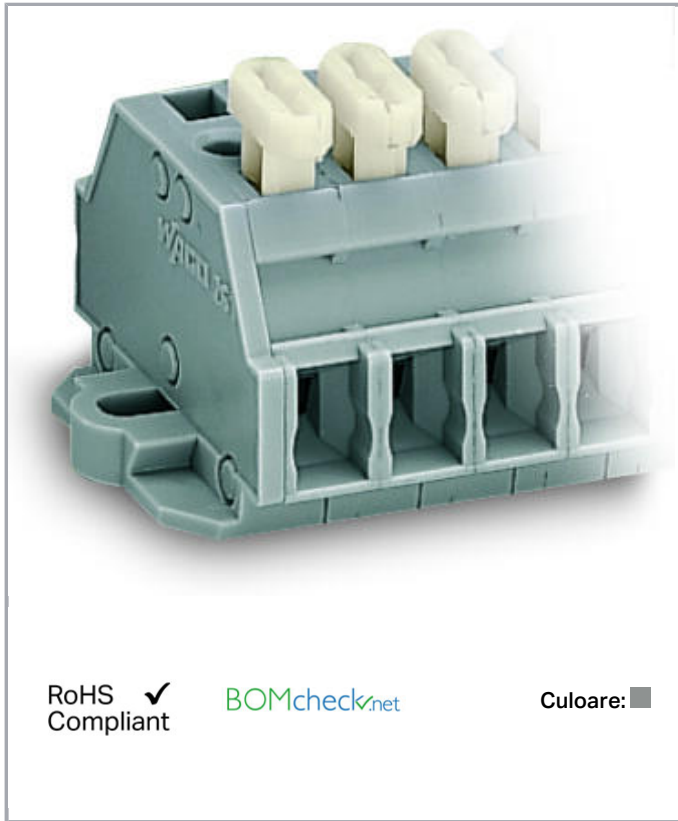

RoHS  Compliant

BOMcheck.net

Culoare: ■

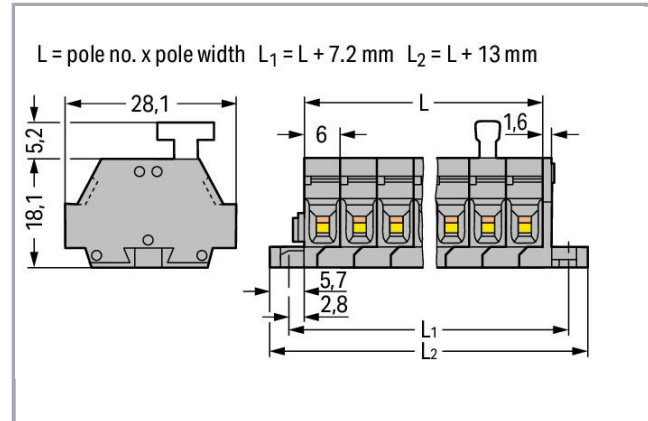

### Date

### Electrical data

### Ratings per IEC/EN 60664-1

|                             |   |
|-----------------------------|---|
| Nominal voltage (III/3)     | 500 V   |
| Rated surge voltage (III/3) | 6 kV  |
| Rated current               | 24 A  |
| Legend (ratings)            | (III / 3) ≙ Overvoltage category III / Pollution degree 3 |

### Connection data

|                       |                |
|-----------------------|----------------|
| Connection technology | CAGE CLAMP®    |
| Actuation type        | Operating tool |

Supus modificărilor.

WAGO Kontakttechnik GmbH & Co. KG  
/Representative Office Romania  
Sos. Pipera-Tunari nr. 1/1  
building 1, 2nd floor | 077190 Voluntari, Ilfov  
Tel.: +40-(0)31 421 85 68 | Email: info-RO@wago.com

Aveți întrebări despre produsele noastre?  
Vă stăm la dispoziție pentru preluarea apelului la +40 (0) 31 421 85 68.



|                                   |  |
|-----------------------------------|--|
|                                   | Push-button                                  |
| Connectable conductor materials   | Copper                                       |
| Solid conductor                   | 0.08 ... 2.5 mm <sup>2</sup> / 28 ... 14 AWG |
| Fine-stranded conductor           | 0.08 ... 2.5 mm <sup>2</sup> / 28 ... 14 AWG |
| Strip length                      | 8 ... 9 mm / 0.31 ... 0.35 inch              |
| Pole No.                          | 2  |
| Total number of connection points | 4  |
| Total number of potentials        | 2  |
| Number of levels                  | 1  |
| Wiring type                       | Side-entry wiring                            |

**Geometrical Data**

|                         |                      |
|-------------------------|----------------------|
| Width                   | 25.6 mm / 1.008 inch |
| Height from the surface | 23.2 mm / 0.913 inch |
| Depth                   | 28 mm / 1.102 inch   |
| Module width            | 6 mm / 0.236 inch    |

**Mechanical data**

|               |                 |
|---------------|-----------------|
| Design        | horizontal      |
| Mounting type | Mounting flange |
| Marking level | Side marking    |

**Material Data**

|           |          |
|-----------|----------|
| Color     | gray     |
| Fire load | 0,128 MJ |
| Weight    | 6,1 g    |

**Commercial data**

|                       |               |
|-----------------------|---------------|
| Packaging type        | BOX           |
| Country of origin     | DE            |
| GTIN                  | 4044918626774 |
| Customs tariff number | 85369010000   |

**Counterpart**







Supus modificărilor.

WAGO Kontakttechnik GmbH & Co. KG  
 /Representative Office Romania  
 Sos. Pipera-Tunari nr. 1/1  
 building 1, 2nd floor | 077190 Voluntari, Ilfov  
 Tel.: +40-(0)31 421 85 68 | Email: info-RO@wago.com

Aveți întrebări despre produsele noastre?  
 Vă stăm la dispoziție pentru preluarea apelului la +40 (0) 31 421 85 68.

## Produse compatibile

### Marking accessories

|  |  |  |
|--|--|--|
|    | <b>Nr. articol: 2009-145</b><br>Mini-WSB Inline; for Smart Printer; 1700 pieces on roll; stretchable 5 - 5.2 mm; plain; snap-on type; white          | <a href="http://www.wago.com/2009-145">www.wago.com/2009-145</a>                 |
|    | <b>Nr. articol: 2009-145/000-002</b><br>Mini-WSB Inline; for Smart Printer; 1700 pieces on roll; stretchable 5 - 5.2 mm; plain; snap-on type; yellow | <a href="http://www.wago.com/2009-145/000-002">www.wago.com/2009-145/000-002</a> |
|    | <b>Nr. articol: 2009-145/000-005</b><br>Mini-WSB Inline; for Smart Printer; 1700 pieces on roll; stretchable 5 - 5.2 mm; plain; snap-on type; red    | <a href="http://www.wago.com/2009-145/000-005">www.wago.com/2009-145/000-005</a> |
|    | <b>Nr. articol: 2009-145/000-006</b><br>Mini-WSB Inline; for Smart Printer; 1700 pieces on roll; stretchable 5 - 5.2 mm; plain; snap-on type; blue   | <a href="http://www.wago.com/2009-145/000-006">www.wago.com/2009-145/000-006</a> |
|   | <b>Nr. articol: 2009-145/000-007</b><br>Mini-WSB Inline; for Smart Printer; 1700 pieces on roll; stretchable 5 - 5.2 mm; plain; snap-on type; grey   | <a href="http://www.wago.com/2009-145/000-007">www.wago.com/2009-145/000-007</a> |
|  | <b>Nr. articol: 2009-145/000-012</b><br>Mini-WSB Inline; for Smart Printer; 1700 pieces on roll; stretchable 5 - 5.2 mm; plain; snap-on type; orange | <a href="http://www.wago.com/2009-145/000-012">www.wago.com/2009-145/000-012</a> |
|  | <b>Nr. articol: 2009-145/000-023</b><br>Mini-WSB Inline; for Smart Printer; 1700 pieces on roll; stretchable 5 - 5.2 mm; plain; snap-on type; green  | <a href="http://www.wago.com/2009-145/000-023">www.wago.com/2009-145/000-023</a> |
|  | <b>Nr. articol: 2009-145/000-024</b><br>Mini-WSB Inline; for Smart Printer; 1700 pieces on roll; stretchable 5 - 5.2 mm; plain; snap-on type; violet | <a href="http://www.wago.com/2009-145/000-024">www.wago.com/2009-145/000-024</a> |
|  | <b>Nr. articol: 248-501</b><br>Miniature WSB Quick marking system; plain; Marker width 5 mm; 10 strips with 10 markers per card                      | <a href="http://www.wago.com/248-501">www.wago.com/248-501</a>                   |
|  | <b>Nr. articol: 248-501/000-002</b><br>Mini-WSB marking card; as card; not stretchable; plain; snap-on type; yellow                                  | <a href="http://www.wago.com/248-501/000-002">www.wago.com/248-501/000-002</a>   |
|  | <b>Nr. articol: 248-501/000-005</b><br>Mini-WSB marking card; as card; not stretchable; plain; snap-on type; red                                     | <a href="http://www.wago.com/248-501/000-005">www.wago.com/248-501/000-005</a>   |

Supus modificărilor.



**Nr. articol: 248-501/000-006**  
Mini-WSB marking card; as card; not stretchable; plain; snap-on type; blue

[www.wago.com/248-501/000-006](http://www.wago.com/248-501/000-006)



**Nr. articol: 248-501/000-007**  
Mini-WSB marking card; as card; not stretchable; plain; snap-on type; gray

[www.wago.com/248-501/000-007](http://www.wago.com/248-501/000-007)



**Nr. articol: 248-501/000-012**  
Mini-WSB marking card; as card; not stretchable; plain; snap-on type; orange

[www.wago.com/248-501/000-012](http://www.wago.com/248-501/000-012)



**Nr. articol: 248-501/000-017**  
Mini-WSB marking card; as card; not stretchable; plain; snap-on type; light green

[www.wago.com/248-501/000-017](http://www.wago.com/248-501/000-017)



**Nr. articol: 248-501/000-023**  
Mini-WSB marking card; as card; not stretchable; plain; snap-on type; green

[www.wago.com/248-501/000-023](http://www.wago.com/248-501/000-023)



**Nr. articol: 248-501/000-024**  
Mini-WSB marking card; as card; not stretchable; plain; snap-on type; violet

[www.wago.com/248-501/000-024](http://www.wago.com/248-501/000-024)

#### tools



**Nr. articol: 209-132**  
Operating tool; for connecting comb-style jumper bar; 2-way; of insulating material

[www.wago.com/209-132](http://www.wago.com/209-132)



**Nr. articol: 210-657**  
Operating tool; Blade: 3.5 x 0.5 mm; with a partially insulated shaft; short

[www.wago.com/210-657](http://www.wago.com/210-657)



**Nr. articol: 210-658**  
Operating tool; Blade: 3.5 x 0.5 mm; with a partially insulated shaft; angled; short

[www.wago.com/210-658](http://www.wago.com/210-658)



**Nr. articol: 210-720**  
Operating tool; Blade: 3.5 x 0.5 mm; with a partially insulated shaft

[www.wago.com/210-720](http://www.wago.com/210-720)

#### assembling



**Nr. articol: 209-123**  
Mounting foot with screw; can be screwed on terminal blocks with fixing flange; 6.4 mm wide; gray

[www.wago.com/209-123](http://www.wago.com/209-123)

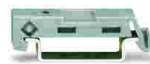

**Nr. articol: 209-137**  
Mounting adapter; can be used as end plate; 6.5 mm wide; gray

[www.wago.com/209-137](http://www.wago.com/209-137)

#### Jumper



**Nr. articol: 261-402**  
Comb-style jumper bar; insulated; 2-way; reduces conductor size to 1.5 mm; gray

[www.wago.com/261-402](http://www.wago.com/261-402)

#### check





















**Nr. articol: 210-136**  
Test plug; 2 mm Ø; with 500 mm cable; red

[www.wago.com/210-136](http://www.wago.com/210-136)

#### ferrule



Supus modificărilor.

|  |   |  |
|--|---|--|
|    | <b>Nr. articol: 216-101</b><br>Ferrule; Sleeve for 0.5 mm <sup>2</sup> / AWG 22; uninsulated; electro-tin plated        | <a href="http://www.wago.com/216-101">www.wago.com/216-101</a> |
|    | <b>Nr. articol: 216-102</b><br>Ferrule; Sleeve for 0.75 mm <sup>2</sup> / AWG 20; uninsulated; electro-tin plated       | <a href="http://www.wago.com/216-102">www.wago.com/216-102</a> |
|    | <b>Nr. articol: 216-103</b><br>Ferrule; Sleeve for 1 mm <sup>2</sup> / AWG 18; uninsulated; electro-tin plated          | <a href="http://www.wago.com/216-103">www.wago.com/216-103</a> |
|    | <b>Nr. articol: 216-104</b><br>Ferrule; Sleeve for 1.5 mm <sup>2</sup> / AWG 16; uninsulated; electro-tin plated        | <a href="http://www.wago.com/216-104">www.wago.com/216-104</a> |
|    | <b>Nr. articol: 216-106</b><br>Ferrule; Sleeve for 2.5 mm <sup>2</sup> / AWG 14; uninsulated; electro-tin plated        | <a href="http://www.wago.com/216-106">www.wago.com/216-106</a> |
|    | <b>Nr. articol: 216-121</b><br>Ferrule; Sleeve for 0.5 mm <sup>2</sup> / AWG 22; uninsulated; electro-tin plated        | <a href="http://www.wago.com/216-121">www.wago.com/216-121</a> |
|    | <b>Nr. articol: 216-122</b><br>Ferrule; Sleeve for 0.75 mm <sup>2</sup> / AWG 20; uninsulated; electro-tin plated       | <a href="http://www.wago.com/216-122">www.wago.com/216-122</a> |
|    | <b>Nr. articol: 216-123</b><br>Ferrule; Sleeve for 1 mm <sup>2</sup> / AWG 18; uninsulated; electro-tin plated          | <a href="http://www.wago.com/216-123">www.wago.com/216-123</a> |
|    | <b>Nr. articol: 216-124</b><br>Ferrule; Sleeve for 1.5 mm <sup>2</sup> / AWG 16; uninsulated; electro-tin plated        | <a href="http://www.wago.com/216-124">www.wago.com/216-124</a> |
|   | <b>Nr. articol: 216-131</b><br>Ferrule; Sleeve for 0.25 mm <sup>2</sup> / AWG 24; uninsulated; electro-tin plated       | <a href="http://www.wago.com/216-131">www.wago.com/216-131</a> |
|  | <b>Nr. articol: 216-132</b><br>Ferrule; Sleeve for 0.34 mm <sup>2</sup> / AWG 24; uninsulated; electro-tin plated       | <a href="http://www.wago.com/216-132">www.wago.com/216-132</a> |
|  | <b>Nr. articol: 216-151</b><br>Ferrule; Sleeve for 0.25 mm <sup>2</sup> / AWG 24; uninsulated; electro-tin plated       | <a href="http://www.wago.com/216-151">www.wago.com/216-151</a> |
|  | <b>Nr. articol: 216-152</b><br>Ferrule; Sleeve for 0.34 mm <sup>2</sup> / AWG 24; uninsulated; electro-tin plated       | <a href="http://www.wago.com/216-152">www.wago.com/216-152</a> |
|  | <b>Nr. articol: 216-201</b><br>Ferrule; Sleeve for 0.5 mm <sup>2</sup> / 20 AWG; insulated; electro-tin plated; white   | <a href="http://www.wago.com/216-201">www.wago.com/216-201</a> |
|  | <b>Nr. articol: 216-202</b><br>Ferrule; Sleeve for 0.75 mm <sup>2</sup> / 18 AWG; insulated; electro-tin plated; gray   | <a href="http://www.wago.com/216-202">www.wago.com/216-202</a> |
|  | <b>Nr. articol: 216-203</b><br>Ferrule; Sleeve for 1 mm <sup>2</sup> / AWG 18; insulated; electro-tin plated; red       | <a href="http://www.wago.com/216-203">www.wago.com/216-203</a> |
|  | <b>Nr. articol: 216-204</b><br>Ferrule; Sleeve for 1.5 mm <sup>2</sup> / AWG 16; insulated; electro-tin plated; black   | <a href="http://www.wago.com/216-204">www.wago.com/216-204</a> |
|  | <b>Nr. articol: 216-205</b><br>Ferrule; Sleeve for 2.08 mm <sup>2</sup> / AWG 14; insulated; electro-tin plated; yellow | <a href="http://www.wago.com/216-205">www.wago.com/216-205</a> |

Supus modificărilor.

WAGO Kontakttechnik GmbH & Co. KG  
/Representative Office Romania  
Sos. Pipera-Tunari nr. 1/1  
building 1, 2nd floor | 077190 Voluntari, Ilfov  
Tel.: +40-(0)31 421 85 68 | Email: info-RO@wago.com

Aveți întrebări despre produsele noastre?  
Vă stăm la dispoziție pentru preluarea apelului la +40 (0) 31 421 85 68.

|   |   |  |
|---|---|--|
|  | <b>Nr. articol: 216-206</b><br>Ferrule; Sleeve for 2.5 mm <sup>2</sup> / AWG 14; insulated; electro-tin plated; blue    | <a href="http://www.wago.com/216-206">www.wago.com/216-206</a> |
|  | <b>Nr. articol: 216-221</b><br>Ferrule; Sleeve for 0.5 mm <sup>2</sup> / 20 AWG; insulated; electro-tin plated; white   | <a href="http://www.wago.com/216-221">www.wago.com/216-221</a> |
|  | <b>Nr. articol: 216-222</b><br>Ferrule; Sleeve for 0.75 mm <sup>2</sup> / 18 AWG; insulated; electro-tin plated; gray   | <a href="http://www.wago.com/216-222">www.wago.com/216-222</a> |
|  | <b>Nr. articol: 216-223</b><br>Ferrule; Sleeve for 1 mm <sup>2</sup> / AWG 18; insulated; electro-tin plated; red       | <a href="http://www.wago.com/216-223">www.wago.com/216-223</a> |
|  | <b>Nr. articol: 216-224</b><br>Ferrule; Sleeve for 1.5 mm <sup>2</sup> / AWG 16; insulated; electro-tin plated; black   | <a href="http://www.wago.com/216-224">www.wago.com/216-224</a> |
|   | <b>Nr. articol: 216-301</b><br>Ferrule; Sleeve for 0.25 mm <sup>2</sup> / AWG 24; insulated; electro-tin plated; yellow | <a href="http://www.wago.com/216-301">www.wago.com/216-301</a> |
|  | <b>Nr. articol: 216-302</b><br>Ferrule; Sleeve for 0.34 mm <sup>2</sup> / 22 AWG; insulated; electro-tin plated; green  | <a href="http://www.wago.com/216-302">www.wago.com/216-302</a> |
|   | <b>Nr. articol: 216-321</b><br>Ferrule; Sleeve for 0.25 mm <sup>2</sup> / AWG 24; insulated; electro-tin plated; yellow | <a href="http://www.wago.com/216-321">www.wago.com/216-321</a> |
|  | <b>Nr. articol: 216-322</b><br>Ferrule; Sleeve for 0.34 mm <sup>2</sup> / 22 AWG; insulated; electro-tin plated; green  | <a href="http://www.wago.com/216-322">www.wago.com/216-322</a> |

## Descărcări

### Documentation

#### Additional Information

|                        |             |               |            |
|------------------------|-------------|---------------|------------|
| Technical explanations | Apr 3, 2019 | pdf<br>2,1 MB | Descărcare |
|------------------------|-------------|---------------|------------|

### CAD/CAE-Data

#### CAD data

|                              |     |            |
|------------------------------|-----|------------|
| 2D/3D Models 261-422/331-000 | URL | Descărcare |
|------------------------------|-----|------------|

#### CAE data

|                                   |     |            |
|-----------------------------------|-----|------------|
| EPLAN Data Portal 261-422/331-000 | URL | Descărcare |
|-----------------------------------|-----|------------|

|                                |     |            |
|--------------------------------|-----|------------|
| WSCAD Universe 261-422/331-000 | URL | Descărcare |
|--------------------------------|-----|------------|

Supus modificărilor.

WAGO Kontakttechnik GmbH & Co. KG  
/Representative Office Romania  
Sos. Pipera-Tunari nr. 1/1  
building 1, 2nd floor | 077190 Voluntari, Ilfov  
Tel.: +40-(0)31 421 85 68 | Email: info-RO@wago.com

Aveți întrebări despre produsele noastre?  
Vă stăm la dispoziție pentru preluarea apelului la +40 (0) 31 421 85 68.

## Installation Notes

### Conductor termination

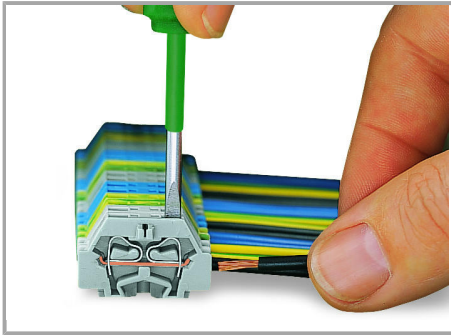

CAGE CLAMP® connection

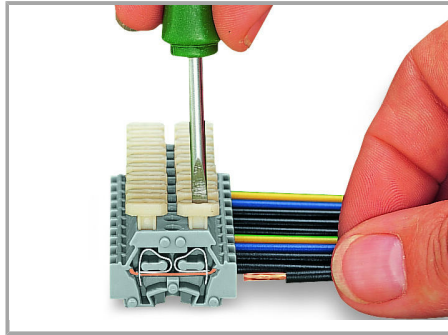

CAGE CLAMP® connection

Inserting a conductor.

Inserting a conductor via push-button.

With ferruled conductors, it is necessary to use a terminal block one size larger than the conductor's nominal cross-section.

### Commoning

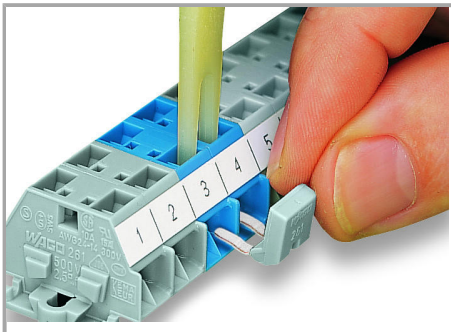

Commoning with comb-style jumper bar.

### Testing

Supus modificărilor.



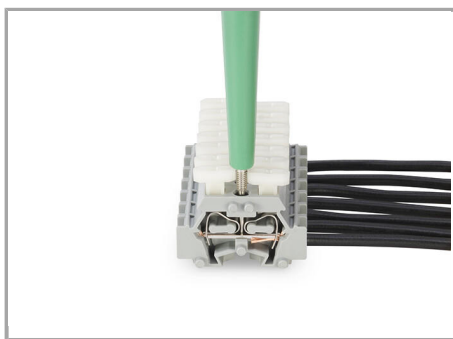

Testing with voltage tester.

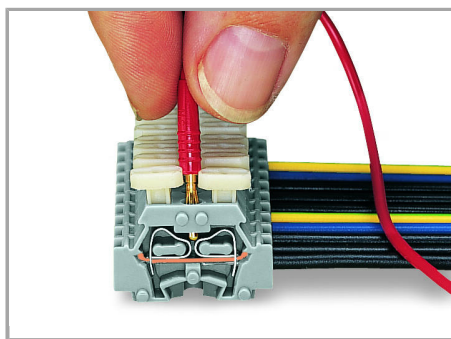

Testing with a 2 mm Ø test plug – touch contact.

### Installation

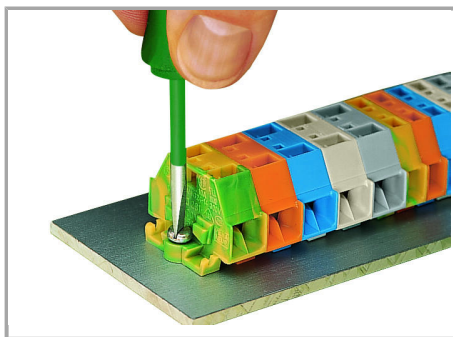

Mounting and securing a terminal strip directly to the plate via screw-type flanges.

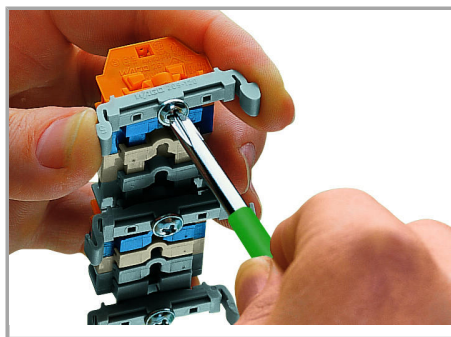

Terminal strip with mounting flanges – screwing a 209-123 Mounting Foot

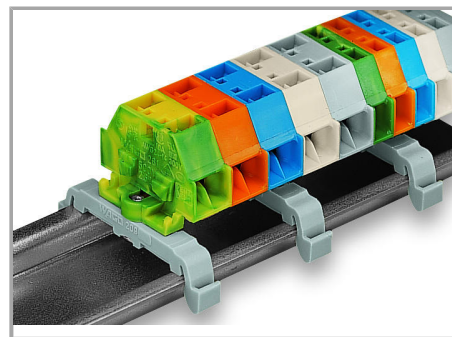

Terminal strip with mounting flanges on DIN-35 rail

(distance between mounting feet: approx. 25 ... 30 mm)

### Marking

Supus modificărilor.



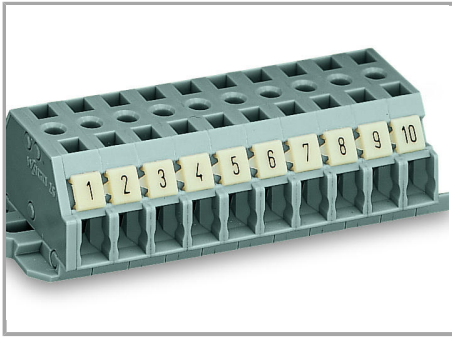

Terminal strip with marker slot for Mini-WSB  
Quick Marking System

Supus modificărilor.