

Fișă tehnică | Număr articol: 805-358

PCB terminal block; push-button; 1.5 mm²; Pin spacing 3.5 mm; 8-pole; Push-in CAGE CLAMP®; 1,50 mm²; gray

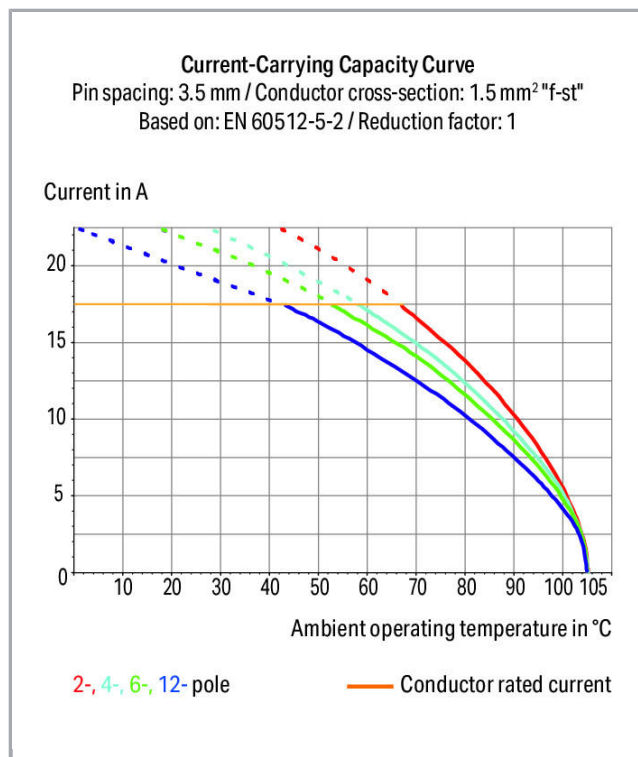

www.wago.com/805-358



Supus modificărilor.

WAGO Kontakttechnik GmbH & Co. KG
/Representative Office Romania
Sos. Pipera-Tunari nr. 1/1
building 1, 2nd floor | 077190 Voluntari, Ilfov
Tel.: +40-(0)31 421 85 68 | Email: info-RO@wago.com

Aveți întrebări despre produsele noastre?
Vă stăm la dispoziție pentru preluarea apelului la +40 (0) 31 421 85 68.

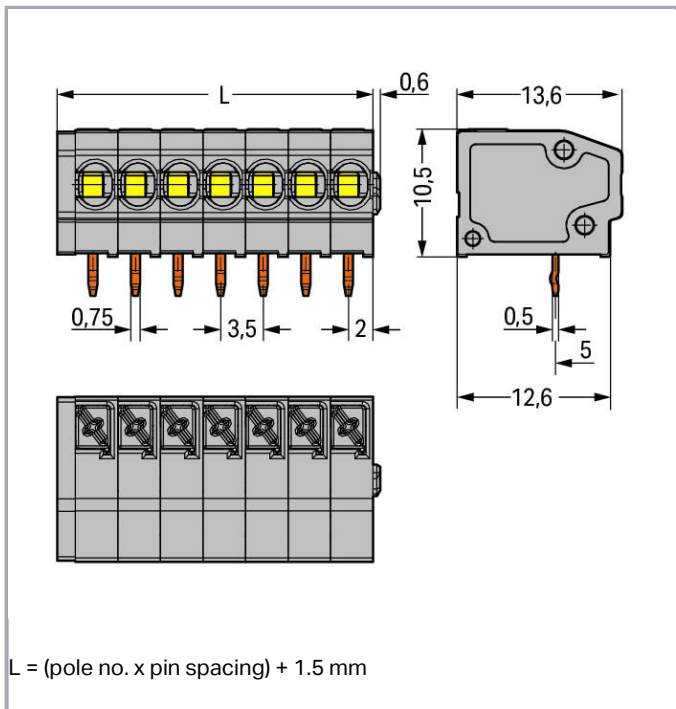

Descriere articol

- PCB terminal strips with push-buttons and Push-in CAGE CLAMP® connection
- Push-in termination of solid and ferruled conductors
- Flush-mount push-buttons that close with minimal force for convenient termination/removal of fine-stranded conductors
- Convenient, tool-free operation
- Versions with/without test slots and spacers
- Versions available with custom internal commoning (factory assembly), e.g., commoning ground conductor

Date

Electrical data

Ratings per IEC/EN 60664-1

Ratings per	IEC/EN 60664-1
Nominal voltage (III/3)	160 V
Rated surge voltage (III/3)	2,5 kV
Rated voltage (III/2)	160 V
Rated surge voltage (III/2)	2,5 kV
Nominal voltage (II/2)	320 V

Supus modificărilor.

WAGO Kontakttechnik GmbH & Co. KG
 /Representative Office Romania
 Sos. Pipera-Tunari nr. 1/1
 building 1, 2nd floor | 077190 Voluntari, Ilfov
 Tel.: +40-(0)31 421 85 68 | Email: info-RO@wago.com

Aveți întrebări despre produsele noastre?
 Vă stăm la dispoziție pentru preluarea apelului la +40 (0) 31 421 85 68.



Rated surge voltage (II/2)	2,5 kV
Rated current	17,5 A
Legend (ratings)	(III / 2) $\hat{=}$ Overvoltage category III / Pollution degree 2

Approvals per UL 1059

Rated voltage UL (Use Group B)	300 V
Rated current UL (Use Group B)	10 A
Rated voltage UL (Use Group C)	150 V
Rated current UL (Use Group C)	10 A
Rated voltage UL (Use Group D)	300 V
Rated current UL (Use Group D)	10 A
Approvals per	UL 1059

Connection data

Connection technology	Push-in CAGE CLAMP [®]
Actuation type	Push-button
Solid conductor	0.2 ... 1.5 mm ² / 24 ... 16 AWG
Fine-stranded conductor	0.2 ... 1.5 mm ² / 24 ... 16 AWG
Fine-stranded conductor; with insulated ferrule	0.25 ... 1 mm ²
Fine-stranded conductor; with uninsulated ferrule	0.25 ... 1 mm ²
Strip length	9 ... 10 mm / 0.35 ... 0.39 inch
Conductor connection direction to PCB	0°
Pole No.	8
Total number of connection points	8
Total number of potentials	8
Number of connection types	1
Number of levels	1

Geometrical Data

Pin spacing	3.5 mm / 0.138 inch
Width	29.5 mm / 1.161 inch
Height	13.7 mm / 0.539 inch
Height from the surface	10.5 mm / 0.413 inch
Depth	13.6 mm / 0.535 inch
Solder pin length	3,2 mm
Solder pin dimensions	0.5 x 0.75 mm

Supus modificărilor.

WAGO Kontakttechnik GmbH & Co. KG
 /Representative Office Romania
 Sos. Pipera-Tunari nr. 1/1
 building 1, 2nd floor | 077190 Voluntari, Ilfov
 Tel.: +40-(0)31 421 85 68 | Email: info-RO@wago.com

Aveți întrebări despre produsele noastre?
 Vă stăm la dispoziție pentru preluarea apelului la +40 (0) 31 421 85 68.

Drilled hole diameter with tolerance	1.1 (+0.1) mm
--------------------------------------	---------------

PCB contact

PCB contact	THT
Solder pin arrangement	over the entire terminal strip, in line
Number of solder pins per potential	1

Material Data

Color	gray
Material group	I
Insulation material	Polyamide 66 (PA 66)
Flammability class per UL94	V0
Clamping spring material	Chrome nickel spring steel (CrNi)
Contact material	Electrolytic copper (E _{Cu})
Contact plating	tin-plated
Weight	2 g

Environmental Requirements

Limit temperature range	-60 ... +105 °C
-------------------------	-----------------

Commercial data

Packaging type	BOX
Country of origin	PL
GTIN	4055143388610
Customs tariff number	85369010000

Aprobări / certificate

UL-Approvals

Embleă	Aprobare	Text de aprobare suplimentar	Nume certificat
	UR Underwriters Laboratories Inc.	UL 1059	E45172, sec. 6

Supus modificărilor.

Counterpart

Produse compatibile

tools

**Nr. articol: 210-647**

Operating tool; Blade: 2.5 x 0.4 mm; with a partially insulated shaft

www.wago.com/210-647**Nr. articol: 210-719**















Operating tool; Blade: 2.5 x 0.4 mm; with a partially insulated shaft

www.wago.com/210-719

ferrule

**Nr. articol: 216-101**Ferrule; Sleeve for 0.5 mm² / AWG 22; uninsulated; electro-tin platedwww.wago.com/216-101**Nr. articol: 216-102**Ferrule; Sleeve for 0.75 mm² / AWG 20; uninsulated; electro-tin platedwww.wago.com/216-102**Nr. articol: 216-103**Ferrule; Sleeve for 1 mm² / AWG 18; uninsulated; electro-tin platedwww.wago.com/216-103**Nr. articol: 216-121**Ferrule; Sleeve for 0.5 mm² / AWG 22; uninsulated; electro-tin platedwww.wago.com/216-121**Nr. articol: 216-122**Ferrule; Sleeve for 0.75 mm² / AWG 20; uninsulated; electro-tin platedwww.wago.com/216-122**Nr. articol: 216-123**Ferrule; Sleeve for 1 mm² / AWG 18; uninsulated; electro-tin platedwww.wago.com/216-123**Nr. articol: 216-131**Ferrule; Sleeve for 0.25 mm² / AWG 24; uninsulated; electro-tin platedwww.wago.com/216-131**Nr. articol: 216-132**Ferrule; Sleeve for 0.34 mm² / AWG 24; uninsulated; electro-tin platedwww.wago.com/216-132**Nr. articol: 216-141**Ferrule; Sleeve for 0.5 mm² / 20 AWG; uninsulated; electro-tin plated; electrolytic copper; gastight crimped; acc. to DIN 46228, Part 1/08.92www.wago.com/216-141**Nr. articol: 216-142**Ferrule; Sleeve for 0.75 mm² / 18 AWG; uninsulated; electro-tin plated; electrolytic copper; gastight crimped; acc. to DIN 46228, Part 1/08.92www.wago.com/216-142**Nr. articol: 216-143**Ferrule; Sleeve for 1 mm² / AWG 18; uninsulated; electro-tin plated; electrolytic copper; gastight crimped; acc. to DIN 46228, Part 1/08.92www.wago.com/216-143**Nr. articol: 216-151**Ferrule; Sleeve for 0.25 mm² / AWG 24; uninsulated; electro-tin platedwww.wago.com/216-151

Supus modificărilor.

	Nr. articol: 216-152 Ferrule; Sleeve for 0.34 mm ² / AWG 24; uninsulated; electro-tin plated	www.wago.com/216-152
	Nr. articol: 216-201 Ferrule; Sleeve for 0.5 mm ² / 20 AWG; insulated; electro-tin plated; white	www.wago.com/216-201
	Nr. articol: 216-202 Ferrule; Sleeve for 0.75 mm ² / 18 AWG; insulated; electro-tin plated; gray	www.wago.com/216-202
	Nr. articol: 216-203 Ferrule; Sleeve for 1 mm ² / AWG 18; insulated; electro-tin plated; red	www.wago.com/216-203
	Nr. articol: 216-221 Ferrule; Sleeve for 0.5 mm ² / 20 AWG; insulated; electro-tin plated; white	www.wago.com/216-221
	Nr. articol: 216-222 Ferrule; Sleeve for 0.75 mm ² / 18 AWG; insulated; electro-tin plated; gray	www.wago.com/216-222
	Nr. articol: 216-223 Ferrule; Sleeve for 1 mm ² / AWG 18; insulated; electro-tin plated; red	www.wago.com/216-223
	Nr. articol: 216-241 Ferrule; Sleeve for 0.5 mm ² / 20 AWG; insulated; electro-tin plated; electrolytic copper; gastight crimped; acc. to DIN 46228, Part 4/09.90; white	www.wago.com/216-241
	Nr. articol: 216-242 Ferrule; Sleeve for 0.75 mm ² / 18 AWG; insulated; electro-tin plated; electrolytic copper; gastight crimped; acc. to DIN 46228, Part 4/09.90; gray	www.wago.com/216-242
	Nr. articol: 216-243 Ferrule; Sleeve for 1 mm ² / AWG 18; insulated; electro-tin plated; electrolytic copper; gastight crimped; acc. to DIN 46228, Part 4/09.90; red	www.wago.com/216-243
	Nr. articol: 216-262 Ferrule; Sleeve for 0.75 mm ² / 18 AWG; insulated; electro-tin plated; electrolytic copper; gastight crimped; acc. to DIN 46228, Part 4/09.90; gray	www.wago.com/216-262
	Nr. articol: 216-263 Ferrule; Sleeve for 1 mm ² / AWG 18; insulated; electro-tin plated; electrolytic copper; gastight crimped; acc. to DIN 46228, Part 4/09.90; red	www.wago.com/216-263
	Nr. articol: 216-301 Ferrule; Sleeve for 0.25 mm ² / AWG 24; insulated; electro-tin plated; yellow	www.wago.com/216-301
	Nr. articol: 216-302 Ferrule; Sleeve for 0.34 mm ² / 22 AWG; insulated; electro-tin plated; green	www.wago.com/216-302
	Nr. articol: 216-321 Ferrule; Sleeve for 0.25 mm ² / AWG 24; insulated; electro-tin plated; yellow	www.wago.com/216-321
	Nr. articol: 216-322 Ferrule; Sleeve for 0.34 mm ² / 22 AWG; insulated; electro-tin plated; green	www.wago.com/216-322

Marking accessories

Nr. articol: 210-332/350-202 Marking strips; as a DIN A4 sheet; MARKED; 1-16 (240x); Height of marker strip: 3 mm; Strip length 182 mm; Horizontal marking; Self-adhesive; white	www.wago.com/210-332/350-202
--	--

Supus modificărilor.

**Nr. articol: 210-332/350-204**

Marking strips; as a DIN A4 sheet; MARKED; 17-32 (240x); Height of marker strip: 3 mm; Strip length 182 mm; Horizontal marking; Self-adhesive; white

www.wago.com/210-332/350-204**Nr. articol: 210-332/350-206**

Marking strips; as a DIN A4 sheet; MARKED; 33-48 (240x); Height of marker strip: 3 mm; Strip length 182 mm; Horizontal marking; Self-adhesive; white

www.wago.com/210-332/350-206**Descărcări****Documentation****Additional Information**

Technical explanations

Apr 3, 2019

pdf
3,6 MB

Descărcare

CAD/CAE-Data**CAD data**

2D/3D Models 805-358

URL

Descărcare

PCB Design

Symbol and Footprint 805-358

URL

Descărcare

CAX data for your PCB design, consisting of "schematic symbols and PCB footprints", allow easy integration of the WAGO component into your development environment.

Supported formats:

- Accel EDA 14 & 15
- Altium 6 to current version
- Cadence Allegro
- DesignSpark
- Eagle Libraries
- KiCad
- Mentor Graphics BoardStation
- Mentor Graphics Design Architect
- Mentor Graphics Design Expedition 99 and 2000
- OrCAD 9.X PCB and Capture
- PADS PowerPCB 3, 3.5, 4.X, and 5.X
- PADS PowerPCB and PowerLogic 3.0
- PCAD 2000, 2001, 2002, 2004, and 2006

Supus modificărilor.

WAGO Kontakttechnik GmbH & Co. KG
/Representative Office Romania
Sos. Pipera-Tunari nr. 1/1
building 1, 2nd floor | 077190 Voluntari, Ilfov
Tel.: +40-(0)31 421 85 68 | Email: info-RO@wago.com

Aveți întrebări despre produsele noastre?

Vă stăm la dispoziție pentru preluarea apelului la +40 (0) 31 421 85 68.

- Pulsonix 8.5 or newer
- STL
- 3D STEP
- TARGET 3001!
- View Logic ViewDraw
- Quadcept
- Zuken CadStar 3 and 4
- Zuken CR-5000 and CR-8000

PCB Component Libraries (EDA), PCB CAD Library Ultra Librarian

Installation Notes

Inserting a conductor

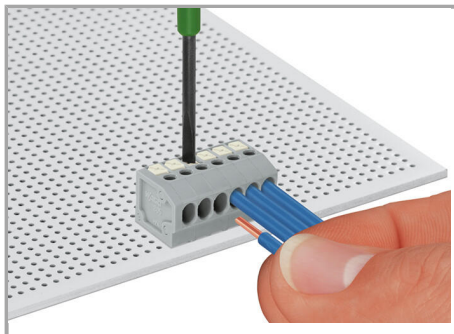

Terminating solid conductors by simply pushing them in. Removing conductors and inserting fine-stranded conductors via push-buttons.

Assembly

Supus modificărilor.



Terminal strips with spacers and enlarged conductor entry (5 mm pin spacing) are available upon request.

Jumpered

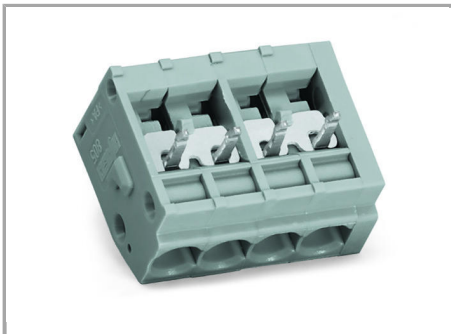

WAGO's 805 Series Terminal Strips provide "internal commoning" to meet requirements that ban routing the ground conductor over the board. This enables custom terminal strips to be commoned and marked at the factory upon request.

Assembly

Supus modificărilor.



Mixed-color terminal strips are available upon request.

Supus modificărilor.