

Fișă tehnică | Număr articol: 257-407/000-009/999-950

PCB terminal block; push-button; 2.5 mm²; Pin spacing 5/5.08 mm; 7-pole;
suitable for Ex-e applications; CAGE CLAMP®; commoning option; 2,50 mm²;
light gray

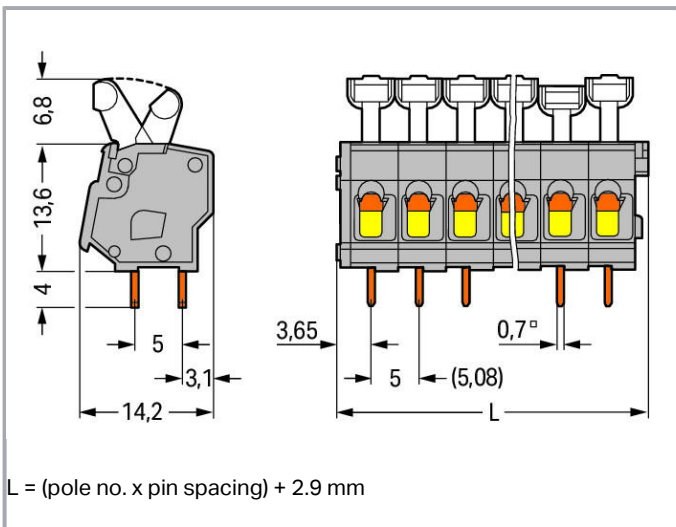

www.wago.com/257-407/000-009/999-950

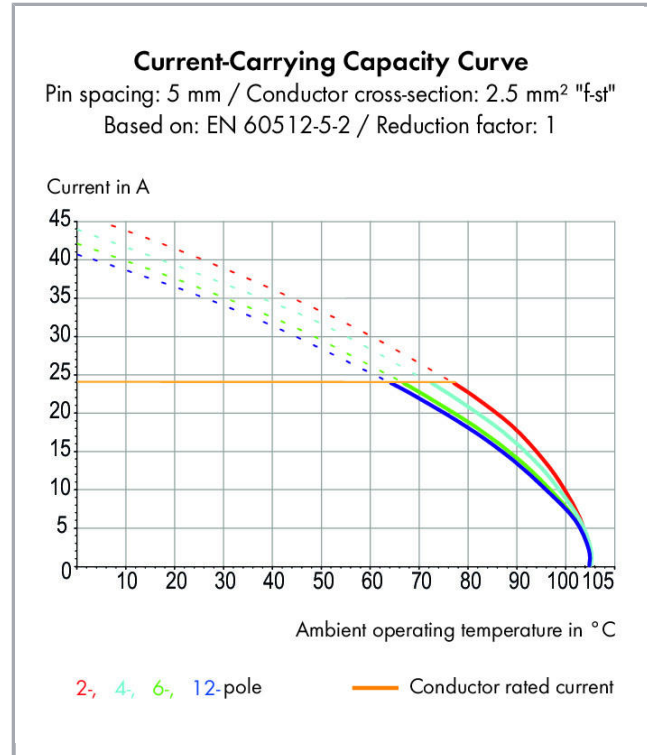
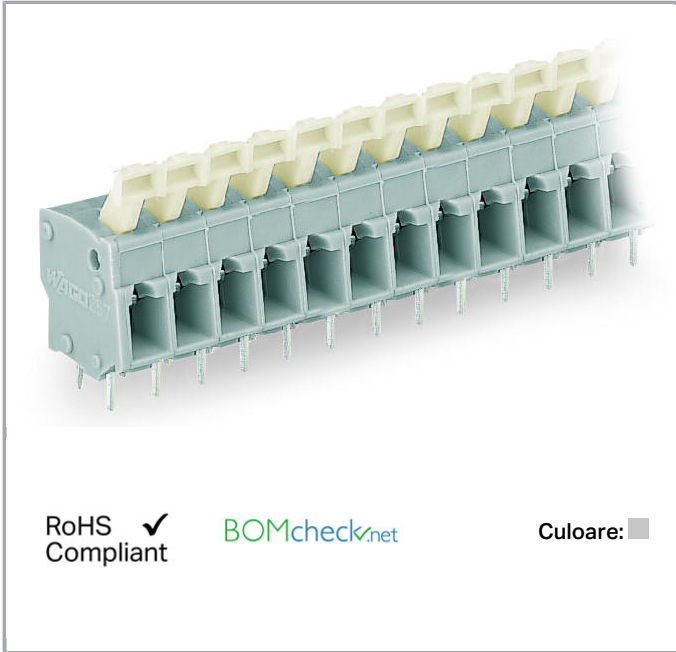

Descriere articol

Supus modificărilor.

WAGO Kontakttechnik GmbH & Co. KG
/Representative Office Romania
Sos. Pipera-Tunari nr. 1/1
building 1, 2nd floor | 077190 Voluntari, Ilfov
Tel.: +40-(0)31 421 85 68 | Email: info-RO@wago.com

Aveți întrebări despre produsele noastre?
Vă stăm la dispoziție pentru preluarea apelului la +40 (0) 31 421 85 68.



- Terminal strips with push-button actuated CAGE CLAMP®
- Set to metric or inch pin spacing by compressing terminal strips together or pulling them apart
- Ideal for in-the-field wiring thanks to simplified push-button actuation
- Convenient, tool-free operation

Date**Electrical data****Ratings per IEC/EN 60664-1**

Ratings per	ATEX: PTB 06 ATEX 1061 U / IECEx: PTB 06.0042 U
Legend (ratings)	(III / 2) \triangleq Overvoltage category III / Pollution degree 2

Approvals per UL 1059

Rated voltage UL (Use Group B)	300 V
Rated current UL (Use Group B)	15 A
Rated voltage UL (Use Group D)	300 V
Rated current UL (Use Group D)	10 A
Approvals per	UL 1059

Approvals per CSA

Rated voltage CSA (Use Group B)	300 V
Rated current CSA (Use Group B)	15 A
Rated voltage CSA (Use Group D)	300 V
Rated current CSA (Use Group D)	10 A

Approvals Ex

Rated voltage EN (Ex e II)	176 V
Rated current (Ex e II)	16 A

Connection data

Connection technology	CAGE CLAMP®
Actuation type	Push-button
Solid conductor	0.08 ... 2.5 mm ² / 28 ... 12 AWG
Fine-stranded conductor	0.08 ... 2.5 mm ² / 28 ... 12 AWG

Supus modificărilor.

WAGO Kontakttechnik GmbH & Co. KG
 /Representative Office Romania
 Sos. Pipera-Tunari nr. 1/1
 building 1, 2nd floor | 077190 Voluntari, Ilfov
 Tel.: +40-(0)31 421 85 68 | Email: info-RO@wago.com

Aveți întrebări despre produsele noastre?
 Vă stăm la dispoziție pentru preluarea apelului la +40 (0) 31 421 85 68.



Fine-stranded conductor; with insulated ferrule	0.25 ... 1.5 mm ²
Fine-stranded conductor; with uninsulated ferrule	0.25 ... 1.5 mm ²
Strip length	5 ... 6 mm / 0.2 ... 0.24 inch
Conductor connection direction to PCB	0°
Pole No.	7
Total number of connection points	7
Total number of potentials	7
Number of connection types	1
Number of levels	1
Note (conductor cross-section)	12 AWG: THHN, THWN

Geometrical Data

Pin spacing	5/5.08 mm / 0.197/0.2 inch
Width	37.9 mm / 1.492 inch
Height	24.4 mm / 0.961 inch
Height from the surface	20.4 mm / 0.803 inch
Depth	14.2 mm / 0.559 inch
Solder pin length	4 mm
Solder pin dimensions	0.7 x 0.7 mm
Drilled hole diameter with tolerance	1.1 (+0.1) mm

PCB contact

PCB contact	THT
Solder pin arrangement	over the entire terminal strip, in line
Number of solder pins per potential	2

Material Data

Color	light gray
Material group	I
Insulation material	Polyamide 66 (PA 66)
Flammability class per UL94	V0
Clamping spring material	Chrome nickel spring steel (CrNi)
Contact material	Electrolytic copper (E _{Cu})
Contact plating	tin-plated
Weight	1,1 g

Supus modificărilor.

WAGO Kontakttechnik GmbH & Co. KG
 /Representative Office Romania
 Sos. Pipera-Tunari nr. 1/1
 building 1, 2nd floor | 077190 Voluntari, Ilfov
 Tel.: +40-(0)31 421 85 68 | Email: info-RO@wago.com

Aveți întrebări despre produsele noastre?
 Vă stăm la dispoziție pentru preluarea apelului la +40 (0) 31 421 85 68.

Environmental Requirements



Limit temperature range -60 ... +105 °C

Commercial data

Packaging type	BOX
Country of origin	CH
GTIN	4017332629010
Customs tariff number	85369010000

Aprobări / certificate

Ex-Approvals

Emblemă	Aprobare	Text de aprobare suplimentar	Nume certificat
	AEx UL International Germany GmbH c/o Physikalisch Technische Bundesanstalt	UL 60079	E185892 sec.3
	ATEX Physikalisch Technische Bundesanstalt (PTB)	EN 60079	PTB 06 Atex 1061 U (II 2 G Ex eII bzw. I M2 Ex eI)
	IECEX Physikalisch Technische Bundesanstalt	IEC 60079	IECEX PTB 06.0042 U

Counterpart

Produse compatibile

check



Nr. articol: 249-110

Test plug adapter; suitable for 255, 256, 257 Series PCB terminal blocks; 1-pole; Pin spacing 5 mm / www.wago.com/249-110
0.197 in; gray

Nr. articol: 249-111

Supus modificărilor.

















WAGO Kontakttechnik GmbH & Co. KG
/Representative Office Romania
Sos. Pipera-Tunari nr. 1/1
building 1, 2nd floor | 077190 Voluntari, Ilfov
Tel.: +40-(0)31 421 85 68 | Email: info-RO@wago.com

Aveți întrebări despre produsele noastre?
Vă stăm la dispoziție pentru preluarea apelului la +40 (0) 31 421 85 68.



Test plug adapter; suitable for 255, 256, 257 Series PCB terminal blocks; 1-pole; Pin spacing 5.08 mm / 0.2 in; orange www.wago.com/249-111

















ferrule

	Nr. articol: 216-101 Ferrule; Sleeve for 0.5 mm ² / AWG 22; uninsulated; electro-tin plated	www.wago.com/216-101
	Nr. articol: 216-102 Ferrule; Sleeve for 0.75 mm ² / AWG 20; uninsulated; electro-tin plated	www.wago.com/216-102
	Nr. articol: 216-103 Ferrule; Sleeve for 1 mm ² / AWG 18; uninsulated; electro-tin plated	www.wago.com/216-103
	Nr. articol: 216-104 Ferrule; Sleeve for 1.5 mm ² / AWG 16; uninsulated; electro-tin plated	www.wago.com/216-104
	Nr. articol: 216-121 Ferrule; Sleeve for 0.5 mm ² / AWG 22; uninsulated; electro-tin plated	www.wago.com/216-121
	Nr. articol: 216-122 Ferrule; Sleeve for 0.75 mm ² / AWG 20; uninsulated; electro-tin plated	www.wago.com/216-122
	Nr. articol: 216-123 Ferrule; Sleeve for 1 mm ² / AWG 18; uninsulated; electro-tin plated	www.wago.com/216-123
	Nr. articol: 216-124 Ferrule; Sleeve for 1.5 mm ² / AWG 16; uninsulated; electro-tin plated	www.wago.com/216-124
	Nr. articol: 216-131 Ferrule; Sleeve for 0.25 mm ² / AWG 24; uninsulated; electro-tin plated	www.wago.com/216-131
	Nr. articol: 216-132 Ferrule; Sleeve for 0.34 mm ² / AWG 24; uninsulated; electro-tin plated	www.wago.com/216-132
	Nr. articol: 216-141 Ferrule; Sleeve for 0.5 mm ² / 20 AWG; uninsulated; electro-tin plated; electrolytic copper; gastight crimped; acc. to DIN 46228, Part 1/08.92	www.wago.com/216-141
	Nr. articol: 216-142 Ferrule; Sleeve for 0.75 mm ² / 18 AWG; uninsulated; electro-tin plated; electrolytic copper; gastight crimped; acc. to DIN 46228, Part 1/08.92	www.wago.com/216-142
	Nr. articol: 216-143 Ferrule; Sleeve for 1 mm ² / AWG 18; uninsulated; electro-tin plated; electrolytic copper; gastight crimped; acc. to DIN 46228, Part 1/08.92	www.wago.com/216-143
	Nr. articol: 216-144 Ferrule; Sleeve for 1.5 mm ² / AWG 16; uninsulated; electro-tin plated; electrolytic copper; gastight crimped; acc. to DIN 46228, Part 1/08.92	www.wago.com/216-144
	Nr. articol: 216-151 Ferrule; Sleeve for 0.25 mm ² / AWG 24; uninsulated; electro-tin plated	www.wago.com/216-151
	Nr. articol: 216-152 Ferrule; Sleeve for 0.34 mm ² / AWG 24; uninsulated; electro-tin plated	www.wago.com/216-152





Supus modificărilor.

WAGO Kontakttechnik GmbH & Co. KG
/Representative Office Romania
Sos. Pipera-Tunari nr. 1/1
building 1, 2nd floor | 077190 Voluntari, Ilfov
Tel.: +40-(0)31 421 85 68 | Email: info-RO@wago.com

Aveți întrebări despre produsele noastre?
Vă stăm la dispoziție pentru preluarea apelului la +40 (0) 31 421 85 68.

	Nr. articol: 216-201 Ferrule; Sleeve for 0.5 mm ² / 20 AWG; insulated; electro-tin plated; white	www.wago.com/216-201
	Nr. articol: 216-202 Ferrule; Sleeve for 0.75 mm ² / 18 AWG; insulated; electro-tin plated; gray	www.wago.com/216-202
	Nr. articol: 216-203 Ferrule; Sleeve for 1 mm ² / AWG 18; insulated; electro-tin plated; red	www.wago.com/216-203
	Nr. articol: 216-204 Ferrule; Sleeve for 1.5 mm ² / AWG 16; insulated; electro-tin plated; black	www.wago.com/216-204
	Nr. articol: 216-221 Ferrule; Sleeve for 0.5 mm ² / 20 AWG; insulated; electro-tin plated; white	www.wago.com/216-221
	Nr. articol: 216-222 Ferrule; Sleeve for 0.75 mm ² / 18 AWG; insulated; electro-tin plated; gray	www.wago.com/216-222
	Nr. articol: 216-223 Ferrule; Sleeve for 1 mm ² / AWG 18; insulated; electro-tin plated; red	www.wago.com/216-223
	Nr. articol: 216-224 Ferrule; Sleeve for 1.5 mm ² / AWG 16; insulated; electro-tin plated; black	www.wago.com/216-224
	Nr. articol: 216-241 Ferrule; Sleeve for 0.5 mm ² / 20 AWG; insulated; electro-tin plated; electrolytic copper; gastight crimped; acc. to DIN 46228, Part 4/09.90; white	www.wago.com/216-241
	Nr. articol: 216-242 Ferrule; Sleeve for 0.75 mm ² / 18 AWG; insulated; electro-tin plated; electrolytic copper; gastight crimped; acc. to DIN 46228, Part 4/09.90; gray	www.wago.com/216-242
	Nr. articol: 216-243 Ferrule; Sleeve for 1 mm ² / AWG 18; insulated; electro-tin plated; electrolytic copper; gastight crimped; acc. to DIN 46228, Part 4/09.90; red	www.wago.com/216-243
	Nr. articol: 216-244 Ferrule; Sleeve for 1.5 mm ² / AWG 16; insulated; electro-tin plated; electrolytic copper; gastight crimped; acc. to DIN 46228, Part 4/09.90; black	www.wago.com/216-244
	Nr. articol: 216-262 Ferrule; Sleeve for 0.75 mm ² / 18 AWG; insulated; electro-tin plated; electrolytic copper; gastight crimped; acc. to DIN 46228, Part 4/09.90; gray	www.wago.com/216-262
	Nr. articol: 216-263 Ferrule; Sleeve for 1 mm ² / AWG 18; insulated; electro-tin plated; electrolytic copper; gastight crimped; acc. to DIN 46228, Part 4/09.90; red	www.wago.com/216-263
	Nr. articol: 216-264 Ferrule; Sleeve for 1.5 mm ² / AWG 16; insulated; electro-tin plated; electrolytic copper; gastight crimped; acc. to DIN 46228, Part 4/09.90; black	www.wago.com/216-264
	Nr. articol: 216-284 Ferrule; Sleeve for 1.5 mm ² / AWG 16; insulated; electro-tin plated; electrolytic copper; gastight crimped; acc. to DIN 46228, Part 4/09.90; black	www.wago.com/216-284
	Nr. articol: 216-301 Ferrule; Sleeve for 0.25 mm ² / AWG 24; insulated; electro-tin plated; yellow	www.wago.com/216-301

Supus modificărilor.

	Nr. articol: 216-302 Ferrule; Sleeve for 0.34 mm ² / 22 AWG; insulated; electro-tin plated; green	www.wago.com/216-302
	Nr. articol: 216-321 Ferrule; Sleeve for 0.25 mm ² / AWG 24; insulated; electro-tin plated; yellow	www.wago.com/216-321
	Nr. articol: 216-322 Ferrule; Sleeve for 0.34 mm ² / 22 AWG; insulated; electro-tin plated; green	www.wago.com/216-322
Marking accessories		
	Nr. articol: 210-332/500-202 Marking strips; as a DIN A4 sheet; MARKED; 1-16 (160x); Height of marker strip: 3 mm; Strip length 182 mm; Horizontal marking; Self-adhesive; white	www.wago.com/210-332/500-202
	Nr. articol: 210-332/500-204 Marking strips; as a DIN A4 sheet; MARKED; 17-32 (160x); Height of marker strip: 3 mm; Strip length 182 mm; Horizontal marking; Self-adhesive; white	www.wago.com/210-332/500-204
	Nr. articol: 210-332/500-205 Marking strips; as a DIN A4 sheet; MARKED; 1-32 (80x); Height of marker strip: 3 mm; Strip length 182 mm; Horizontal marking; Self-adhesive; white	www.wago.com/210-332/500-205
	Nr. articol: 210-332/500-206 Marking strips; as a DIN A4 sheet; MARKED; 33-48 (160x); Height of marker strip: 3 mm; Strip length 182 mm; Horizontal marking; Self-adhesive; white	www.wago.com/210-332/500-206
	Nr. articol: 210-332/508-202 Marking strips; as a DIN A4 sheet; MARKED; 1-16 (160x); Height of marker strip: 3 mm; Strip length 182 mm; Horizontal marking; Self-adhesive; white	www.wago.com/210-332/508-202
	Nr. articol: 210-332/508-204 Marking strips; as a DIN A4 sheet; MARKED; 17-32 (160x); Height of marker strip: 3 mm; Strip length 182 mm; Horizontal marking; Self-adhesive; white	www.wago.com/210-332/508-204
	Nr. articol: 210-332/508-205 Marking strips; as a DIN A4 sheet; MARKED; 1-32 (80x); Height of marker strip: 3 mm; Strip length 182 mm; Horizontal marking; Self-adhesive; white	www.wago.com/210-332/508-205
	Nr. articol: 210-332/508-206 Marking strips; as a DIN A4 sheet; MARKED; 33-48 (160x); Height of marker strip: 3 mm; Strip length 182 mm; Horizontal marking; Self-adhesive; white	www.wago.com/210-332/508-206
tools		
	Nr. articol: 210-658 Operating tool; Blade: 3.5 x 0.5 mm; with a partially insulated shaft; angled; short	www.wago.com/210-658
	Nr. articol: 210-720 Operating tool; Blade: 3.5 x 0.5 mm; with a partially insulated shaft	www.wago.com/210-720

Descărcări Documentation

Supus modificărilor.

WAGO Kontakttechnik GmbH & Co. KG
/Representative Office Romania
Sos. Pipera-Tunari nr. 1/1
building 1, 2nd floor | 077190 Voluntari, Ilfov
Tel.: +40-(0)31 421 85 68 | Email: info-RO@wago.com

Aveți întrebări despre produsele noastre?
Vă stăm la dispoziție pentru preluarea apelului la +40 (0) 31 421 85 68.

**Additional Information**

Technical explanations

Apr 3, 2019

pdf
3,6 MB

Descărcare

CAD/CAE-Data**CAD data**

2D/3D Models 257-407/000-009/999-950

URL

Descărcare

CAE data

EPLAN Data Portal 257-407/000-009/999-950

URL

Descărcare

PCB Design

Symbol and Footprint 257-407/000-009/999-950

URL

Descărcare

CAX data for your PCB design, consisting of "schematic symbols and PCB footprints", allow easy integration of the WAGO component into your development environment.

Supported formats:

- Accel EDA 14 & 15
- Altium 6 to current version
- Cadence Allegro
- DesignSpark
- Eagle Libraries
- KiCad
- Mentor Graphics BoardStation
- Mentor Graphics Design Architect
- Mentor Graphics Design Expedition 99 and 2000
- OrCAD 9.X PCB and Capture
- PADS PowerPCB 3, 3.5, 4.X, and 5.X
- PADS PowerPCB and PowerLogic 3.0
- PCAD 2000, 2001, 2002, 2004, and 2006
- Pulsonix 8.5 or newer
- STL
- 3D STEP
- TARGET 3001!
- View Logic ViewDraw
- Quadcept

—
Supus modificărilor.

WAGO Kontakttechnik GmbH & Co. KG
/Representative Office Romania
Sos. Pipera-Tunari nr. 1/1
building 1, 2nd floor | 077190 Voluntari, Ilfov
Tel.: +40-(0)31 421 85 68 | Email: info-RO@wago.com

Aveți întrebări despre produsele noastre?

Vă stăm la dispoziție pentru preluarea apelului la +40 (0) 31 421 85 68.

- Zuken CadStar 3 and 4
- Zuken CR-5000 and CR-8000

PCB Component Libraries (EDA), PCB CAD Library Ultra Librarian

Installation Notes

Inserting a conductor

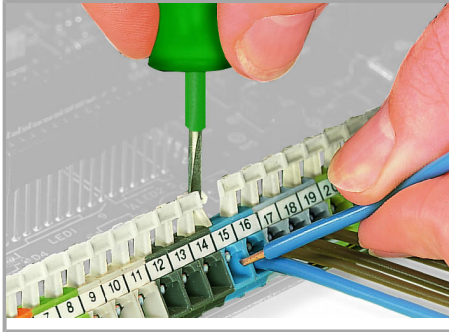

Inserting/removing a conductor – 256 Series.

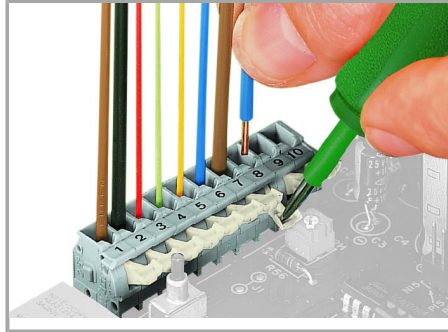

Inserting/removing a conductor – 255 Series.

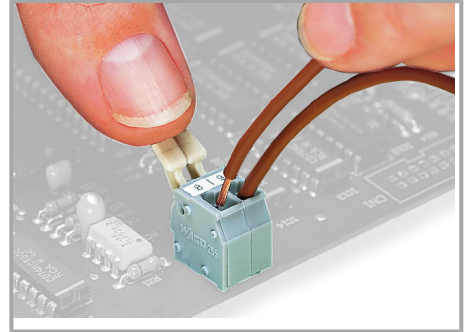

Inserting/removing a conductor via finger-operated lever – 255 Series.

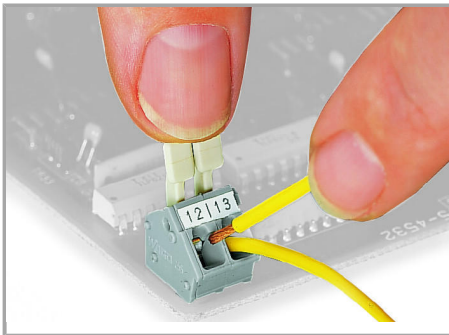

Inserting/removing a conductor via finger-operated lever – 256 Series.

Assembly

Supus modificărilor.

WAGO Kontakttechnik GmbH & Co. KG
/Representative Office Romania
Sos. Pipera-Tunari nr. 1/1
building 1, 2nd floor | 077190 Voluntari, Ilfov
Tel.: +40-(0)31 421 85 68 | Email: info-RO@wago.com

Aveți întrebări despre produsele noastre?
Vă stăm la dispoziție pentru preluarea apelului la +40 (0) 31 421 85 68.

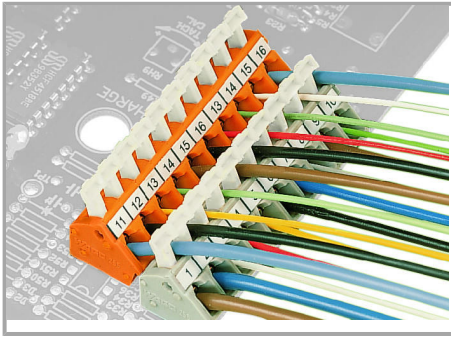

Possible conductor arrangement with terminal strips staggered (for 256 Series only).

Marking



Formation of groups using housings of different colors.

Testing

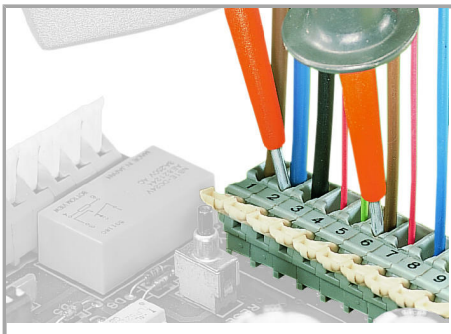

Testing with test probes.

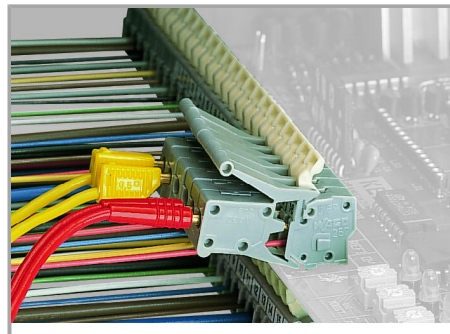

Testing with test plug modules.

Supus modificărilor.