

## Fișă tehnică | Număr articol: 774-9993/217-602

pre-assembled connecting cable; Eca; Plug/open-ended; 3-pole; Cod. A;  
H05Z1Z1-F 3G 2.5 mm<sup>2</sup>; 6 m; 2,50 mm<sup>2</sup>; white

[www.wago.com/774-9993/217-602](http://www.wago.com/774-9993/217-602)

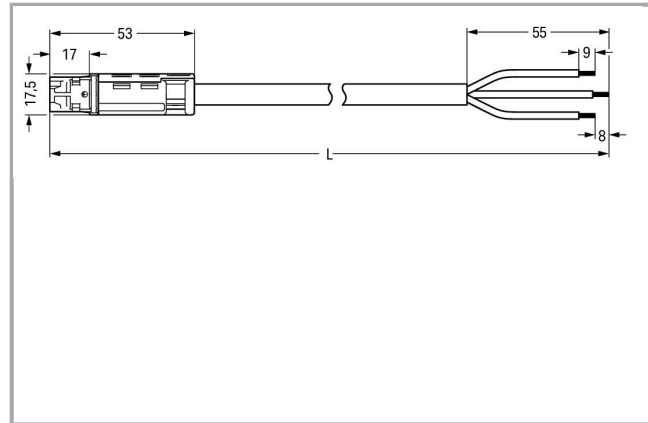
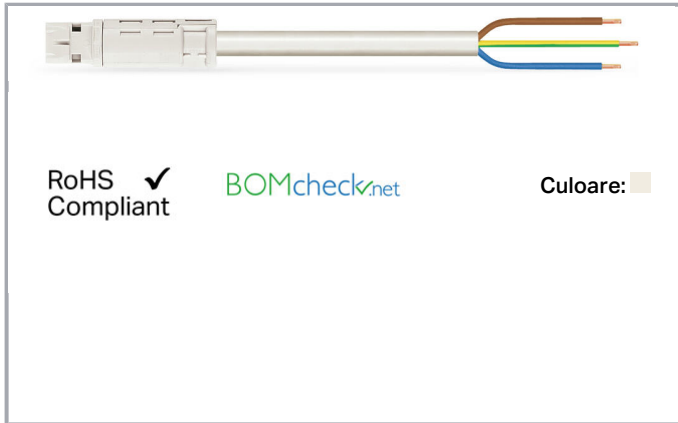

### Descriere articol

- For round conduits and ducts
- 3- and 4-pole preassembled cables with 17.5 mm outer diameter for easy plug & play
- Plug-in integration into the electrical installation of hollow-wall boxes via adapter, for example

### Note:

Cables with a different fire class can be found in the eShop.

### Note on mismatching protection:

All WINSTA<sup>®</sup> components are 100% protected against mismatching when:

- plugging different numbers of poles
- plugging while incorrectly rotated
- plugging while laterally staggered

### Date

#### Electrical data

Note on Contact Resistance

approx. 1 mΩ of contact resistance approx. 0.25 mΩ contact transition plug/socket

Supus modificărilor.

WAGO Kontakttechnik GmbH & Co. KG  
/Representative Office Romania  
Sos. Pipera-Tunari nr. 1/1  
building 1, 2nd floor | 077190 Voluntari, Ilfov  
Tel.: +40-(0)31 421 85 68 | Email: info-RO@wago.com

Aveți întrebări despre produsele noastre?  
Vă stăm la dispoziție pentru preluarea apelului la +40 (0) 31 421 85 68.

## Ratings per IEC/EN 60664-1

Ratings per	IEC/EN 60664-1
Nominal voltage (III/3)	250 V
Rated surge voltage (III/3)	4 kV
Rated current	20 A
Legend (ratings)	(III / 3) ≙ Overvoltage category III / Pollution degree 3

## Connection data

Pole No.	3
Total number of potentials	3
Ground function	with preceding ground contact
Conductor preparation	tip-bonded
Sheathed cable diameter	9,2 ... 11,4 mm
Wire cross-section	2,5 mm <sup>2</sup>
Strip length (outer insulation)	55 mm
Connection type	Plug - Free end

## Geometrical Data

Total length	6 m
--------------	-----

## Mechanical data

Mating force of a plug-in connection	approx. 30 ... 70 N (depending on pole number)
Retention force of a plug-in connection	when locked: > 80N
Unmating force of a plug-in connection	when unlocked: approx. 30 ... 70 N (depending on pole number)
Number of mating cycles	200, without resistive load 100, with resistive load $I_N = 20$ A, tested (2.5mm <sup>2</sup> /AWG 14)

Connection type	Plug - Free end
Type of pre-assembled cable	Connecting cable
Cable type	H05Z1Z1-F 3G2.5
Marking	L N
Protection type	IP20
Note on protection type	Only when mated (these compact connectors are not designed for use in open, easily accessible areas).

Supus modificărilor.

Application	General mains applications
-------------	----------------------------

### Plug connection

Mismating protection	Yes
Locking of plug-in connection	locking lever

### Material Data

Color	white
Insulation material	Polyamide 66 (PA 66)
Fire class per EN 50575	E <sub>ca</sub>
Contact material	Copper or copper alloy (surface-treated)
Fire load	13,826 MJ
Connector color	white
Strain relief color	white
Halogen-free	Yes
Weight	892,3 g

### Environmental Requirements

Processing temperature	-5 ... +40 °C
Continuous operating temperature	-35 ... +85 °C
Note on continuous operating temperature	PVC cable for temperatures ≤ 70 °C (including halogen-free) Insulating parts for temperatures ≤ 105 °C

### Commercial data

Packaging type	not packed
Country of origin	DE
GTIN	4045454324872
Customs tariff number	85444290900

### Aprobări / certificate

#### Country specific Approvals

Emblemă	Aprobare	Text de aprobare suplimentar	Nume certificat
	KEMA/KEUR DEKRA Certification B.V.	-	2118353.02

Supus modificărilor.

WAGO Kontakttechnik GmbH & Co. KG  
/Representative Office Romania  
Sos. Pipera-Tunari nr. 1/1  
building 1, 2nd floor | 077190 Voluntari, Ilfov  
Tel.: +40-(0)31 421 85 68 | Email: info-RO@wago.com

Aveți întrebări despre produsele noastre?  
Vă stăm la dispoziție pentru preluarea apelului la +40 (0) 31 421 85 68.



## Counterpart

### Descărcări CAD/CAE-Data

#### CAE data

WSCAD Universe 774-9993/217-602

URL

Descărcare

---

## Installation Notes

### Familie de produse

*WINSTA*® RD

Afișare globală produse din familie.

Supus modificărilor.

---

WAGO Kontakttechnik GmbH & Co. KG  
/Representative Office Romania  
Sos. Pipera-Tunari nr. 1/1  
building 1, 2nd floor | 077190 Voluntari, Ilfov  
Tel.: +40-(0)31 421 85 68 | Email: info-RO@wago.com

Aveți întrebări despre produsele noastre?  
Vă stăm la dispoziție pentru preluarea apelului la +40 (0) 31 421 85 68.