

## Fișă tehnică | Număr articol: 252-304

2-conductor modular PCB connector; push-button; 0.8 mm Ø; Pin spacing 3.5 mm; 4-pole; 0,50 mm<sup>2</sup>; gray

[www.wago.com/252-304](http://www.wago.com/252-304)

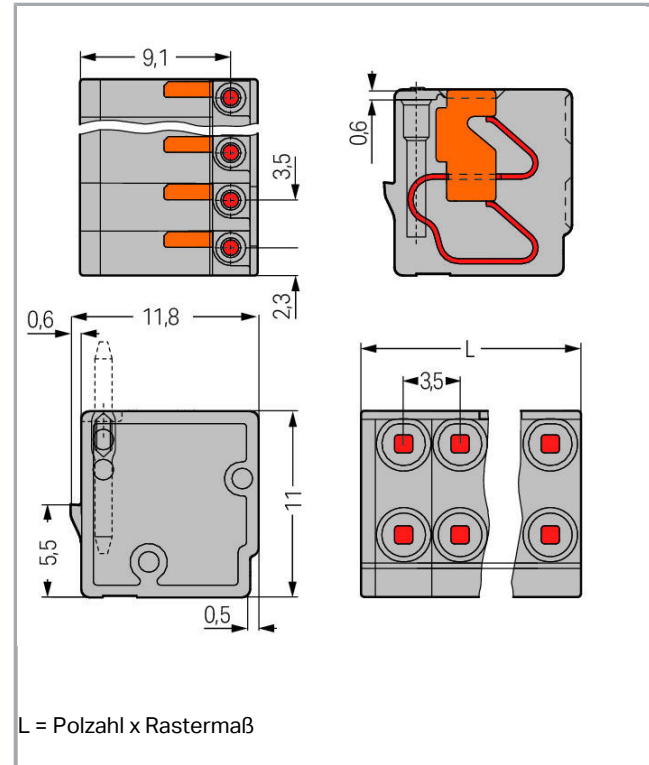

### Descriere articol

- Compact, 2-conductor PCB connectors with push-buttons and PUSH WIRE<sup>®</sup> connection
- Push-in termination of solid conductors – conductor removal via push-buttons
- Double entries for power supply and distribution
- Quick and easy PCB replacement
- Loop connection is retained, even when unmated
- Group arrangement is possible without losing any poles
- KNX compatible

### Date

#### Electrical data

Supus modificărilor.

WAGO Kontakttechnik GmbH & Co. KG  
/Representative Office Romania  
Sos. Pipera-Tunari nr. 1/1  
building 1, 2nd floor | 077190 Voluntari, Ilfov  
Tel.: +40-(0)31 421 85 68 | Email: info-RO@wago.com

Aveți întrebări despre produsele noastre?  
Vă stăm la dispoziție pentru preluarea apelului la +40 (0) 31 421 85 68.

### Ratings per IEC/EN 60664-1

Ratings per	IEC/EN 60664-1
Nominal voltage (III/3)	160 V
Rated surge voltage (III/3)	2,5 kV
Rated voltage (III/2)	160 V
Rated surge voltage (III/2)	2,5 kV
Nominal voltage (II/2)	320 V
Rated surge voltage (II/2)	2,5 kV
Rated current	2 A
Legend (ratings)	(III / 2) $\triangleq$ Overvoltage category III / Pollution degree 2

### Approvals per UL 1059

Rated voltage UL (Use Group B)	300 V
Rated current UL (Use Group B)	2 A
Rated voltage UL (Use Group D)	300 V
Rated current UL (Use Group D)	2 A
Approvals per	UL 1059

### Connection data

Connection technology	PUSH WIRE <sup>®</sup>
Actuation type	Push-button
Solid conductor	0,14 ... 0,5 mm <sup>2</sup> / 26 ... 20 AWG
Conductor diameter	0,4 ... 0,8 mm
Strip length	6 ... 7 mm / 0.24 ... 0.28 inch
Conductor connection direction to PCB	0°
Pole No.	4
Total number of potentials	4
Number of connection types	1
Number of levels	1

### Geometrical Data

Pin spacing	3,5 mm / 0.138 inch
Width	14,0 mm / 0.551 inch

Supus modificărilor.

## Plug connection

Contact type (pluggable connector)	Female connector/socket
Connector (connection type)	for PCB
Mating direction to the PCB	90°

## PCB contact

PCB contact	THT
-------------	-----

## Material Data

Color	gray
Material group	I
Insulation material	Polyamide 66 (PA 66)
Flammability class per UL94	V0
Clamping spring material	Copper alloy
Contact material	Electrolytic copper (E <sub>Cu</sub> )
Contact plating	tin-plated
Weight	1,9 g

## Environmental Requirements

Limit temperature range	-60 ... +105 °C
-------------------------	-----------------

## Commercial data

Packaging type	BOX
Country of origin	PL
GTIN	4055143959421
Customs tariff number	85369010000

## Counterpart

## Produse compatibile

### tools



Nr. articol: 210-647

Operating tool; Blade: 2.5 x 0.4 mm; with a partially insulated shaft

[www.wago.com/210-647](http://www.wago.com/210-647)

Supus modificărilor.



Nr. articol: 210-719

Operating tool; Blade: 2.5 x 0.4 mm; with a partially insulated shaft

[www.wago.com/210-719](http://www.wago.com/210-719)

## Descărcări Documentation

### Additional Information

Technical explanations

Apr 3, 2019

pdf  
3,6 MB

Descărcare

## Installation Notes

### Conductor termination

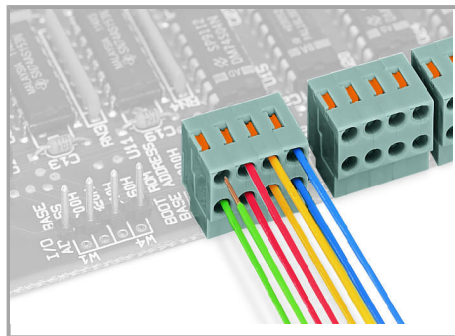

Conductor termination directly on the PCB or wiring prior to mounting on PCB – 252 Series

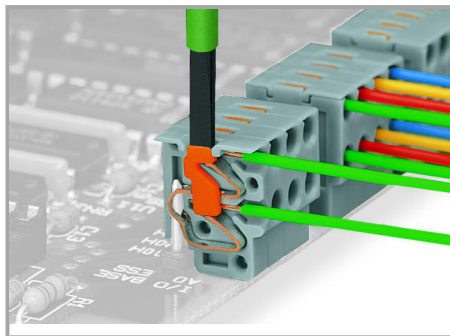

Removing a conductor via push-button – 252 Series

### Installation

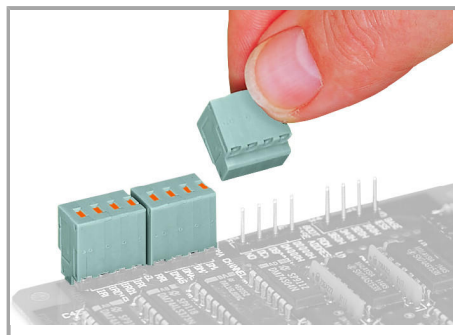

Plugging a compact PCB connector – 252 Series.

Supus modificărilor.