

Fișă tehnică | Număr articol: 232-540/007-000

Double pin header; DIN-35 rail mounting; Pin spacing 5.08 mm; 10-pole;
orange

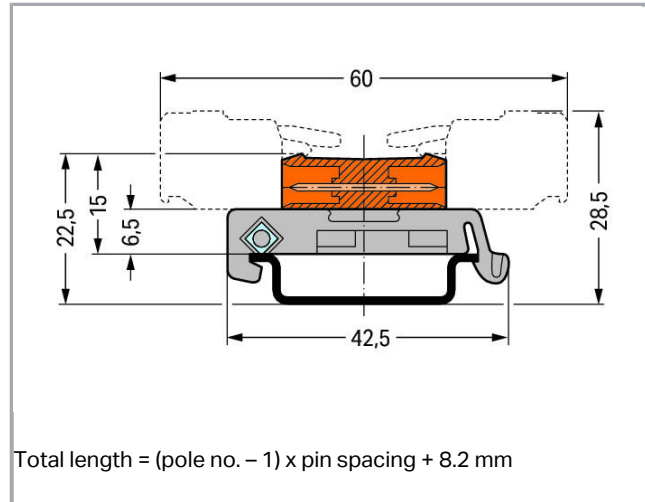

www.wago.com/232-540/007-000

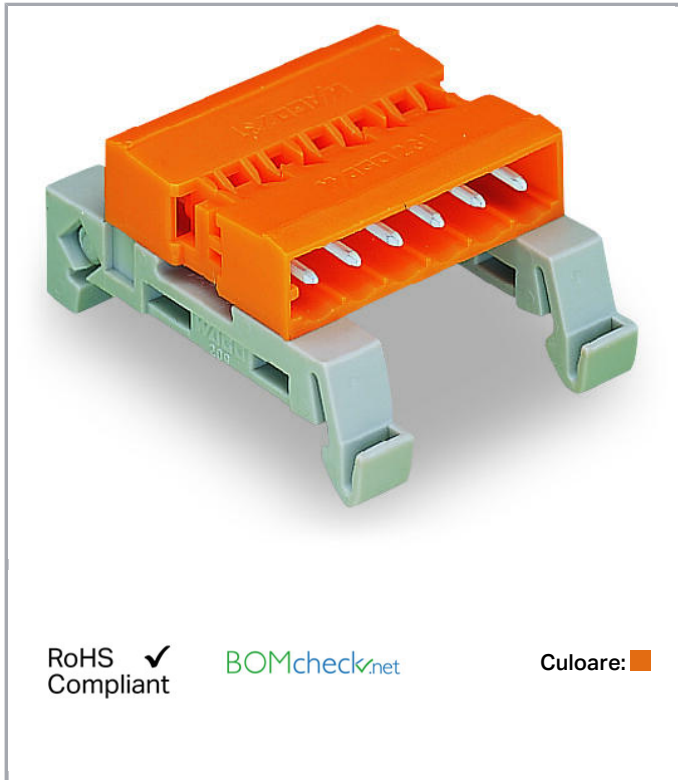

RoHS Compliant

BOMcheck.net

Culoare:

Descriere articol

- Allow MCS Female Connectors fitted with wire harness or cable assembly to be plugged together
- Adapter for DIN-35 rail mounting
- Coding via coding keys on both sides

Safety information 1:

The *MULTI CONNECTION SYSTEM (MCS)* is designed without breaking capacity for compliance with DIN EN 61984. When used as intended, MCS Connectors shall not be connected/disconnected when live or under load. The circuit design should ensure header pins, which can be touched, are not live when unmated.

Date

Electrical data

Supus modificărilor.

WAGO Kontakttechnik GmbH & Co. KG
/Representative Office Romania
Sos. Pipera-Tunari nr. 1/1
building 1, 2nd floor | 077190 Voluntari, Ilfov
Tel.: +40-(0)31 421 85 68 | Email: info-RO@wago.com

Aveți întrebări despre produsele noastre?

Vă stăm la dispoziție pentru preluarea apelului la +40 (0) 31 421 85 68.



Ratings per IEC/EN 60664-1

Ratings per	IEC/EN 60664-1
Ratings (note)	Notice: Male connectors shall not be live when disconnected!
Nominal voltage (III/3)	250 V
Rated surge voltage (III/3)	4 kV
Rated voltage (III/2)	320 V
Rated surge voltage (III/2)	4 kV
Nominal voltage (II/2)	630 V
Rated surge voltage (II/2)	4 kV
Rated current	12 A
Legend (ratings)	(III / 2) \triangleq Overvoltage category III / Pollution degree 2

Approvals per UL 1059

Rated voltage UL (Use Group B)	300 V
Rated current UL (Use Group B)	15 A
Rated voltage UL (Use Group D)	300 V
Rated current UL (Use Group D)	10 A
Approvals per	UL 1059

Approvals per UL 1977

Rated voltage UL 1977	600 V
Rated current UL 1977	15 A

Approvals per CSA

Rated voltage CSA (Use Group B)	300 V
Rated current CSA (Use Group B)	15 A
Rated voltage CSA (Use Group D)	300 V
Rated current CSA (Use Group D)	10 A

Connection data

Pole No.	10
Total number of potentials	10
Number of connection types	1
Number of levels	1

Supus modificărilor.

WAGO Kontakttechnik GmbH & Co. KG
 /Representative Office Romania
 Sos. Pipera-Tunari nr. 1/1
 building 1, 2nd floor | 077190 Voluntari, Ilfov
 Tel.: +40-(0)31 421 85 68 | Email: info-RO@wago.com

Aveți întrebări despre produsele noastre?
 Vă stăm la dispoziție pentru preluarea apelului la +40 (0) 31 421 85 68.



Geometrical Data

Pin spacing	5.08 mm / 0.2 inch
Width	54 mm / 2.126 inch
Height from upper-edge of DIN-rail	15 mm / 0.591 inch
Depth	42.5 mm / 1.673 inch

Mechanical data

Mounting type	DIN-35 rail
---------------	-------------

Plug connection

Contact type (pluggable connector)	Male connector/plug
Connector (connection type)	for pluggable connectors
Mismating protection	No

Material Data

Color	orange
Material group	I
Insulation material	Polyamide 66 (PA 66)
Flammability class per UL94	V0
Contact material	Electrolytic copper (E _{Cu})
Contact plating	tin-plated
Fire load	0,208 MJ
Weight	9,8 g

Environmental Requirements

Limit temperature range	-60 ... +100 °C
-------------------------	-----------------

Commercial data

Product Group	3 (Multi Conn. System)
Packaging type	BOX
Country of origin	DE
GTIN	4045454339951
Customs tariff number	85366990990

Supus modificărilor.

WAGO Kontakttechnik GmbH & Co. KG
 /Representative Office Romania
 Sos. Pipera-Tunari nr. 1/1
 building 1, 2nd floor | 077190 Voluntari, Ilfov
 Tel.: +40-(0)31 421 85 68 | Email: info-RO@wago.com



Aveți întrebări despre produsele noastre?
 Vă stăm la dispoziție pentru preluarea apelului la +40 (0) 31 421 85 68.

Aprobări / certificate



Country specific Approvals

Emblemă	Aprobare	Text de aprobare suplimentar	Nume certificat
	KEMA/KEUR DEKRA Certification B.V.	EN 61984	2190761.01

Ship Approvals

Emblemă	Aprobare	Text de aprobare suplimentar	Nume certificat
	ABS American Bureau of Shipping	-	19- HG15869876- PDA
	DNV GL Det Norske Veritas, Germanischer Lloyd	EN 60998	TAE000016Z

UL-Approvals

Emblemă	Aprobare	Text de aprobare suplimentar	Nume certificat
	UL UL International Germany GmbH	UL 1977	E45171
	UR Underwriters Laboratories Inc.	UL 1059	E45172 sec. 18

Counterpart



Nr. articol 231-310/026-000

1-conductor female plug; 2.5 mm²; Pin spacing 5.08 mm; 10-pole; 2,50 mm²; orangewww.wago.com/231-310/026-000









Supus modificărilor.

WAGO Kontakttechnik GmbH & Co. KG
/Representative Office Romania
Sos. Pipera-Tunari nr. 1/1
building 1, 2nd floor | 077190 Voluntari, Ilfov
Tel.: +40-(0)31 421 85 68 | Email: info-RO@wago.com

Aveți întrebări despre produsele noastre?
Vă stăm la dispoziție pentru preluarea apelului la +40 (0) 31 421 85 68.

Produse compatibile

Carrier rail

	Nr. articol: 210-112 Steel carrier rail; 35 x 7.5 mm; 1 mm thick; 2 m long; slotted; according to EN 60715; "Hole width 25 mm	www.wago.com/210-112
	Nr. articol: 210-113 Steel carrier rail; 35 x 7.5 mm; 1 mm thick; 2 m long; unslotted; according to EN 60715	www.wago.com/210-113
	Nr. articol: 210-114 Steel carrier rail; 35 x 15 mm; 1.5 mm thick; 2 m long; unslotted; similar to EN 60715	www.wago.com/210-114
	Nr. articol: 210-115 Steel carrier rail; 35 x 7.5 mm; 1 mm thick; 2 m long; slotted; according to EN 60715; "Hole width 18 mm	www.wago.com/210-115
	Nr. articol: 210-118 Steel carrier rail; 35 x 15 mm; 2.3 mm thick; 2 m long; unslotted; according to EN 60715	www.wago.com/210-118
	Nr. articol: 210-196 Aluminum carrier rail; 35 x 8.2 mm; 1.6 mm thick; 2 m long; unslotted; similar to EN 60715; silver-colored	www.wago.com/210-196
	Nr. articol: 210-197 Steel carrier rail; 35 x 15 mm; 1.5 mm thick; 2 m long; slotted; similar to EN 60715	www.wago.com/210-197
	Nr. articol: 210-198 Copper carrier rail; 35 x 15 mm; 2.3 mm thick; 2 m long; unslotted; according to EN 60715; copper-colored	www.wago.com/210-198
	Nr. articol: 210-504 Steel carrier rail; 35 x 7.5 mm; 1 mm thick; 2 m long; slotted; galvanized; according to EN 60715	www.wago.com/210-504
	Nr. articol: 210-505 Steel carrier rail; 35 x 7.5 mm; 1 mm thick; 2 m long; unslotted; galvanized; according to EN 60715	www.wago.com/210-505
	Nr. articol: 210-506 Steel carrier rail; 35 x 15 mm; 1.5 mm thick; 2 m long; unslotted; galvanized; similar to EN 60715	www.wago.com/210-506
	Nr. articol: 210-508 Steel carrier rail; 35 x 15 mm; 1.5 mm thick; 2 m long; slotted; galvanized; similar to EN 60715	www.wago.com/210-508

Coding

	Nr. articol: 231-129 Coding key; snap-on type; light gray	www.wago.com/231-129
------------------------------------------------------------------------------------	---------------------------------------------------------------------	----------------------------------------------------------------

Marking accessories

	Nr. articol: 210-833 Marking strips; on reel; 6 mm wide; plain; Self-adhesive; white	www.wago.com/210-833
------------------------------------------------------------------------------------	------------------------------------------------------------------------------------------------	----------------------------------------------------------------

Nr. articol: 210-834

Supus modificărilor.



Marking strips; on reel; 5 mm wide; plain; Self-adhesive; white

Descărcări Documentation

Additional Information

Technical explanations	Apr 3, 2019	pdf 3,6 MB	Descărcare
------------------------	-------------	---------------	------------

CAD/CAE-Data

CAD data

2D/3D Models 232-540/007-000	URL	Descărcare
------------------------------	-----	------------

CAE data

EPLAN Data Portal 232-540/007-000	URL	Descărcare
-----------------------------------	-----	------------

Installation Notes

Application

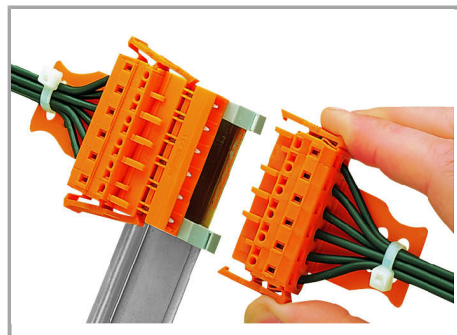

Female connectors with locking levers

Familie de produse

MCS MIDI Classic

Afișare globală produse din familie.

Supus modificărilor.

WAGO Kontakttechnik GmbH & Co. KG
/Representative Office Romania
Sos. Pipera-Tunari nr. 1/1
building 1, 2nd floor | 077190 Voluntari, Ilfov
Tel.: +40-(0)31 421 85 68 | Email: info-RO@wago.com

Aveți întrebări despre produsele noastre?
Vă stăm la dispoziție pentru preluarea apelului la +40 (0) 31 421 85 68.