

Fișă tehnică | Număr articol: 231-865/001-000/105-604

THR male header; 1.2 x 1.2 mm solder pin; angled; Pin spacing 7.5 mm; 5-pole; black

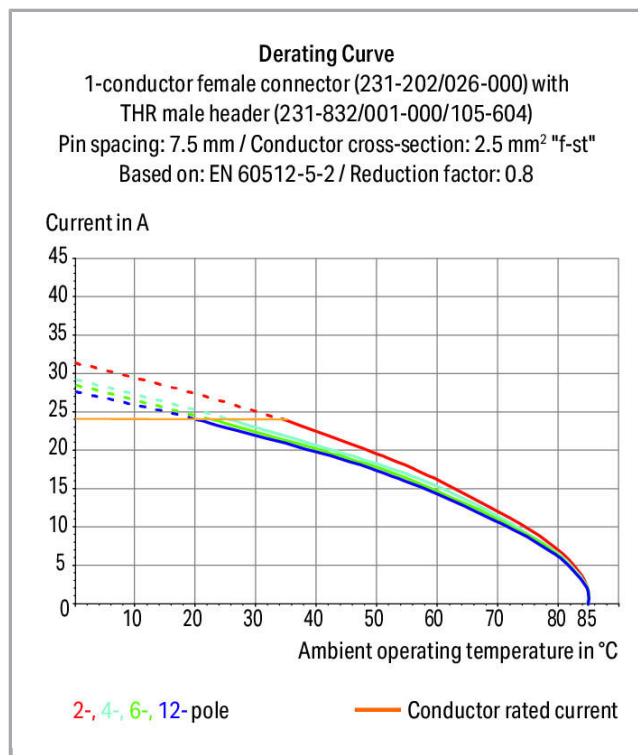

www.wago.com/231-865/001-000/105-604

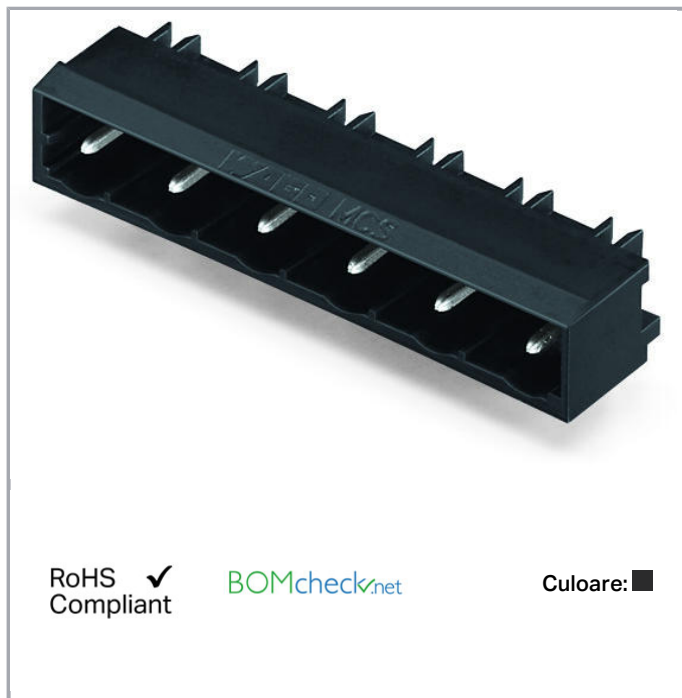

Supus modificărilor.

WAGO Kontakttechnik GmbH & Co. KG
/Representative Office Romania
Sos. Pipera-Tunari nr. 1/1
building 1, 2nd floor | 077190 Voluntari, Ilfov
Tel.: +40-(0)31 421 85 68 | Email: info-RO@wago.com

Aveți întrebări despre produsele noastre?
Vă stăm la dispoziție pentru preluarea apelului la +40 (0) 31 421 85 68.

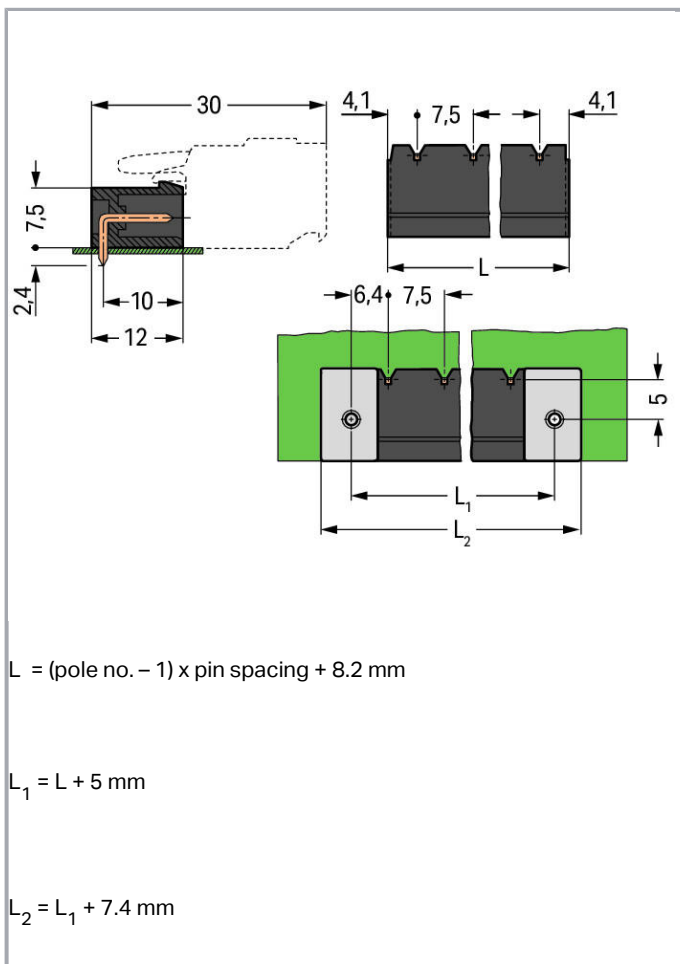

Descriere articol

- THR male headers for reflow soldering in SMT applications
- Available in tape-and-reel packaging for automated pick-and-place PCB assembly
- 1.2 x 1.2 mm solder pins allow nominal current up to 16 A, enhancing stability of shorter headers
- Also available in bulk packaging for manual placement
- Male headers may be mounted horizontally or vertically
- With coding fingers

Safety information 1:

The *MULTI CONNECTION SYSTEM (MCS)* is designed without breaking capacity for compliance with DIN EN 61984. When used as intended, MCS Connectors shall not be connected/disconnected when live or under load. The circuit design should ensure header pins, which can be touched, are not live when unmated.

Supus modificărilor.

WAGO Kontakttechnik GmbH & Co. KG
 /Representative Office Romania
 Sos. Pipera-Tunari nr. 1/1
 building 1, 2nd floor | 077190 Voluntari, Ilfov
 Tel.: +40-(0)31 421 85 68 | Email: info-RO@wago.com

Aveți întrebări despre produsele noastre?
 Vă stăm la dispoziție pentru preluarea apelului la +40 (0) 31 421 85 68.

Date

Electrical data

Ratings per IEC/EN 60664-1

Ratings per	IEC/EN 60664-1
Nominal voltage (III/3)	500 V
Rated surge voltage (III/3)	6 kV
Rated voltage (III/2)	630 V
Rated surge voltage (III/2)	6 kV
Nominal voltage (II/2)	1000 V
Rated surge voltage (II/2)	6 kV
Rated current	16 A
Legend (ratings)	(III / 2) ≙ Overvoltage category III / Pollution degree 2

Approvals per UL 1059

Rated voltage UL (Use Group B)	300 V
Rated current UL (Use Group B)	10 A
Rated voltage UL (Use Group D)	300 V
Rated current UL (Use Group D)	10 A
Approvals per	UL 1059

Approvals per UL 1977

Rated voltage UL 1977	600 V
Rated current UL 1977	15 A

Approvals per CSA

Rated voltage CSA (Use Group B)	300 V
Rated current CSA (Use Group B)	10 A
Rated voltage CSA (Use Group D)	300 V
Rated current CSA (Use Group D)	10 A

Connection data

Pole No.	5
Total number of potentials	5
Number of connection types	1
Number of levels	1

Supus modificărilor.



Geometrical Data

Pin spacing	7.5 mm / 0.295 inch
Width	38 mm / 1.496 inch
Height	10.8 mm / 0.425 inch
Height from the surface	8.4 mm / 0.331 inch
Depth	12 mm / 0.472 inch
Solder pin length	2,4 mm
Solder pin dimensions	1.2 x 1.2 mm
Plated through-hole diameter (THR)	1.7 ^(+0.1) mm

Plug connection

Contact type (pluggable connector)	Male connector/plug
Connector (connection type)	for PCBs
Mismatching protection	No
Mating direction to the PCB	0°

PCB contact

PCB contact	THR
Solder pin arrangement	over the entire male connector, in line
Number of solder pins per potential	1

Material Data

Color	black
Material group	I
Insulation material	Polyphthalamide (PPA GF)
Flammability class per UL94	V0
Contact material	Electrolytic copper (E _{Cu})
Contact plating	tin-plated
Weight	2,6 g

Environmental Requirements

Limit temperature range	-60 ... +100 °C
-------------------------	-----------------

Supus modificărilor.

WAGO Kontakttechnik GmbH & Co. KG
 /Representative Office Romania
 Sos. Pipera-Tunari nr. 1/1
 building 1, 2nd floor | 077190 Voluntari, Ilfov
 Tel.: +40-(0)31 421 85 68 | Email: info-RO@wago.com



Aveți întrebări despre produsele noastre?
 Vă stăm la dispoziție pentru preluarea apelului la +40 (0) 31 421 85 68.

Commercial data



Product Group	3 (Multi Conn. System)
Packaging type	BOX
Country of origin	PL
GTIN	4045454901325
Customs tariff number	85366990990

Aprobări / certificate

Country specific Approvals

Emblemă	Aprobare	Text de aprobare suplimentar	Nume certificat
	CSA DEKRA Certification B.V.	C22.2	1466354
	KEMA/KEUR DEKRA Certification B.V.	EN 61984	2190761.01

UL-Approvals

Emblemă	Aprobare	Text de aprobare suplimentar	Nume certificat
	UR Underwriters Laboratories Inc.	UL 1059	E45172
	UR Underwriters Laboratories Inc.	UL 1977	20150318- E45171

Counterpart



Nr. articol 231-205/026-000

1-conductor female plug; 2.5 mm²; Pin spacing 7.5 mm; 5-pole; 2,50 mm²; gray

www.wago.com/231-205/026-000

Supus modificărilor.

WAGO Kontakttechnik GmbH & Co. KG
/Representative Office Romania
Sos. Pipera-Tunari nr. 1/1
building 1, 2nd floor | 077190 Voluntari, Ilfov
Tel.: +40-(0)31 421 85 68 | Email: info-RO@wago.com

Aveți întrebări despre produsele noastre?
Vă stăm la dispoziție pentru preluarea apelului la +40 (0) 31 421 85 68.

Produse compatibile

Coding



Nr. articol: 231-130

Coding key; snap-on type; light gray

www.wago.com/231-130



Nr. articol: 231-500

Spacer; for formation of groups; light gray

www.wago.com/231-500

Marking accessories



Nr. articol: 210-833

Marking strips; on reel; 6 mm wide; plain; Self-adhesive; white

www.wago.com/210-833



Nr. articol: 210-834

Marking strips; on reel; 5 mm wide; plain; Self-adhesive; white

www.wago.com/210-834

Descărcări

Documentation

Additional Information

Technical explanations

Apr 3, 2019

pdf
3,6 MB

Descărcare

CAD/CAE-Data

CAD data

2D/3D Models 231-865/001-000/105-604

URL

Descărcare

Installation Notes

Coding

Supus modificărilor.

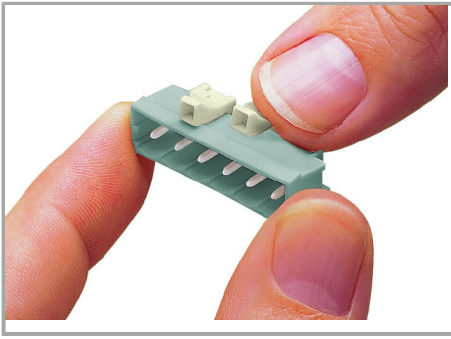

Coding a male header – fitting coding key(s).

Familie de produse

MCS MIDI Classic

Afișare globală produse din familie.

Supus modificărilor.