

Fișă tehnică | Număr articol: 231-833/001-000/105-604

THR male header; 1.0 x 1.0 mm solder pin; angled; Pin spacing 7.5 mm; 3-pole; black

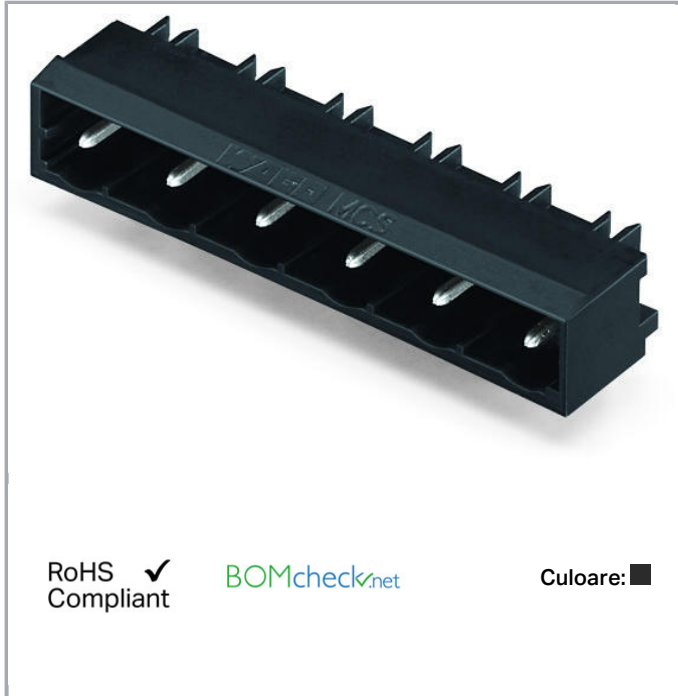

[www.wago.com/231-833/001-000/105-604](http://www.wago.com/231-833/001-000/105-604)



Supus modificărilor.

WAGO Kontakttechnik GmbH & Co. KG  
/Representative Office Romania  
Sos. Pipera-Tunari nr. 1/1  
building 1, 2nd floor | 077190 Voluntari, Ilfov  
Tel.: +40-(0)31 421 85 68 | Email: info-RO@wago.com

Aveți întrebări despre produsele noastre?  
Vă stăm la dispoziție pentru preluarea apelului la +40 (0) 31 421 85 68.

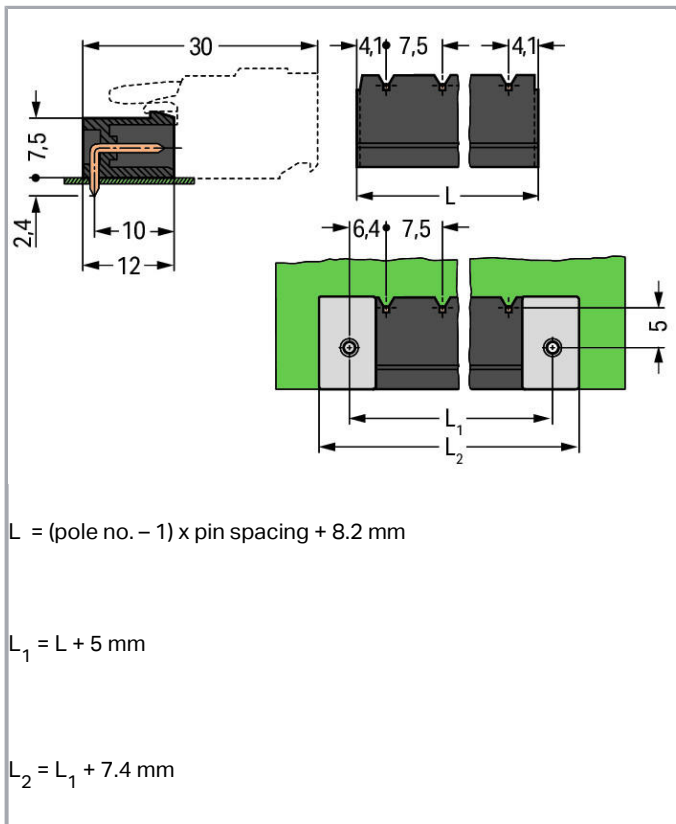

## Descriere articol

- THR male headers for reflow soldering in SMT applications
- Available in tape-and-reel packaging for automated pick-and-place PCB assembly
- Also available in bulk packaging for manual placement
- Male headers may be mounted horizontally or vertically
- With coding fingers

### Safety information 1:

The *MULTI CONNECTION SYSTEM (MCS)* is designed without breaking capacity for compliance with DIN EN 61984. When used as intended, MCS Connectors shall not be connected/disconnected when live or under load. The circuit design should ensure header pins, which can be touched, are not live when unmated.

## Date

## Electrical data

Supus modificărilor.

WAGO Kontakttechnik GmbH & Co. KG  
 /Representative Office Romania  
 Sos. Pipera-Tunari nr. 1/1  
 building 1, 2nd floor | 077190 Voluntari, Ilfov  
 Tel.: +40-(0)31 421 85 68 | Email: info-RO@wago.com

Aveți întrebări despre produsele noastre?

Vă stăm la dispoziție pentru preluarea apelului la +40 (0) 31 421 85 68.



### Ratings per IEC/EN 60664-1

Ratings per	IEC/EN 60664-1
Nominal voltage (III/3)	500 V
Rated surge voltage (III/3)	6 kV
Rated voltage (III/2)	630 V
Rated surge voltage (III/2)	6 kV
Nominal voltage (II/2)	1000 V
Rated surge voltage (II/2)	6 kV
Rated current	12 A
Legend (ratings)	(III / 2) $\triangleq$ Overvoltage category III / Pollution degree 2

### Approvals per UL 1059

Rated voltage UL (Use Group B)	300 V
Rated current UL (Use Group B)	10 A
Rated voltage UL (Use Group D)	300 V
Rated current UL (Use Group D)	10 A
Approvals per	UL 1059

### Approvals per UL 1977

Rated voltage UL 1977	600 V
Rated current UL 1977	10 A

### Approvals per CSA

Rated voltage CSA (Use Group B)	300 V
Rated current CSA (Use Group B)	10 A
Rated voltage CSA (Use Group D)	300 V
Rated current CSA (Use Group D)	10 A

### Connection data

Pole No.	3
Total number of potentials	3
Number of connection types	1
Number of levels	1

Supus modificărilor.

WAGO Kontakttechnik GmbH & Co. KG  
 /Representative Office Romania  
 Sos. Pipera-Tunari nr. 1/1  
 building 1, 2nd floor | 077190 Voluntari, Ilfov  
 Tel.: +40-(0)31 421 85 68 | Email: info-RO@wago.com

Aveți întrebări despre produsele noastre?  
 Vă stăm la dispoziție pentru preluarea apelului la +40 (0) 31 421 85 68.



## Geometrical Data

Pin spacing	7.5 mm / 0.295 inch
Width	23 mm / 0.906 inch
Height	10.8 mm / 0.425 inch
Height from the surface	8.4 mm / 0.331 inch
Depth	12 mm / 0.472 inch
Solder pin length	2,4 mm
Solder pin dimensions	1 x 1 mm
Plated through-hole diameter (THR)	1.4 <sup>(+0.1)</sup> mm

## Plug connection

Contact type (pluggable connector)	Male connector/plug
Connector (connection type)	for PCBs
Mismating protection	No
Mating direction to the PCB	0°

## PCB contact

PCB contact	THR
Solder pin arrangement	over the entire male connector, in line
Number of solder pins per potential	1

## Material Data

Color	black
Material group	I
Insulation material	Polyphthalamide (PPA GF)
Flammability class per UL94	V0
Contact material	Electrolytic copper (E <sub>Cu</sub> )
Contact plating	tin-plated
Fire load	0,032 MJ
Weight	1,4 g

## Environmental Requirements

Limit temperature range	-60 ... +100 °C
-------------------------	-----------------

Supus modificărilor.

WAGO Kontakttechnik GmbH & Co. KG  
 /Representative Office Romania  
 Sos. Pipera-Tunari nr. 1/1  
 building 1, 2nd floor | 077190 Voluntari, Ilfov  
 Tel.: +40-(0)31 421 85 68 | Email: info-RO@wago.com



Aveți întrebări despre produsele noastre?  
 Vă stăm la dispoziție pentru preluarea apelului la +40 (0) 31 421 85 68.

## Commercial data

Product Group	3 (Multi Conn. System)
Packaging type	BOX
Country of origin	PL
GTIN	4045454901127
Customs tariff number	85366990990

## Aprobări / certificate



### Country specific Approvals

Emblemă	Aprobare	Text de aprobare suplimentar	Nume certificat
	CSA DEKRA Certification B.V.	C22.2	1466354
	KEMA/KEUR DEKRA Certification B.V.	EN 61984	2190761.01

### Ship Approvals

Emblemă	Aprobare	Text de aprobare suplimentar	Nume certificat
	ABS American Bureau of Shipping	-	19- HG1869876- PDA

### UL-Approvals

Emblemă	Aprobare	Text de aprobare suplimentar	Nume certificat
	UR Underwriters Laboratories Inc.	UL 1059	E45172
	UR Underwriters Laboratories Inc.	UL 1977	20150318- E45171

Supus modificărilor.

WAGO Kontakttechnik GmbH & Co. KG  
/Representative Office Romania  
Sos. Pipera-Tunari nr. 1/1  
building 1, 2nd floor | 077190 Voluntari, Ilfov  
Tel.: +40-(0)31 421 85 68 | Email: info-RO@wago.com

Aveți întrebări despre produsele noastre?  
Vă stăm la dispoziție pentru preluarea apelului la +40 (0) 31 421 85 68.

## Counterpart



Nr. articol: 231-203/026-000

1-conductor female plug; 2.5 mm<sup>2</sup>; Pin spacing 7.5 mm; 3-pole; 2,50 mm<sup>2</sup>; gray

[www.wago.com/231-203/026-000](http://www.wago.com/231-203/026-000)

## Produse compatibile

### Marking accessories



Nr. articol: 210-833

Marking strips; on reel; 6 mm wide; plain; Self-adhesive; white

[www.wago.com/210-833](http://www.wago.com/210-833)



Nr. articol: 210-834

Marking strips; on reel; 5 mm wide; plain; Self-adhesive; white

[www.wago.com/210-834](http://www.wago.com/210-834)

### Coding



Nr. articol: 231-130

Coding key; snap-on type; light gray

[www.wago.com/231-130](http://www.wago.com/231-130)



Nr. articol: 231-500

Spacer; for formation of groups; light gray

[www.wago.com/231-500](http://www.wago.com/231-500)

## Descărcări

### Documentation

#### Additional Information

Technical explanations

Apr 3, 2019

pdf  
3,6 MB

Descărcare

### CAD/CAE-Data

#### CAD data

2D/3D Models 231-833/001-000/105-604

URL

Descărcare

## Installation Notes

### Coding

Supus modificărilor.



Coding a male header – fitting coding key(s).

## Familie de produse

*MCS* MIDI Classic

Afișare globală produse din familie.

Supus modificărilor.