

Fișă tehnică | Număr articol: 231-442/001-000/105-604/997-409

THR male header; 1.0 x 1.0 mm solder pin; angled; in tape-and-reel packaging; Pin spacing 5 mm; 12-pole; black

[www.wago.com/231-442/001-000/105-604/997-409](http://www.wago.com/231-442/001-000/105-604/997-409)

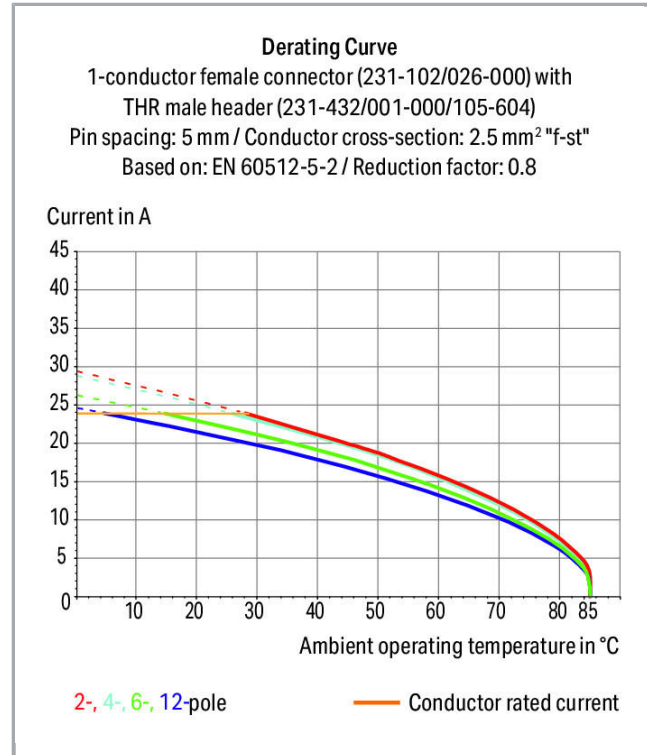
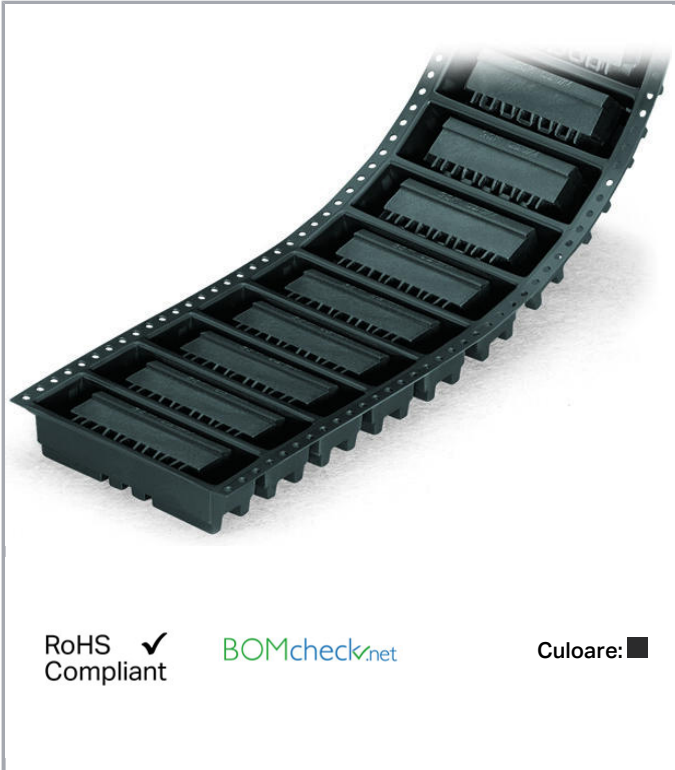

Supus modificărilor.

WAGO Kontakttechnik GmbH & Co. KG  
/Representative Office Romania  
Sos. Pipera-Tunari nr. 1/1  
building 1, 2nd floor | 077190 Voluntari, Ilfov  
Tel.: +40-(0)31 421 85 68 | Email: info-RO@wago.com

Aveți întrebări despre produsele noastre?  
Vă stăm la dispoziție pentru preluarea apelului la +40 (0) 31 421 85 68.

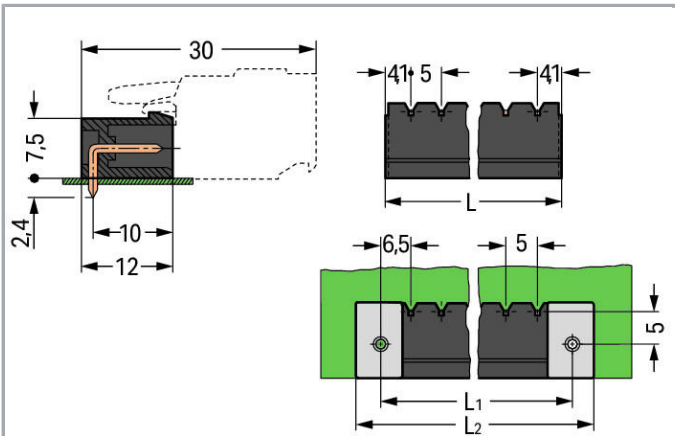

$$L = (\text{pole no.} - 1) \times \text{pin spacing} + 8.2 \text{ mm}$$

$$L_1 = L + 4.8 \text{ mm}$$

$$L_2 = L_1 + 7.2 \text{ mm}$$

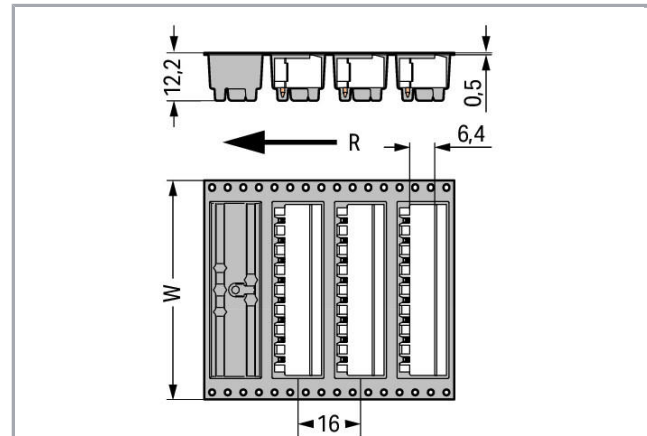

W= Tape width

R = Feed direction

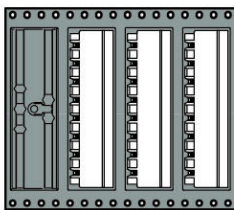

Position with even number of poles

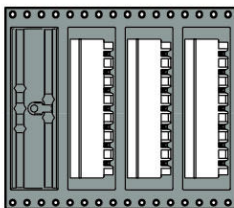

Position with odd number of poles

Pin position in tape-and-reel packaging

## Descriere articol

Supus modificărilor.

WAGO Kontakttechnik GmbH & Co. KG  
 /Representative Office Romania  
 Sos. Pipera-Tunari nr. 1/1  
 building 1, 2nd floor | 077190 Voluntari, Ilfov  
 Tel.: +40-(0)31 421 85 68 | Email: info-RO@wago.com

Aveți întrebări despre produsele noastre?  
 Vă stăm la dispoziție pentru preluarea apelului la +40 (0) 31 421 85 68.



- THR male headers for reflow soldering in SMT applications
- Available in tape-and-reel packaging for automated pick-and-place PCB assembly
- Also available in bulk packaging for manual placement
- Male headers may be mounted horizontally or vertically
- With coding fingers

**Safety information 1:**

The *MULTI CONNECTION SYSTEM (MCS)* is designed without breaking capacity for compliance with DIN EN 61984. When used as intended, MCS Connectors shall not be connected/disconnected when live or under load. The circuit design should ensure header pins, which can be touched, are not live when unmated.

**Date****Electrical data****Ratings per IEC/EN 60664-1**

| Ratings per                 | IEC/EN 60664-1  |
|-----------------------------|---|
| Nominal voltage (III/3)     | 320 V   |
| Rated surge voltage (III/3) | 4 kV  |
| Rated voltage (III/2)       | 320 V   |
| Rated surge voltage (III/2) | 4 kV  |
| Nominal voltage (II/2)      | 630 V   |
| Rated surge voltage (II/2)  | 4 kV  |
| Rated current               | 12 A  |
| Legend (ratings)            | (III / 2) $\hat{=}$ Overvoltage category III / Pollution degree 2 |

**Approvals per UL 1059**

|                                |         |
|--------------------------------|---------|
| Rated voltage UL (Use Group B) | 300 V   |
| Rated current UL (Use Group B) | 10 A    |
| Rated voltage UL (Use Group D) | 300 V   |
| Rated current UL (Use Group D) | 10 A    |
| Approvals per                  | UL 1059 |

**Approvals per UL 1977**

|                       |       |
|-----------------------|-------|
| Rated voltage UL 1977 | 600 V |
| Rated current UL 1977 | 10 A  |

Supus modificărilor.

WAGO Kontakttechnik GmbH & Co. KG  
 /Representative Office Romania  
 Sos. Pipera-Tunari nr. 1/1  
 building 1, 2nd floor | 077190 Voluntari, Ilfov  
 Tel.: +40-(0)31 421 85 68 | Email: info-RO@wago.com

Aveți întrebări despre produsele noastre?  
 Vă stăm la dispoziție pentru preluarea apelului la +40 (0) 31 421 85 68.



### Approvals per CSA

|                                 |       |
|---------------------------------|-------|
| Rated voltage CSA (Use Group B) | 300 V |
| Rated current CSA (Use Group B) | 10 A  |
| Rated voltage CSA (Use Group D) | 300 V |
| Rated current CSA (Use Group D) | 10 A  |

### Connection data

|                            |    |
|----------------------------|----|
| Pole No.                   | 12 |
| Total number of potentials | 12 |
| Number of connection types | 1  |
| Number of levels           | 1  |

### Geometrical Data

|  |                          |
|--|--------------------------|
| Pin spacing                              | 5 mm / 0.197 inch        |
| Width                                    | 63.2 mm / 2.488 inch     |
| Height                                   | 10.8 mm / 0.425 inch     |
| Height from the surface                  | 8.4 mm / 0.331 inch      |
| Depth                                    | 12 mm / 0.472 inch       |
| Solder pin length                        | 2,4 mm                   |
| Solder pin dimensions                    | 1 x 1 mm                 |
| Plated through-hole diameter (THR)       | 1.4 <sup>(+0.1)</sup> mm |
| Reel diameter of tape-and-reel packaging | 330 mm                   |
| Tape width                               | 88 mm                    |

### Plug connection

|                                    |                     |
|------------------------------------|---------------------|
| Contact type (pluggable connector) | Male connector/plug |
| Connector (connection type)        | for PCBs            |
| Mismating protection               | No                  |
| Mating direction to the PCB        | 0°                  |

### PCB contact

|                                     |   |
|-------------------------------------|---|
| PCB contact                         | THR                                     |
| Solder pin arrangement              | over the entire male connector, in line |
| Number of solder pins per potential | 1                                       |

Supus modificărilor.

WAGO Kontakttechnik GmbH & Co. KG  
 /Representative Office Romania  
 Sos. Pipera-Tunari nr. 1/1  
 building 1, 2nd floor | 077190 Voluntari, Ilfov  
 Tel.: +40-(0)31 421 85 68 | Email: info-RO@wago.com

Aveți întrebări despre produsele noastre?  
 Vă stăm la dispoziție pentru preluarea apelului la +40 (0) 31 421 85 68.

## Material Data

|                             |  |
|-----------------------------|--|
| Color                       | black                                  |
| Material group              | I                                      |
| Insulation material         | Polyphthalamide (PPA GF)               |
| Flammability class per UL94 | V0                                     |
| Contact material            | Electrolytic copper (E <sub>Cu</sub> ) |
| Contact plating             | tin-plated                             |
| Fire load                   | 0,084 MJ                               |
| Weight                      | 4,4 g                                  |

## Environmental Requirements

|                         |                 |
|-------------------------|-----------------|
| Limit temperature range | -60 ... +100 °C |
|-------------------------|-----------------|

## Commercial data

|                       |                        |
|-----------------------|------------------------|
| Product Group         | 3 (Multi Conn. System) |
| Packaging type        | bag                    |
| Country of origin     | DE                     |
| GTIN                  | 4044918936552          |
| Customs tariff number | 85366990990            |

## Aprobări / certificate

### Country specific Approvals

| Emblemă  | Aprobare                        | Text de aprobare suplimentar | Nume certificat |
|--|---------------------------------|------------------------------|-----------------|
|  | CSA<br>DEKRA Certification B.V. | C22.2                        | 1466354         |

## Counterpart



Nr. articol 231-112/026-000

1-conductor female plug; 2.5 mm<sup>2</sup>; Pin spacing 5 mm; 12-pole; 2,50 mm<sup>2</sup>; gray

[www.wago.com/231-112/026-000](http://www.wago.com/231-112/026-000)

Supus modificărilor.

WAGO Kontakttechnik GmbH & Co. KG  
/Representative Office Romania  
Sos. Pipera-Tunari nr. 1/1  
building 1, 2nd floor | 077190 Voluntari, Ilfov  
Tel.: +40-(0)31 421 85 68 | Email: info-RO@wago.com

Aveți întrebări despre produsele noastre?  
Vă stăm la dispoziție pentru preluarea apelului la +40 (0) 31 421 85 68.

## Produse compatibile

### Coding



Nr. articol: 231-129

Coding key; snap-on type; light gray

[www.wago.com/231-129](http://www.wago.com/231-129)



Nr. articol: 231-500

Spacer; for formation of groups; light gray

[www.wago.com/231-500](http://www.wago.com/231-500)

### Marking accessories



Nr. articol: 210-833

Marking strips; on reel; 6 mm wide; plain; Self-adhesive; white

[www.wago.com/210-833](http://www.wago.com/210-833)



Nr. articol: 210-834

Marking strips; on reel; 5 mm wide; plain; Self-adhesive; white

[www.wago.com/210-834](http://www.wago.com/210-834)

## Descărcări

### CAD/CAE-Data

#### CAE data

EPLAN Data Portal 231-442/001-000/105-604/997-409

URL

Descărcare

## Installation Notes

### Coding

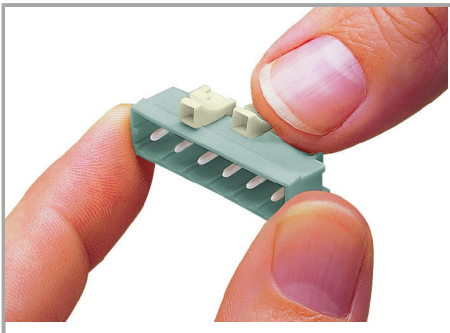

Coding a male header – fitting coding key(s).

## Familie de produse

<i>MCS</i> MIDI Classic

Afișare globală produse din familie.

Supus modificărilor.

WAGO Kontakttechnik GmbH & Co. KG  
/Representative Office Romania  
Sos. Pipera-Tunari nr. 1/1  
building 1, 2nd floor | 077190 Voluntari, Ilfov  
Tel.: +40-(0)31 421 85 68 | Email: info-RO@wago.com

Aveți întrebări despre produsele noastre?

Vă stăm la dispoziție pentru preluarea apelului la +40 (0) 31 421 85 68.