

## Fișă tehnică | Număr articol: 771-9973/106-601

pre-assembled connecting cable; Eca; Socket/open-ended; 3-pole; Cod. P;  
H05VV-F 3G 1.5 mm<sup>2</sup>; 6 m; 1,50 mm<sup>2</sup>; red

[www.wago.com/771-9973/106-601](http://www.wago.com/771-9973/106-601)

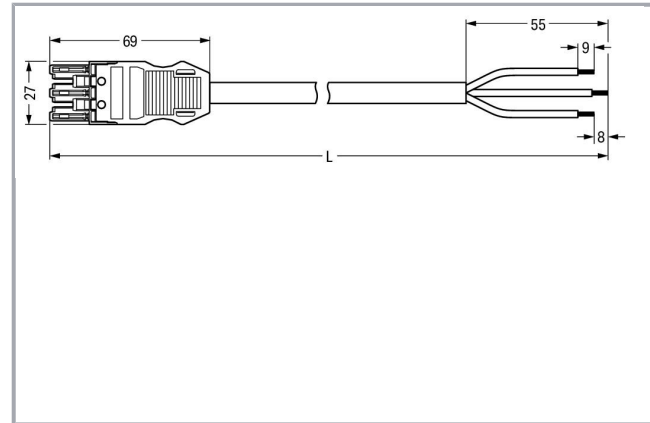
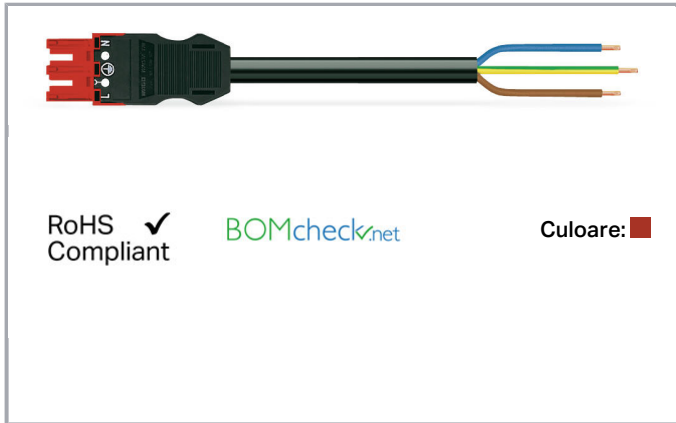

### Descriere articol

- Protected against mismatching and maintenance-free

### Note:

Cables with a different fire class can be found in the eShop.

### Note on mismatching protection:

All WINSTA<sup>®</sup> components are 100% protected against mismatching when:

- plugging different numbers of poles
- plugging while rotated 180
- plugging while laterally staggered
- plugging one pole

### Safety information 1:

Application note for the U.S. market (USR): Some versions may also be used for current interruption in accordance with the UL certificate in select applications with currents below 16 A and voltages up to 600 V. For further information, please contact your local sales office.

### Date

### Electrical data

Note on Contact Resistance

approx. 1 mΩ of contact resistance approx. 0.25 mΩ contact transition plug/socket

Supus modificărilor.

WAGO Kontakttechnik GmbH & Co. KG  
/Representative Office Romania  
Sos. Pipera-Tunari nr. 1/1  
building 1, 2nd floor | 077190 Voluntari, Ilfov  
Tel.: +40-(0)31 421 85 68 | Email: info-RO@wago.com

Aveți întrebări despre produsele noastre?  
Vă stăm la dispoziție pentru preluarea apelului la +40 (0) 31 421 85 68.



### Ratings per IEC/EN 60664-1

Ratings per	IEC/EN 60664-1
Nominal voltage (III/3)	250 V
Rated surge voltage (III/3)	4 kV
Rated current	16 A
Legend (ratings)	(III / 3) $\triangleq$ Overvoltage category III / Pollution degree 3

### Approvals per UL 1977

Rated voltage UL 1977	600 V
Rated current UL 1977	23 A

### Connection data

Strip length	9 mm / 0.35 inch
Pole No.	3
Total number of potentials	3
Ground function	with preceding ground contact
Conductor preparation	tip-bonded
Sheathed cable diameter	7,4 ... 9,4 mm
Wire cross-section	1,5 mm <sup>2</sup>
Strip length (outer insulation)	55 mm
Connection type	Socket - Free end

### Geometrical Data

Pin spacing	10 mm / 0.394 inch
Total length	6 m

### Mechanical data

Coding	P
Mating force of a plug-in connection	approx. 20 ... 70 N (depending on pole number)
Retention force of a plug-in connection	when locked: > 80N
Unmating force of a plug-in connection	when unlocked: approx. 20 ... 70 N (depending on pole number)
Number of mating cycles	200 (without resistive load) 100 (with resistive load $I_N = 25$ A), tested (4 mm <sup>2</sup> )
Connection type	Socket - free end
Type of pre-assembled cable	Connecting cable

Supus modificărilor.

WAGO Kontakttechnik GmbH & Co. KG  
 /Representative Office Romania  
 Sos. Pipera-Tunari nr. 1/1  
 building 1, 2nd floor | 077190 Voluntari, Ilfov  
 Tel.: +40-(0)31 421 85 68 | Email: info-RO@wago.com

Aveți întrebări despre produsele noastre?  
 Vă stăm la dispoziție pentru preluarea apelului la +40 (0) 31 421 85 68.



Cable type	H05VV-F 3G1.5
Marking	L N
Protection type	IP20
Note on protection type	Only when mated (these compact connectors are not designed for use in open, easily accessible areas).
Potential marking	L N
Application	Computer applications (UPS)

### Plug connection

Mismatching protection	Yes
Locking of plug-in connection	locking lever
Locking lever	retrofitable

### Material Data

Color	red
Insulation material	Polyamide 66 (PA 66)
Fire class per EN 50575	E <sub>ca</sub>
Contact material	Copper or copper alloy (surface-treated)
Fire load	11,682 MJ
Connector color	red
Printing color of mating face	white
Strain relief color	black
Printing color of strain relief	white
Sheathed cable color	black
Printing color of sheathed cable	white
Sheath material	PVC
Weight	648,8 g

### Environmental Requirements

Processing temperature	-5 ... +40 °C
Continuous operating temperature	-35 ... +85 °C
Note on continuous operating temperature	PVC cable for temperatures ≤ 70 °C (including halogen-free) Insulating parts for temperatures ≤ 105 °C

### Commercial data

Packaging type	not packed
Country of origin	DE

Supus modificărilor.



WAGO Kontakttechnik GmbH & Co. KG  
/Representative Office Romania  
Sos. Pipera-Tunari nr. 1/1  
building 1, 2nd floor | 077190 Voluntari, Ilfov  
Tel.: +40-(0)31 421 85 68 | Email: info-RO@wago.com

Aveți întrebări despre produsele noastre?  
Vă stăm la dispoziție pentru preluarea apelului la +40 (0) 31 421 85 68.

GTIN	4045454403096
Customs tariff number	85444290900

## Aprobări / certificate



### Country specific Approvals

Emblemă	Aprobare	Text de aprobare suplimentar	Nume certificat
	<b>CCA</b> DEKRA Certification B.V.	EN 61535	NTR NL-7355
	<b>KEMA/KEUR</b> DEKRA Certification B.V.	EN 61535	2179129.01

## Counterpart

## Produse compatibile

### Marking accessories

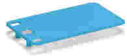
	<b>Nr. articol: 210-334</b> Marking strips; as a DIN A4 sheet; Strip width 5 mm; Strip length 182 mm; plain; Self-adhesive; white	<a href="http://www.wago.com/210-334">www.wago.com/210-334</a>
	<b>Nr. articol: 770-450</b> Marker card; Plastic; white	<a href="http://www.wago.com/770-450">www.wago.com/770-450</a>
	<b>Nr. articol: 770-450/000-001</b> Marker card; Plastic; white	<a href="http://www.wago.com/770-450/000-001">www.wago.com/770-450/000-001</a>
	<b>Nr. articol: 770-450/000-002</b> Marker card; Plastic; white	<a href="http://www.wago.com/770-450/000-002">www.wago.com/770-450/000-002</a>
	<b>Nr. articol: 770-450/000-005</b> Marker card; Plastic; white	<a href="http://www.wago.com/770-450/000-005">www.wago.com/770-450/000-005</a>
	<b>Nr. articol: 770-450/000-006</b> Marker card; Plastic; white	<a href="http://www.wago.com/770-450/000-006">www.wago.com/770-450/000-006</a>

Supus modificărilor.

WAGO Kontakttechnik GmbH & Co. KG  
/Representative Office Romania  
Sos. Pipera-Tunari nr. 1/1  
building 1, 2nd floor | 077190 Voluntari, Ilfov  
Tel.: +40-(0)31 421 85 68 | Email: info-RO@wago.com

Aveți întrebări despre produsele noastre?  
Vă stăm la dispoziție pentru preluarea apelului la +40 (0) 31 421 85 68.



Nr. articol: 770-450/000-012  
Marker card; Plastic; white

[www.wago.com/770-450/000-012](http://www.wago.com/770-450/000-012)

---

protection



Nr. articol: 770-201  
Lockout cap; 12-pole, separable; 12-pole; for sockets; black

[www.wago.com/770-201](http://www.wago.com/770-201)



Nr. articol: 770-221  
Lockout cap; for socket; 12-pole; separable; white

[www.wago.com/770-221](http://www.wago.com/770-221)

---

Descărcări

CAD/CAE-Data

CAE data

WSCAD Universe 771-9973/106-601

URL

Descărcare

---

Installation Notes

Familie de produse

<i>WINSTA</i>® MIDI

Afișare globală produse din familie.

Supus modificărilor.

---

WAGO Kontakttechnik GmbH & Co. KG  
/Representative Office Romania  
Sos. Pipera-Tunari nr. 1/1  
building 1, 2nd floor | 077190 Voluntari, Ilfov  
Tel.: +40-(0)31 421 85 68 | Email: info-RO@wago.com

Aveți întrebări despre produsele noastre?  
Vă stăm la dispoziție pentru preluarea apelului la +40 (0) 31 421 85 68.