

Fișă tehnică | Număr articol: 873-902

Luminaire disconnect connector; 2-pole; 4,00 mm²; yellow

www.wago.com/873-902

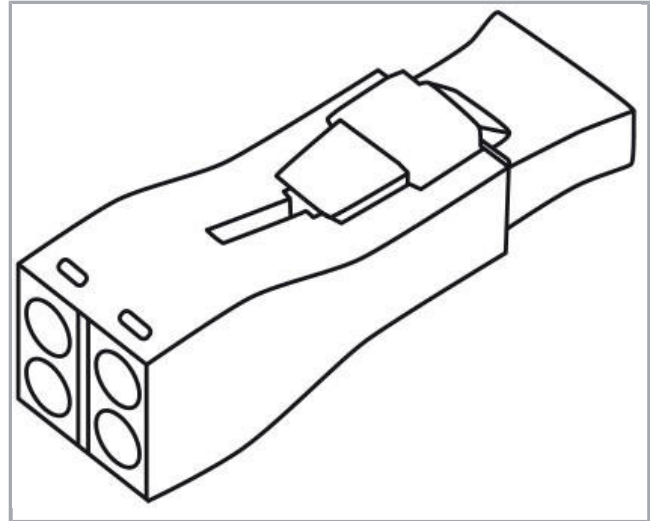

Date

Electrical data

Ratings per IEC/EN 60664-1

Ratings per	EN 60998
Nominal voltage (II/2)	400 V
Rated surge voltage (II/2)	4 kV
Rated current	6 A
Ratings per	EN 61984

Connection data

Connection type (1)	Plug
Connection technology	PUSH WIRE®

Supus modificărilor.

WAGO Kontakttechnik GmbH & Co. KG
/Representative Office Romania
Sos. Pipera-Tunari nr. 1/1
building 1, 2nd floor | 077190 Voluntari, Ilfov
Tel.: +40-(0)31 421 85 68 | Email: info-RO@wago.com

Aveți întrebări despre produsele noastre?
Vă stăm la dispoziție pentru preluarea apelului la +40 (0) 31 421 85 68.



Actuation type	Push-in
Connectable conductor materials	Copper
Solid conductor	0,75 ... 4 mm ² / 18 ... 12 AWG
Stranded conductor	1,5 ... 2,5 mm ² / 16 ... 12 AWG
Strip length	11 ... 13 mm / 0.43 ... 0.51 inch
Pole No.	2
Connection type 2	Socket
Solid conductor 2	0,75 mm ² / 18 AWG
Strip length 2	9 ... 11 mm / 0.35 ... 0.43 inch
Total number of connection points	6
Total number of potentials	2

Geometrical Data

Width	13 mm / 0.512 inch
Height	13,2 mm / 0.52 inch
Depth	42 mm / 1.654 inch

Material Data

Color	yellow
Fire load	0,103 MJ
Weight	4,8g

Commercial data

Product Group	8 (Misc. Chassis Mount Blocks)
Packaging type	BOX
Country of origin	CN
GTIN	4045454548421
Customs tariff number	85366990990

Aprobări / certificate





Country specific Approvals

Emblemă	Aprobare	Text de aprobare suplimentar	Nume certificat
	CCA DEKRA Certification B.V.	EN 61984	2178521.01

Supus modificărilor.

WAGO Kontakttechnik GmbH & Co. KG
/Representative Office Romania
Sos. Pipera-Tunari nr. 1/1
building 1, 2nd floor | 077190 Voluntari, Ilfov
Tel.: +40-(0)31 421 85 68 | Email: info-RO@wago.com

Aveți întrebări despre produsele noastre?
Vă stăm la dispoziție pentru preluarea apelului la +40 (0) 31 421 85 68.

	CCA DEKRA Certification B.V.	EN 61984	NTR NL-7390
	CCA DEKRA Certification B.V.	EN 60998	NTR NL-7391
	CCA DEKRA Certification B.V.	EN 60998	2178521.02
	CSA DEKRA Certification B.V.	C22.2 No. 182.3	154112 (LR 18677)

UL-Approvals

Emblemă	Aprobare	Text de aprobare suplimentar	Nume certificat
	UL UL International Germany GmbH	UL 2459	E313353

Counterpart

Descărcări

Documentation

Additional Information

Technical explanations	Apr 3, 2019	pdf 2,1 MB	Descărcare
------------------------	-------------	---------------	------------

CAD/CAE-Data

CAD data

2D/3D Models 873-902	URL	Descărcare
----------------------	-----	------------

Supus modificărilor.



Installation Notes

Supus modificărilor.

WAGO Kontakttechnik GmbH & Co. KG
/Representative Office Romania
Sos. Pipera-Tunari nr. 1/1
building 1, 2nd floor | 077190 Voluntari, Ilfov
Tel.: +40-(0)31 421 85 68 | Email: info-RO@wago.com

Aveți întrebări despre produsele noastre?
Vă stăm la dispoziție pentru preluarea apelului la +40 (0) 31 421 85 68.