

## Fișă tehnică | Număr articol: 2002-3231

Triple-deck terminal block; Through/through/through terminal block; L/L/L; with marker carrier; suitable for Ex e II applications; for DIN-rail 35 x 15 and 35 x 7.5; 2.5 mm<sup>2</sup>; Push-in CAGE CLAMP®; 2,50 mm<sup>2</sup>; gray

[www.wago.com/2002-3231](http://www.wago.com/2002-3231)

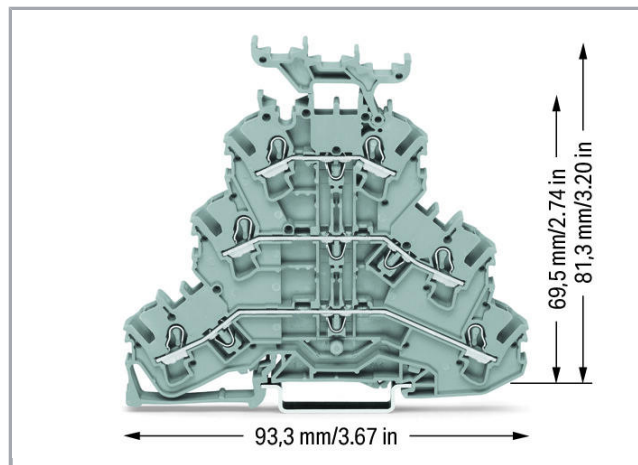
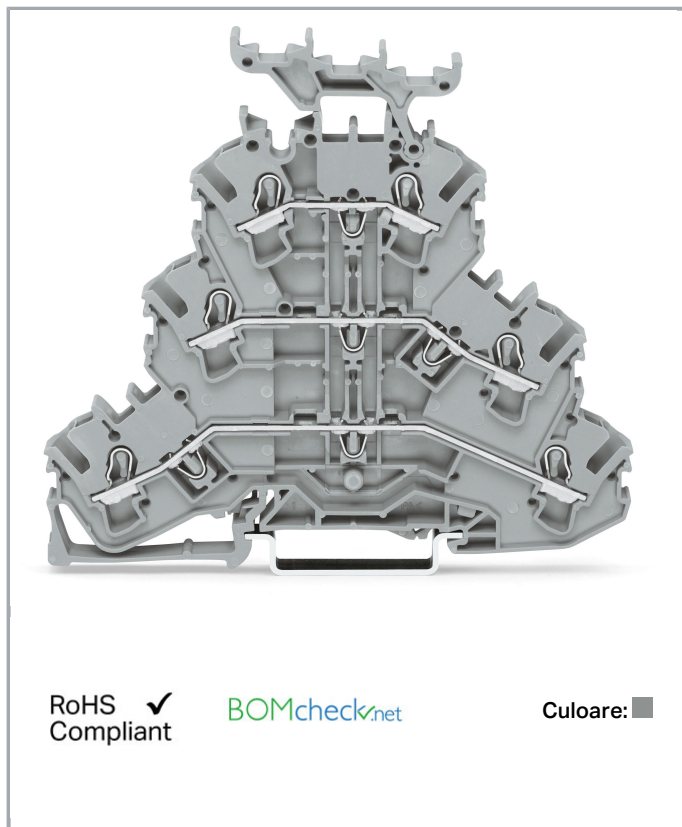

Supus modificărilor.

WAGO Kontakttechnik GmbH & Co. KG  
/Representative Office Romania  
Sos. Pipera-Tunari nr. 1/1  
building 1, 2nd floor | 077190 Voluntari, Ilfov  
Tel.: +40-(0)31 421 85 68 | Email: info-RO@wago.com

Aveți întrebări despre produsele noastre?  
Vă stăm la dispoziție pentru preluarea apelului la +40 (0) 31 421 85 68.

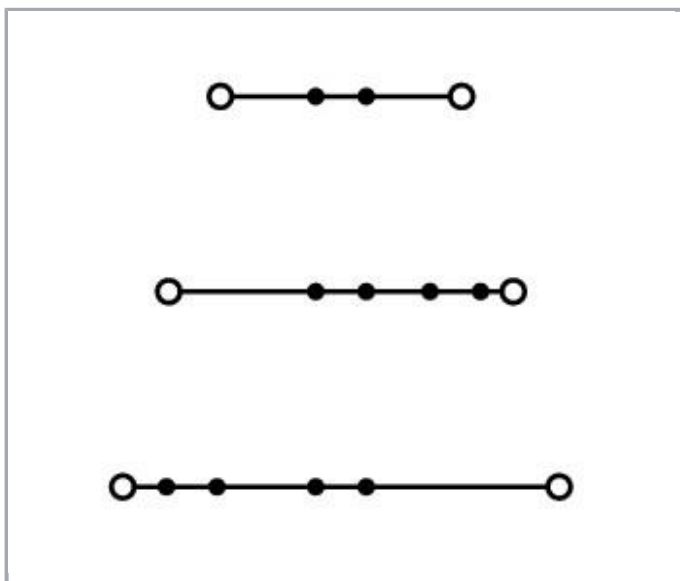
**Date****Electrical data****Ratings per IEC/EN 60664-1**

Ratings per	IEC/EN 60947-7-1
Nominal voltage (III/3)	500 V
Rated surge voltage (III/3)	6 kV
Rated current	24 A
Rated current 2	28 A
Legend (ratings)	(III / 3) ≙ Overvoltage category III / Pollution degree 3

**Approvals per UL 1059**

Rated voltage UL (Use Group B)	300 V
Rated current UL (Use Group B)	20 A
Rated voltage UL (Use Group C)	300 V
Rated current UL (Use Group C)	20 A
Rated voltage UL (Use Group D)	600 V
Rated current UL (Use Group D)	5 A
Approvals per	UL 1059

**Approvals per CSA**

Rated voltage CSA (Use Group B)	600 V
---------------------------------	-------

Supus modificărilor.



Rated current CSA (Use Group B)	20 A
Rated voltage CSA (Use Group C)	600 V
Rated current CSA (Use Group C)	20 A

### Approvals Ex

Rated voltage EN (Ex e II)	440 V
Rated current (Ex e II)	19 A
Rated current (Ex e II) with jumper	17 A

### Connection data

Connection technology	Push-in CAGE CLAMP®
Number of connection points (connection type)	3
Actuation type	Push-in Open Tool Slot
Connectable conductor materials	Copper
Nominal cross-section	2,5 mm <sup>2</sup>
Solid conductor	0,25 ... 4 mm <sup>2</sup> / 22 ... 12 AWG
Solid conductor; push-in termination	0,75 ... 4 mm <sup>2</sup> / 18 ... 12 AWG
Fine-stranded conductor	0,25 ... 4 mm <sup>2</sup> / 22 ... 12 AWG
Fine-stranded conductor; with insulated ferrule	1 ... 2,5 mm <sup>2</sup> / 18 ... 12 AWG
Fine-stranded conductor; with ferrule; push-in termination	1 ... 2,5 mm <sup>2</sup> / 18 ... 12 AWG
Strip length	10 ... 12 mm / 0.39 ... 0.47 inch
Number of connection points	3
Total number of connection points	6
Total number of potentials	3
Number of levels	3
Wiring type	Front-entry wiring
Note (conductor cross-section)	Depending on the conductor characteristic, a conductor with a smaller cross-section can also be inserted via push-in termination.

### Geometrical Data

Width	5,2 mm / 0.205 inch
Height from upper-edge of DIN-rail	81,3 mm / 3.201 inch
Depth	93,3 mm / 3.673 inch

### Mechanical data

Design	horizontal type
--------	-----------------

Supus modificărilor.

WAGO Kontakttechnik GmbH & Co. KG  
/Representative Office Romania  
Sos. Pipera-Tunari nr. 1/1  
building 1, 2nd floor | 077190 Voluntari, Ilfov  
Tel.: +40-(0)31 421 85 68 | Email: info-RO@wago.com

Aveți întrebări despre produsele noastre?  
Vă stăm la dispoziție pentru preluarea apelului la +40 (0) 31 421 85 68.

Mounting type	DIN-35 rail
Potential marking	L/L/L
Marking level	Center/side marking

### Material Data



Color	gray
Insulation material	Polyamide 66 (PA 66)
Fire load	0,336 MJ
Weight	17,5 g

### Commercial data

Product Group	22 (TOPJOB S)
Packaging type	BOX
Country of origin	DE
GTIN	4044918989756
Customs tariff number	85369010000

### Aprobări / certificate

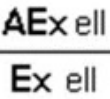
#### Ex-Approvals

Emblemă	Aprobare	Text de aprobare suplimentar	Nume certificat
	<b>AEx</b> Underwriters Laboratories Inc.	UL 60079	20190704-E185892
	<b>ATEX</b> Physikalisch Technische Bundesanstalt (PTB)	EN 60079	PTB 03 ATEX 1162 U (II 2 G/D Ex e II bzw. I M 2 Ex e I)

#### Country specific Approvals

Emblemă	Aprobare	Text de aprobare suplimentar	Nume certificat
	<b>CCA</b> DEKRA Certification B.V.	EN 60947	NTR NL 7730
	<b>CSA</b>	C22.2 No. 158	1536069

Supus modificărilor.

WAGO Kontakttechnik GmbH & Co. KG  
 /Representative Office Romania  
 Sos. Pipera-Tunari nr. 1/1  
 building 1, 2nd floor | 077190 Voluntari, Ilfov  
 Tel.: +40-(0)31 421 85 68 | Email: info-RO@wago.com

Aveți întrebări despre produsele noastre?  
 Vă stăm la dispoziție pentru preluarea apelului la +40 (0) 31 421 85 68.





DEKRA Certification B.V.

KEMA/KEUR  
DEKRA Certification B.V.

EN 60947

71-  
107687

## Ship Approvals

Emblemă	Aprobare	Text de aprobare suplimentar	Nume certificat
	<b>ABS</b> American Bureau of Shipping	EN 60947	20- HG1941090- PDA
	<b>BV</b> Bureau Veritas S.A.	EN 60947	38586/A0 BV
	<b>DNV GL</b> Det Norske Veritas, Germanischer Lloyd	-	TAE00001V2

## UL-Approvals

Emblemă	Aprobare	Text de aprobare suplimentar	Nume certificat
	<b>cURus</b> Underwriters Laboratories Inc.	UL 1059	E45172

## Counterpart

## Produse compatibile

Supus modificărilor.

WAGO Kontakttechnik GmbH & Co. KG  
/Representative Office Romania  
Sos. Pipera-Tunari nr. 1/1  
building 1, 2nd floor | 077190 Voluntari, Ilfov  
Tel.: +40-(0)31 421 85 68 | Email: info-RO@wago.com

Aveți întrebări despre produsele noastre?  
Vă stăm la dispoziție pentru preluarea apelului la +40 (0) 31 421 85 68.

## Protective Warning Marker

**Nr. articol: 2002-115**

Protective warning marker; with high-voltage symbol, black; for 5 terminal blocks; yellow

[www.wago.com/2002-115](http://www.wago.com/2002-115)

## Carrier rail

**Nr. articol: 210-112**

Steel carrier rail; 35 x 7.5 mm; 1 mm thick; 2 m long; slotted; according to EN 60715; Hole width 25 mm

[www.wago.com/210-112](http://www.wago.com/210-112)**Nr. articol: 210-113**

Steel carrier rail; 35 x 7.5 mm; 1 mm thick; 2 m long; unslotted; according to EN 60715

[www.wago.com/210-113](http://www.wago.com/210-113)**Nr. articol: 210-114**

Steel carrier rail; 35 x 15 mm; 1.5 mm thick; 2 m long; unslotted; similar to EN 60715

[www.wago.com/210-114](http://www.wago.com/210-114)**Nr. articol: 210-115**

Steel carrier rail; 35 x 7.5 mm; 1 mm thick; 2 m long; slotted; according to EN 60715; Hole width 18 mm

[www.wago.com/210-115](http://www.wago.com/210-115)**Nr. articol: 210-118**

Steel carrier rail; 35 x 15 mm; 2.3 mm thick; 2 m long; unslotted; according to EN 60715

[www.wago.com/210-118](http://www.wago.com/210-118)**Nr. articol: 210-196**

Aluminum carrier rail; 35 x 8.2 mm; 1.6 mm thick; 2 m long; unslotted; similar to EN 60715; silver-colored

[www.wago.com/210-196](http://www.wago.com/210-196)**Nr. articol: 210-197**

Steel carrier rail; 35 x 15 mm; 1.5 mm thick; 2 m long; slotted; similar to EN 60715

[www.wago.com/210-197](http://www.wago.com/210-197)**Nr. articol: 210-198**

Copper carrier rail; 35 x 15 mm; 2.3 mm thick; 2 m long; unslotted; according to EN 60715; copper-colored

[www.wago.com/210-198](http://www.wago.com/210-198)**Nr. articol: 210-504**

Steel carrier rail; 35 x 7.5 mm; 1 mm thick; 2 m long; slotted; galvanized; according to EN 60715

[www.wago.com/210-504](http://www.wago.com/210-504)**Nr. articol: 210-505**

Steel carrier rail; 35 x 7.5 mm; 1 mm thick; 2 m long; unslotted; galvanized; according to EN 60715

[www.wago.com/210-505](http://www.wago.com/210-505)**Nr. articol: 210-506**

Steel carrier rail; 35 x 15 mm; 1.5 mm thick; 2 m long; unslotted; galvanized; similar to EN 60715

[www.wago.com/210-506](http://www.wago.com/210-506)**Nr. articol: 210-508**

Steel carrier rail; 35 x 15 mm; 1.5 mm thick; 2 m long; slotted; galvanized; similar to EN 60715

[www.wago.com/210-508](http://www.wago.com/210-508)

## Marking accessories

**Nr. articol: 2002-161**















Adaptor

[www.wago.com/2002-161](http://www.wago.com/2002-161)**Nr. articol: 2009-110**

Marking strips; on reel; not stretchable; plain; snap-on type; white

[www.wago.com/2009-110](http://www.wago.com/2009-110)















Supus modificărilor.

	<b>Nr. articol: 2009-115</b> WMB-Inline; for Smart Printer; 1500 pieces on roll; stretchable 5 - 5.2 mm; plain; snap-on type; white	<a href="http://www.wago.com/2009-115">www.wago.com/2009-115</a>
	<b>Nr. articol: 2009-115/000-002</b> WMB-Inline; for Smart Printer; 1500 pieces on roll; stretchable 5 - 5.2 mm; plain; snap-on type; yellow	<a href="http://www.wago.com/2009-115/000-002">www.wago.com/2009-115/000-002</a>
	<b>Nr. articol: 2009-115/000-005</b> WMB-Inline; for Smart Printer; 1500 pieces on roll; stretchable 5 - 5.2 mm; plain; snap-on type; red	<a href="http://www.wago.com/2009-115/000-005">www.wago.com/2009-115/000-005</a>
	<b>Nr. articol: 2009-115/000-006</b> WMB-Inline; for Smart Printer; 1500 pieces on roll; stretchable 5 - 5.2 mm; plain; snap-on type; blue	<a href="http://www.wago.com/2009-115/000-006">www.wago.com/2009-115/000-006</a>
	<b>Nr. articol: 2009-115/000-007</b> WMB-Inline; for Smart Printer; 1500 pieces on roll; stretchable 5 - 5.2 mm; plain; snap-on type; gray	<a href="http://www.wago.com/2009-115/000-007">www.wago.com/2009-115/000-007</a>
	<b>Nr. articol: 2009-115/000-012</b> WMB-Inline; for Smart Printer; 1500 pieces on roll; stretchable 5 - 5.2 mm; plain; snap-on type; orange	<a href="http://www.wago.com/2009-115/000-012">www.wago.com/2009-115/000-012</a>
	<b>Nr. articol: 2009-115/000-017</b> WMB-Inline; for Smart Printer; 1500 pieces on roll; stretchable 5 - 5.2 mm; plain; snap-on type; light green	<a href="http://www.wago.com/2009-115/000-017">www.wago.com/2009-115/000-017</a>
	<b>Nr. articol: 2009-115/000-023</b> WMB-Inline; for Smart Printer; 1500 pieces on roll; stretchable 5 - 5.2 mm; plain; snap-on type; green	<a href="http://www.wago.com/2009-115/000-023">www.wago.com/2009-115/000-023</a>
	<b>Nr. articol: 2009-115/000-024</b> WMB-Inline; for Smart Printer; 1500 pieces on roll; stretchable 5 - 5.2 mm; plain; snap-on type; violet	<a href="http://www.wago.com/2009-115/000-024">www.wago.com/2009-115/000-024</a>
	<b>Nr. articol: 2009-145</b> Mini-WSB Inline; for Smart Printer; 1700 pieces on roll; stretchable 5 - 5.2 mm; plain; snap-on type; white	<a href="http://www.wago.com/2009-145">www.wago.com/2009-145</a>
	<b>Nr. articol: 2009-145/000-002</b> Mini-WSB Inline; for Smart Printer; 1700 pieces on roll; stretchable 5 - 5.2 mm; plain; snap-on type; yellow	<a href="http://www.wago.com/2009-145/000-002">www.wago.com/2009-145/000-002</a>
	<b>Nr. articol: 2009-145/000-005</b> Mini-WSB Inline; for Smart Printer; 1700 pieces on roll; stretchable 5 - 5.2 mm; plain; snap-on type; red	<a href="http://www.wago.com/2009-145/000-005">www.wago.com/2009-145/000-005</a>
	<b>Nr. articol: 2009-145/000-006</b> Mini-WSB Inline; for Smart Printer; 1700 pieces on roll; stretchable 5 - 5.2 mm; plain; snap-on type; blue	<a href="http://www.wago.com/2009-145/000-006">www.wago.com/2009-145/000-006</a>
	<b>Nr. articol: 2009-145/000-007</b> Mini-WSB Inline; for Smart Printer; 1700 pieces on roll; stretchable 5 - 5.2 mm; plain; snap-on type; gray	<a href="http://www.wago.com/2009-145/000-007">www.wago.com/2009-145/000-007</a>

Supus modificărilor.

WAGO Kontakttechnik GmbH & Co. KG  
/Representative Office Romania  
Sos. Pipera-Tunari nr. 1/1  
building 1, 2nd floor | 077190 Voluntari, Ilfov  
Tel.: +40-(0)31 421 85 68 | Email: info-RO@wago.com

Aveți întrebări despre produsele noastre?  
Vă stăm la dispoziție pentru preluarea apelului la +40 (0) 31 421 85 68.

	<b>Nr. articol: 2009-145/000-012</b> Mini-WSB Inline; for Smart Printer; 1700 pieces on roll; stretchable 5 - 5.2 mm; plain; snap-on type; orange	<a href="http://www.wago.com/2009-145/000-012">www.wago.com/2009-145/000-012</a>
	<b>Nr. articol: 2009-145/000-023</b> Mini-WSB Inline; for Smart Printer; 1700 pieces on roll; stretchable 5 - 5.2 mm; plain; snap-on type; green	<a href="http://www.wago.com/2009-145/000-023">www.wago.com/2009-145/000-023</a>
	<b>Nr. articol: 2009-145/000-024</b> Mini-WSB Inline; for Smart Printer; 1700 pieces on roll; stretchable 5 - 5.2 mm; plain; snap-on type; violet	<a href="http://www.wago.com/2009-145/000-024">www.wago.com/2009-145/000-024</a>
	<b>Nr. articol: 2009-191</b> Group marker carrier	<a href="http://www.wago.com/2009-191">www.wago.com/2009-191</a>
	<b>Nr. articol: 2009-192</b> Group marker carrier	<a href="http://www.wago.com/2009-192">www.wago.com/2009-192</a>
	<b>Nr. articol: 2009-193</b> Group marker carrier	<a href="http://www.wago.com/2009-193">www.wago.com/2009-193</a>
	<b>Nr. articol: 2009-198</b> Adaptor	<a href="http://www.wago.com/2009-198">www.wago.com/2009-198</a>
	<b>Nr. articol: 248-501</b> Miniature WSB Quick marking system; plain; Marker width 5 mm; 10 strips with 10 markers per card	<a href="http://www.wago.com/248-501">www.wago.com/248-501</a>
	<b>Nr. articol: 248-501/000-002</b> Mini-WSB marking card; as card; not stretchable; plain; snap-on type; yellow	<a href="http://www.wago.com/248-501/000-002">www.wago.com/248-501/000-002</a>
	<b>Nr. articol: 248-501/000-005</b> Mini-WSB marking card; as card; not stretchable; plain; snap-on type; red	<a href="http://www.wago.com/248-501/000-005">www.wago.com/248-501/000-005</a>
	<b>Nr. articol: 248-501/000-006</b> Mini-WSB marking card; as card; not stretchable; plain; snap-on type; blue	<a href="http://www.wago.com/248-501/000-006">www.wago.com/248-501/000-006</a>
	<b>Nr. articol: 248-501/000-007</b> Mini-WSB marking card; as card; not stretchable; plain; snap-on type; gray	<a href="http://www.wago.com/248-501/000-007">www.wago.com/248-501/000-007</a>
	<b>Nr. articol: 248-501/000-012</b> Mini-WSB marking card; as card; not stretchable; plain; snap-on type; orange	<a href="http://www.wago.com/248-501/000-012">www.wago.com/248-501/000-012</a>
	<b>Nr. articol: 248-501/000-017</b> Mini-WSB marking card; as card; not stretchable; plain; snap-on type; light green	<a href="http://www.wago.com/248-501/000-017">www.wago.com/248-501/000-017</a>
	<b>Nr. articol: 248-501/000-023</b> Mini-WSB marking card; as card; not stretchable; plain; snap-on type; green	<a href="http://www.wago.com/248-501/000-023">www.wago.com/248-501/000-023</a>

Supus modificărilor.



**Nr. articol:** 248-501/000-024

Mini-WSB marking card; as card; not stretchable; plain; snap-on type; violet

[www.wago.com/248-501/000-024](http://www.wago.com/248-501/000-024)**Nr. articol:** 793-501

WMB marking card; as card; not stretchable; plain; snap-on type; white

[www.wago.com/793-501](http://www.wago.com/793-501)**Nr. articol:** 793-501/000-002

WMB marking card; as card; not stretchable; plain; snap-on type; yellow

[www.wago.com/793-501/000-002](http://www.wago.com/793-501/000-002)**Nr. articol:** 793-501/000-005

WMB marking card; as card; not stretchable; plain; snap-on type; red

[www.wago.com/793-501/000-005](http://www.wago.com/793-501/000-005)**Nr. articol:** 793-501/000-006

WMB marking card; as card; not stretchable; plain; snap-on type; blue

[www.wago.com/793-501/000-006](http://www.wago.com/793-501/000-006)**Nr. articol:** 793-501/000-007

WMB marking card; as card; not stretchable; plain; snap-on type; gray

[www.wago.com/793-501/000-007](http://www.wago.com/793-501/000-007)**Nr. articol:** 793-501/000-012

WMB marking card; as card; not stretchable; plain; snap-on type; orange

[www.wago.com/793-501/000-012](http://www.wago.com/793-501/000-012)**Nr. articol:** 793-501/000-017

WMB marking card; as card; not stretchable; plain; snap-on type; light green

[www.wago.com/793-501/000-017](http://www.wago.com/793-501/000-017)**Nr. articol:** 793-501/000-023

WMB marking card; as card; not stretchable; plain; snap-on type; green

[www.wago.com/793-501/000-023](http://www.wago.com/793-501/000-023)**Nr. articol:** 793-501/000-024

WMB marking card; as card; not stretchable; plain; snap-on type; violet

[www.wago.com/793-501/000-024](http://www.wago.com/793-501/000-024)**Nr. articol:** 793-5501

WMB marking card; as card; for terminal block width 5 - 17.5 mm; stretchable 5 - 5.2 mm; plain; snap-on type; white

[www.wago.com/793-5501](http://www.wago.com/793-5501)**Nr. articol:** 793-5501/000-002

WMB marking card; as card; for terminal block width 5 - 17.5 mm; stretchable 5 - 5.2 mm; plain; snap-on type; yellow

[www.wago.com/793-5501/000-002](http://www.wago.com/793-5501/000-002)**Nr. articol:** 793-5501/000-005

WMB marking card; as card; for terminal block width 5 - 17.5 mm; stretchable 5 - 5.2 mm; plain; snap-on type; red

[www.wago.com/793-5501/000-005](http://www.wago.com/793-5501/000-005)

Supus modificărilor.

WAGO Kontakttechnik GmbH & Co. KG  
 /Representative Office Romania  
 Sos. Pipera-Tunari nr. 1/1  
 building 1, 2nd floor | 077190 Voluntari, Ilfov  
 Tel.: +40-(0)31 421 85 68 | Email: info-RO@wago.com

Aveți întrebări despre produsele noastre?  
 Vă stăm la dispoziție pentru preluarea apelului la +40 (0) 31 421 85 68.

**Nr. articol:** 793-5501/000-006

WMB marking card; as card; for terminal block width 5 - 17.5 mm; stretchable 5 - 5.2 mm; plain; snap-on type; blue

[www.wago.com/793-5501/000-006](http://www.wago.com/793-5501/000-006)**Nr. articol:** 793-5501/000-007

WMB marking card; as card; for terminal block width 5 - 17.5 mm; stretchable 5 - 5.2 mm; plain; snap-on type; gray

[www.wago.com/793-5501/000-007](http://www.wago.com/793-5501/000-007)**Nr. articol:** 793-5501/000-012

WMB marking card; as card; for terminal block width 5 - 17.5 mm; stretchable 5 - 5.2 mm; plain; snap-on type; orange

[www.wago.com/793-5501/000-012](http://www.wago.com/793-5501/000-012)**Nr. articol:** 793-5501/000-014

WMB marking card; as card; for terminal block width 5 - 17.5 mm; stretchable 5 - 5.2 mm; plain; snap-on type; brown

[www.wago.com/793-5501/000-014](http://www.wago.com/793-5501/000-014)**Nr. articol:** 793-5501/000-017

WMB marking card; as card; for terminal block width 5 - 17.5 mm; stretchable 5 - 5.2 mm; plain; snap-on type; green

[www.wago.com/793-5501/000-017](http://www.wago.com/793-5501/000-017)**Nr. articol:** 793-5501/000-023

WMB marking card; as card; for terminal block width 5 - 17.5 mm; stretchable 5 - 5.2 mm; plain; snap-on type; light green

[www.wago.com/793-5501/000-023](http://www.wago.com/793-5501/000-023)**Nr. articol:** 793-5501/000-024

WMB marking card; as card; for terminal block width 5 - 17.5 mm; stretchable 5 - 5.2 mm; plain; snap-on type; violet

[www.wago.com/793-5501/000-024](http://www.wago.com/793-5501/000-024)**check****Nr. articol:** 2002-611TOPJOB®S L-type test plug module; modular; 1-pole; 2,50 mm<sup>2</sup>; gray[www.wago.com/2002-611](http://www.wago.com/2002-611)**Nr. articol:** 2002-649













TOPJOB®S L-type spacer module; modular; e.g., for bridging commoned terminal blocks; gray

[www.wago.com/2002-649](http://www.wago.com/2002-649)**Nr. articol:** 2009-174

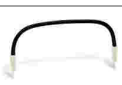
Test plug adapter; for 4 mm Ø test plugs; for testing TOPJOB®S rail-mounted terminal blocks; gray

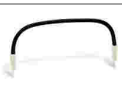

[www.wago.com/2009-174](http://www.wago.com/2009-174)**Nr. articol:** 2009-182Testing tap; for max. 2.5 mm<sup>2</sup>; tool-free connection for individual test wires 0.08 - 2.5 mm; gray[www.wago.com/2009-182](http://www.wago.com/2009-182)**ferrule****Nr. articol:** 216-241Ferrule; Sleeve for 0.5 mm<sup>2</sup> / 20 AWG; insulated; electro-tin plated; electrolytic copper; gastight crimped; acc. to DIN 46228, Part 4/09.90; white[www.wago.com/216-241](http://www.wago.com/216-241)**Nr. articol:** 216-242Ferrule; Sleeve for 0.75 mm<sup>2</sup> / 18 AWG; insulated; electro-tin plated; electrolytic copper; gastight crimped; acc. to DIN 46228, Part 4/09.90; gray[www.wago.com/216-242](http://www.wago.com/216-242)**Nr. articol:** 216-243Ferrule; Sleeve for 1 mm<sup>2</sup> / AWG 18; insulated; electro-tin plated; electrolytic copper; gastight crimped; acc. to DIN 46228, Part 4/09.90; red[www.wago.com/216-243](http://www.wago.com/216-243)**Nr. articol:** 216-244

Supus modificărilor.













	Ferrule; Sleeve for 1.5 mm <sup>2</sup> / AWG 16; insulated; electro-tin plated; electrolytic copper; gastight crimped; acc. to DIN 46228, Part 4/09.90; black	<a href="http://www.wago.com/216-244">www.wago.com/216-244</a>
	<b>Nr. articol: 216-246</b> Ferrule; Sleeve for 2.5 mm <sup>2</sup> / AWG 14; insulated; electro-tin plated; electrolytic copper; gastight crimped; acc. to DIN 46228, Part 4/09.90; blue	<a href="http://www.wago.com/216-246">www.wago.com/216-246</a>
	<b>Nr. articol: 216-262</b> Ferrule; Sleeve for 0.75 mm <sup>2</sup> / 18 AWG; insulated; electro-tin plated; electrolytic copper; gastight crimped; acc. to DIN 46228, Part 4/09.90; gray	<a href="http://www.wago.com/216-262">www.wago.com/216-262</a>
	<b>Nr. articol: 216-263</b> Ferrule; Sleeve for 1 mm <sup>2</sup> / AWG 18; insulated; electro-tin plated; electrolytic copper; gastight crimped; acc. to DIN 46228, Part 4/09.90; red	<a href="http://www.wago.com/216-263">www.wago.com/216-263</a>
	<b>Nr. articol: 216-264</b> Ferrule; Sleeve for 1.5 mm <sup>2</sup> / AWG 16; insulated; electro-tin plated; electrolytic copper; gastight crimped; acc. to DIN 46228, Part 4/09.90; black	<a href="http://www.wago.com/216-264">www.wago.com/216-264</a>
	<b>Nr. articol: 216-266</b> Ferrule; Sleeve for 2.5 mm <sup>2</sup> / AWG 14; insulated; electro-tin plated; electrolytic copper; gastight crimped; acc. to DIN 46228, Part 4/09.90; blue	<a href="http://www.wago.com/216-266">www.wago.com/216-266</a>
<b>Push-In type wire jumper</b>		
	<b>Nr. articol: 2009-412</b> Push-in type wire jumper; insulated; wire length 60 mm; Conductor cross section 1.5 mm <sup>2</sup> ; suitable for 2001, 2002, 2003 and 2022 Series rail-mounted terminal blocks; black	<a href="http://www.wago.com/2009-412">www.wago.com/2009-412</a>
	<b>Nr. articol: 2009-414</b> Push-in type wire jumper; insulated; wire length 110 mm; Conductor cross section 1.5 mm <sup>2</sup> ; suitable for 2001, 2002, 2003 and 2022 Series rail-mounted terminal blocks; black	<a href="http://www.wago.com/2009-414">www.wago.com/2009-414</a>
	<b>Nr. articol: 2009-414/000-005</b> Push-in type wire jumper; insulated; wire length 110 mm; Conductor cross section 1.5 mm <sup>2</sup> ; suitable for 2001, 2002, 2003 and 2022 Series rail-mounted terminal blocks; red	<a href="http://www.wago.com/2009-414/000-005">www.wago.com/2009-414/000-005</a>
	<b>Nr. articol: 2009-414/000-006</b> Push-in type wire jumper; insulated; wire length 110 mm; Conductor cross section 1.5 mm <sup>2</sup> ; suitable for 2001, 2002, 2003 and 2022 Series rail-mounted terminal blocks; blue	<a href="http://www.wago.com/2009-414/000-006">www.wago.com/2009-414/000-006</a>
	<b>Nr. articol: 2009-416</b> Push-in type wire jumper; insulated; wire length 250 mm; Conductor cross section 1.5 mm <sup>2</sup> ; suitable for 2001, 2002, 2003 and 2022 Series rail-mounted terminal blocks; black	<a href="http://www.wago.com/2009-416">www.wago.com/2009-416</a>
<b>tools</b>		
	<b>Nr. articol: 210-658</b> Operating tool; Blade: 3.5 x 0.5 mm; with a partially insulated shaft; angled; short	<a href="http://www.wago.com/210-658">www.wago.com/210-658</a>
	<b>Nr. articol: 210-720</b> Operating tool; Blade: 3.5 x 0.5 mm; with a partially insulated shaft	<a href="http://www.wago.com/210-720">www.wago.com/210-720</a>
<b>End plate</b>		
	<b>Nr. articol: 2002-3291</b> End and intermediate plate; 0.8 mm thick; gray	<a href="http://www.wago.com/2002-3291">www.wago.com/2002-3291</a>
	<b>Nr. articol: 2002-3292</b> End and intermediate plate; 0.8 mm thick; orange	<a href="http://www.wago.com/2002-3292">www.wago.com/2002-3292</a>

Supus modificărilor.















## Insulation stop

	<b>Nr. articol: 2002-171</b> Insulation stop; 0.25 - 0.5 mm <sup>2</sup> ; 5 pieces/strip; light gray	<a href="http://www.wago.com/2002-171">www.wago.com/2002-171</a>
	<b>Nr. articol: 2002-172</b> Insulation stop; 0.75 - 1 mm <sup>2</sup> ; 5 pieces/strip; dark gray	<a href="http://www.wago.com/2002-172">www.wago.com/2002-172</a>

















## Jumper

	<b>Nr. articol: 2002-400</b> Adjacent jumper for continuous commoning; insulated; 2-way; Nominal current 25 A; light gray	<a href="http://www.wago.com/2002-400">www.wago.com/2002-400</a>
	<b>Nr. articol: 2002-402</b> Push-in type jumper bar; insulated; 2-way; Nominal current 25 A; light gray	<a href="http://www.wago.com/2002-402">www.wago.com/2002-402</a>
	<b>Nr. articol: 2002-402/000-005</b> Push-in type jumper bar; insulated; 2-way; Nominal current 25 A; red	<a href="http://www.wago.com/2002-402/000-005">www.wago.com/2002-402/000-005</a>
	<b>Nr. articol: 2002-402/000-006</b> Push-in type jumper bar; insulated; 2-way; Nominal current 25 A; blue	<a href="http://www.wago.com/2002-402/000-006">www.wago.com/2002-402/000-006</a>
	<b>Nr. articol: 2002-403</b> Push-in type jumper bar; insulated; 3-way; Nominal current 25 A; light gray	<a href="http://www.wago.com/2002-403">www.wago.com/2002-403</a>
	<b>Nr. articol: 2002-403/000-005</b> Push-in type jumper bar; insulated; 3-way; Nominal current 25 A; red	<a href="http://www.wago.com/2002-403/000-005">www.wago.com/2002-403/000-005</a>
	<b>Nr. articol: 2002-403/000-006</b> Push-in type jumper bar; insulated; 3-way; Nominal current 25 A; blue	<a href="http://www.wago.com/2002-403/000-006">www.wago.com/2002-403/000-006</a>
	<b>Nr. articol: 2002-404</b> Push-in type jumper bar; insulated; 4-way; Nominal current 25 A; light gray	<a href="http://www.wago.com/2002-404">www.wago.com/2002-404</a>
	<b>Nr. articol: 2002-404/000-005</b> Push-in type jumper bar; insulated; 4-way; Nominal current 25 A; red	<a href="http://www.wago.com/2002-404/000-005">www.wago.com/2002-404/000-005</a>
	<b>Nr. articol: 2002-404/000-006</b> Push-in type jumper bar; insulated; 4-way; Nominal current 25 A; blue	<a href="http://www.wago.com/2002-404/000-006">www.wago.com/2002-404/000-006</a>
	<b>Nr. articol: 2002-405</b> Push-in type jumper bar; insulated; 5-way; Nominal current 25 A; light gray	<a href="http://www.wago.com/2002-405">www.wago.com/2002-405</a>
	<b>Nr. articol: 2002-405/000-005</b> Push-in type jumper bar; insulated; 5-way; Nominal current 25 A; red	<a href="http://www.wago.com/2002-405/000-005">www.wago.com/2002-405/000-005</a>

Supus modificărilor.

	<b>Nr. articol:</b> 2002-405/000-006 Push-in type jumper bar; insulated; 5-way; Nominal current 25 A; blue	<a href="http://www.wago.com/2002-405/000-006">www.wago.com/2002-405/000-006</a>
	<b>Nr. articol:</b> 2002-405/011-000 Star point jumper; insulated; 3-way (1-3-5); IN = IN terminal block; light gray	<a href="http://www.wago.com/2002-405/011-000">www.wago.com/2002-405/011-000</a>
	<b>Nr. articol:</b> 2002-406 Push-in type jumper bar; insulated; 6-way; Nominal current 25 A; light gray	<a href="http://www.wago.com/2002-406">www.wago.com/2002-406</a>
	<b>Nr. articol:</b> 2002-406/000-005 Push-in type jumper bar; insulated; 6-way; Nominal current 25 A; red	<a href="http://www.wago.com/2002-406/000-005">www.wago.com/2002-406/000-005</a>
	<b>Nr. articol:</b> 2002-406/000-006 Push-in type jumper bar; insulated; 6-way; Nominal current 25 A; blue	<a href="http://www.wago.com/2002-406/000-006">www.wago.com/2002-406/000-006</a>
	<b>Nr. articol:</b> 2002-406/020-000 Delta jumper; insulated; 1-2 3-4 5-6; IN = IN terminal block; light gray	<a href="http://www.wago.com/2002-406/020-000">www.wago.com/2002-406/020-000</a>
	<b>Nr. articol:</b> 2002-407 Push-in type jumper bar; insulated; 7-way; Nominal current 25 A; light gray	<a href="http://www.wago.com/2002-407">www.wago.com/2002-407</a>
	<b>Nr. articol:</b> 2002-407/000-005 Push-in type jumper bar; insulated; 7-way; Nominal current 25 A; red	<a href="http://www.wago.com/2002-407/000-005">www.wago.com/2002-407/000-005</a>
	<b>Nr. articol:</b> 2002-407/000-006 Push-in type jumper bar; insulated; 7-way; Nominal current 25 A; blue	<a href="http://www.wago.com/2002-407/000-006">www.wago.com/2002-407/000-006</a>
	<b>Nr. articol:</b> 2002-408 Push-in type jumper bar; insulated; 8-way; Nominal current 25 A; light gray	<a href="http://www.wago.com/2002-408">www.wago.com/2002-408</a>
	<b>Nr. articol:</b> 2002-408/000-005 Push-in type jumper bar; insulated; 8-way; Nominal current 25 A; red	<a href="http://www.wago.com/2002-408/000-005">www.wago.com/2002-408/000-005</a>
	<b>Nr. articol:</b> 2002-408/000-006 Push-in type jumper bar; insulated; 8-way; Nominal current 25 A; blue	<a href="http://www.wago.com/2002-408/000-006">www.wago.com/2002-408/000-006</a>
	<b>Nr. articol:</b> 2002-409 Push-in type jumper bar; insulated; 9-way; Nominal current 25 A; light gray	<a href="http://www.wago.com/2002-409">www.wago.com/2002-409</a>
	<b>Nr. articol:</b> 2002-409/000-005 Push-in type jumper bar; insulated; 9-way; Nominal current 25 A; red	<a href="http://www.wago.com/2002-409/000-005">www.wago.com/2002-409/000-005</a>











Supus modificărilor.

	<b>Nr. articol:</b> 2002-409/000-006 Push-in type jumper bar; insulated; 9-way; Nominal current 25 A; blue	<a href="http://www.wago.com/2002-409/000-006">www.wago.com/2002-409/000-006</a>
	<b>Nr. articol:</b> 2002-410 Push-in type jumper bar; insulated; 10-way; Nominal current 25 A; light gray	<a href="http://www.wago.com/2002-410">www.wago.com/2002-410</a>
	<b>Nr. articol:</b> 2002-410/000-005 Push-in type jumper bar; insulated; 10-way; Nominal current 25 A; red	<a href="http://www.wago.com/2002-410/000-005">www.wago.com/2002-410/000-005</a>
	<b>Nr. articol:</b> 2002-410/000-006 Push-in type jumper bar; insulated; 10-way; Nominal current 25 A; blue	<a href="http://www.wago.com/2002-410/000-006">www.wago.com/2002-410/000-006</a>
	<b>Nr. articol:</b> 2002-423 Adjacent jumper for continuous commoning; insulated; from 1 to 3; Nominal current 25 A; light gray	<a href="http://www.wago.com/2002-423">www.wago.com/2002-423</a>
	<b>Nr. articol:</b> 2002-423/000-005 Adjacent jumper for continuous commoning; insulated; from 1 to 3; Nominal current 25 A; red	<a href="http://www.wago.com/2002-423/000-005">www.wago.com/2002-423/000-005</a>
	<b>Nr. articol:</b> 2002-423/000-006 Adjacent jumper for continuous commoning; insulated; from 1 to 3; Nominal current 25 A; blue	<a href="http://www.wago.com/2002-423/000-006">www.wago.com/2002-423/000-006</a>
	<b>Nr. articol:</b> 2002-433 Push-in type jumper bar; insulated; from 1 to 3; Nominal current 25 A; light gray	<a href="http://www.wago.com/2002-433">www.wago.com/2002-433</a>
	<b>Nr. articol:</b> 2002-434 Push-in type jumper bar; insulated; from 1 to 4; Nominal current 25 A; light gray	<a href="http://www.wago.com/2002-434">www.wago.com/2002-434</a>
	<b>Nr. articol:</b> 2002-435 Push-in type jumper bar; insulated; from 1 to 5; Nominal current 25 A; light gray	<a href="http://www.wago.com/2002-435">www.wago.com/2002-435</a>
	<b>Nr. articol:</b> 2002-436 Push-in type jumper bar; insulated; from 1 to 6; Nominal current 25 A; light gray	<a href="http://www.wago.com/2002-436">www.wago.com/2002-436</a>
	<b>Nr. articol:</b> 2002-437 Push-in type jumper bar; insulated; from 1 to 7; Nominal current 25 A; light gray	<a href="http://www.wago.com/2002-437">www.wago.com/2002-437</a>
	<b>Nr. articol:</b> 2002-438 Push-in type jumper bar; insulated; from 1 to 8; Nominal current 25 A; light gray	<a href="http://www.wago.com/2002-438">www.wago.com/2002-438</a>
	<b>Nr. articol:</b> 2002-439 Push-in type jumper bar; insulated; from 1 to 9; Nominal current 25 A; light gray	<a href="http://www.wago.com/2002-439">www.wago.com/2002-439</a>
	<b>Nr. articol:</b> 2002-440 Push-in type jumper bar; insulated; from 1 to 10; Nominal current 25 A; light gray	<a href="http://www.wago.com/2002-440">www.wago.com/2002-440</a>
	<b>Nr. articol:</b> 2002-472 Staggered jumper; insulated; 2-way; Nominal current 25 A; suitable for 2002 and 2003 Series rail-mounted terminal blocks; light gray	<a href="http://www.wago.com/2002-472">www.wago.com/2002-472</a>

Supus modificărilor.

WAGO Kontakttechnik GmbH & Co. KG  
/Representative Office Romania  
Sos. Pipera-Tunari nr. 1/1  
building 1, 2nd floor | 077190 Voluntari, Ilfov  
Tel.: +40-(0)31 421 85 68 | Email: info-RO@wago.com





Aveți întrebări despre produsele noastre?  
Vă stăm la dispoziție pentru preluarea apelului la +40 (0) 31 421 85 68.

	<b>Nr. articol: 2002-473</b> Staggered jumper; insulated; 3-way; Nominal current 25 A; suitable for 2002 and 2003 Series rail-mounted terminal blocks; light gray	<a href="http://www.wago.com/2002-473">www.wago.com/2002-473</a>
	<b>Nr. articol: 2002-473/011-000</b> Ready-made staggered jumper; insulated; 2-way (1-3); Nominal current 25 A; with contact lugs broken off at the factory and circuit marking; light gray	<a href="http://www.wago.com/2002-473/011-000">www.wago.com/2002-473/011-000</a>
	<b>Nr. articol: 2002-474</b> Staggered jumper; insulated; 4-way; Nominal current 25 A; suitable for 2002 and 2003 Series rail-mounted terminal blocks; light gray	<a href="http://www.wago.com/2002-474">www.wago.com/2002-474</a>
	<b>Nr. articol: 2002-475</b> Staggered jumper; insulated; 5-way; Nominal current 25 A; suitable for 2002 and 2003 Series rail-mounted terminal blocks; light gray	<a href="http://www.wago.com/2002-475">www.wago.com/2002-475</a>
	<b>Nr. articol: 2002-475/011-000</b> Ready-made staggered jumper; insulated; 3-way (1-3-5); Nominal current 25 A; with contact lugs broken off at the factory and circuit marking; light gray	<a href="http://www.wago.com/2002-475/011-000">www.wago.com/2002-475/011-000</a>
	<b>Nr. articol: 2002-476</b> Staggered jumper; insulated; 6-way; Nominal current 25 A; suitable for 2002 and 2003 Series rail-mounted terminal blocks; light gray	<a href="http://www.wago.com/2002-476">www.wago.com/2002-476</a>
	<b>Nr. articol: 2002-477</b> Staggered jumper; insulated; 7-way; Nominal current 25 A; suitable for 2002 and 2003 Series rail-mounted terminal blocks; light gray	<a href="http://www.wago.com/2002-477">www.wago.com/2002-477</a>
	<b>Nr. articol: 2002-477/011-000</b> Ready-made staggered jumper; insulated; 1-3-5-7; Nominal current 25 A; with contact lugs broken off at the factory and circuit marking; light gray	<a href="http://www.wago.com/2002-477/011-000">www.wago.com/2002-477/011-000</a>
	<b>Nr. articol: 2002-478</b> Staggered jumper; insulated; 8-way; Nominal current 25 A; suitable for 2002 and 2003 Series rail-mounted terminal blocks; light gray	<a href="http://www.wago.com/2002-478">www.wago.com/2002-478</a>
	<b>Nr. articol: 2002-479</b> Staggered jumper; insulated; 9-way; Nominal current 25 A; suitable for 2002 and 2003 Series rail-mounted terminal blocks; light gray	<a href="http://www.wago.com/2002-479">www.wago.com/2002-479</a>
	<b>Nr. articol: 2002-479/011-000</b> Ready-made staggered jumper; insulated; 1-3-5-7-9; Nominal current 25 A; with contact lugs broken off at the factory and circuit marking; light gray	<a href="http://www.wago.com/2002-479/011-000">www.wago.com/2002-479/011-000</a>
	<b>Nr. articol: 2002-480</b> Staggered jumper; insulated; 10-way; Nominal current 25 A; suitable for 2002 and 2003 Series rail-mounted terminal blocks; light gray	<a href="http://www.wago.com/2002-480">www.wago.com/2002-480</a>
	<b>Nr. articol: 2002-481</b> Staggered jumper; insulated; 11-way; Nominal current 25 A; suitable for 2002 and 2003 Series rail-mounted terminal blocks; light gray	<a href="http://www.wago.com/2002-481">www.wago.com/2002-481</a>
	<b>Nr. articol: 2002-481/011-000</b> Ready-made staggered jumper; insulated; 1-3-5-7-9-11; Nominal current 25 A; with contact lugs broken off at the factory and circuit marking; light gray	<a href="http://www.wago.com/2002-481/011-000">www.wago.com/2002-481/011-000</a>
	<b>Nr. articol: 2002-482</b> Staggered jumper; insulated; 12-way; Nominal current 25 A; suitable for 2002 and 2003 Series rail-mounted terminal blocks; light gray	<a href="http://www.wago.com/2002-482">www.wago.com/2002-482</a>

Supus modificărilor.

WAGO Kontakttechnik GmbH & Co. KG  
/Representative Office Romania  
Sos. Pipera-Tunari nr. 1/1  
building 1, 2nd floor | 077190 Voluntari, Ilfov  
Tel.: +40-(0)31 421 85 68 | Email: info-RO@wago.com

Aveți întrebări despre produsele noastre?  
Vă stăm la dispoziție pentru preluarea apelului la +40 (0) 31 421 85 68.

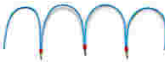
	<b>Nr. articol: 2002-492</b> Double-deck vertical jumper; insulated; light gray	<a href="http://www.wago.com/2002-492">www.wago.com/2002-492</a>
	<b>Nr. articol: 2002-492/000-012</b> Double-deck vertical jumper; insulated; orange	<a href="http://www.wago.com/2002-492/000-012">www.wago.com/2002-492/000-012</a>
	<b>Nr. articol: 2002-493</b> Triple-deck vertical jumper; insulated; light gray	<a href="http://www.wago.com/2002-493">www.wago.com/2002-493</a>
	<b>Nr. articol: 210-103</b> Wire commoning chain; insulated; 50 connections; black	<a href="http://www.wago.com/210-103">www.wago.com/210-103</a>
	<b>Nr. articol: 210-123</b> Wire commoning chain; insulated; 50 connections	<a href="http://www.wago.com/210-123">www.wago.com/210-123</a>

## Descărcări

### Documentation

#### Additional Information

Technical explanations	Apr 3, 2019	pdf 2,1 MB	Descărcare
------------------------	-------------	---------------	------------

### CAD/CAE-Data

#### CAD data

2D/3D Models 2002-3231	URL	Descărcare
------------------------	-----	------------

#### CAE data

EPLAN Data Portal 2002-3231	URL	Descărcare
-----------------------------	-----	------------

WSCAD Universe 2002-3231	URL	Descărcare
--------------------------	-----	------------

### Installation Notes

#### Conductor termination

Supus modificărilor.

WAGO Kontakttechnik GmbH & Co. KG  
/Representative Office Romania  
Sos. Pipera-Tunari nr. 1/1  
building 1, 2nd floor | 077190 Voluntari, Ilfov  
Tel.: +40-(0)31 421 85 68 | Email: info-RO@wago.com

Aveți întrebări despre produsele noastre?  
Vă stăm la dispoziție pentru preluarea apelului la +40 (0) 31 421 85 68.



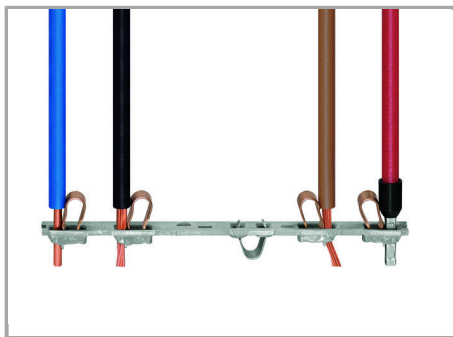

All conductor types at a glance

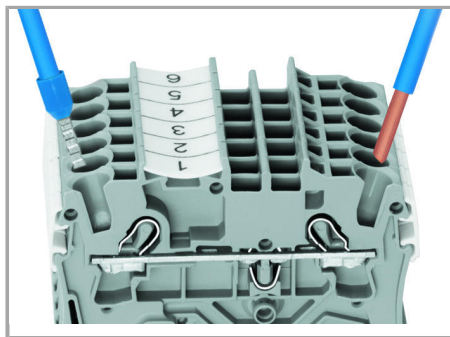

Terminating solid and ferruled conductors via push-in connection.

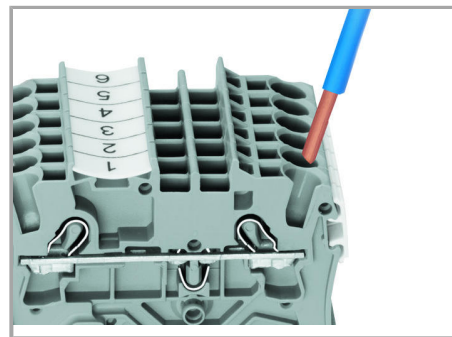

Inserting conductors via push-in termination.

**Solid conductors** with cross-sections from either one size above, or up to two sizes below, the rated cross-section can be simply pushed in – no tools needed.

Supus modificărilor.

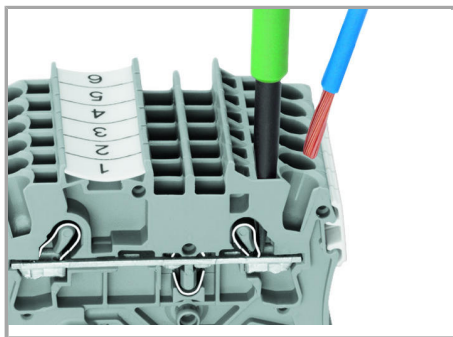

Inserting a conductor via operating tool.

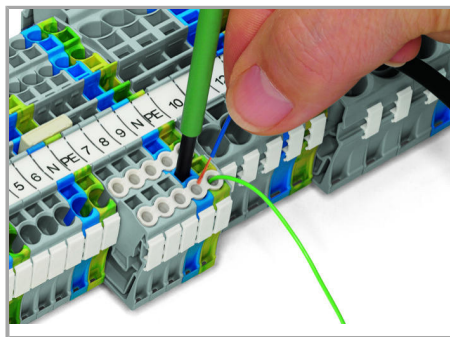

Conductor termination – Insulation stop.

Connecting fine-stranded conductors without ferrules, or small cross-sectional conductors that cannot be pushed in, is performed similarly to the original CAGE CLAMP® – just use an operating tool.

#### The smart feature:

To open the clamp, the operating tool is inserted vertically. The conductor entry is less than 15 degrees for easier wiring.

#### Jumpered

Supus modificărilor.

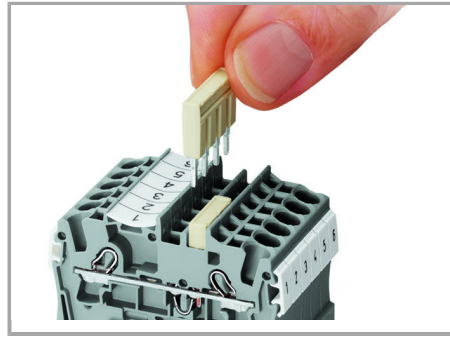
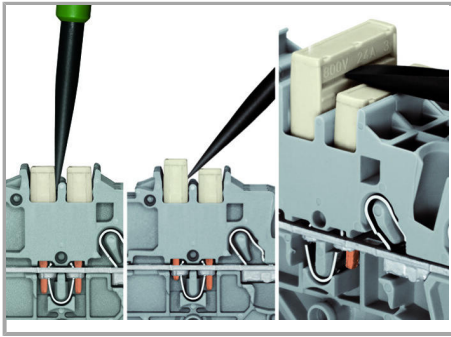

#### Removing a push-in type jumper bar.

Insert the operating tool between the jumper and the partition wall of the dual jumper slots, then lift up the jumper.

Place the operating tool in the center of jumpers up to five contacts (see above), or alternately on both sides for jumpers with more than five contacts.

The push-in type jumper bar system is based on the common plug and socket principle. Each terminal block is spring-loaded with a double socket and a resilient CrNi steel spring. The jumper contact material is pure electrolytic copper, which allows for an extremely small design capable of carrying the full-rated current of the terminal block. Ground terminal blocks can also be commoned using the same jumper system. Custom jumpers are created by breaking and removing jumper contacts (2000, 2001, 2002, 2004 Series).

#### Jumpered

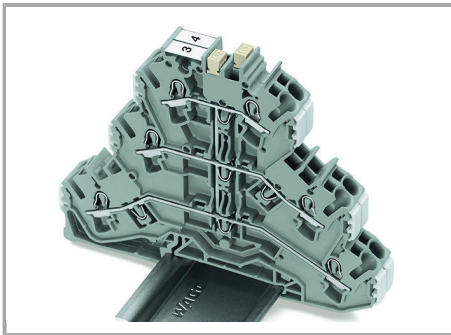

Commoning three levels via triple-deck vertical jumper (2002-493).

Created for double- and triple-deck TOPJOB® S Terminal Blocks, the vertical jumpers can common two or three levels. Clearly marked numerals ("2" and "3") distinguish the double-deck (2002-492) and triple-deck vertical jumpers (2002-493), even when inserted.

#### Familie de produse

Supus modificărilor.

WAGO Kontakttechnik GmbH & Co. KG  
/Representative Office Romania  
Sos. Pipera-Tunari nr. 1/1  
building 1, 2nd floor | 077190 Voluntari, Ilfov  
Tel.: +40-(0)31 421 85 68 | Email: [info-RO@wago.com](mailto:info-RO@wago.com)

Aveți întrebări despre produsele noastre?  
Vă stăm la dispoziție pentru preluarea apelului la +40 (0) 31 421 85 68.



## TOPJOB® S

TOPJOB® S: In various industrial applications and modern building installations, WAGO's wide and versatile range of rail-mount terminal blocks provides more than just reliable electrical connections.

Afișare globală produse din familie.

Supus modificărilor.

---

WAGO Kontakttechnik GmbH & Co. KG  
/Representative Office Romania  
Sos. Pipera-Tunari nr. 1/1  
building 1, 2nd floor | 077190 Voluntari, Ilfov  
Tel.: +40-(0)31 421 85 68 | Email: info-RO@wago.com

Aveți întrebări despre produsele noastre?  
Vă stăm la dispoziție pentru preluarea apelului la +40 (0) 31 421 85 68.