

Fișă tehnică | Număr articol: 770-7105

Linect® T-connector; 5-pole; Cod. I; 1 input; 2 outputs; blue

www.wago.com/770-7105

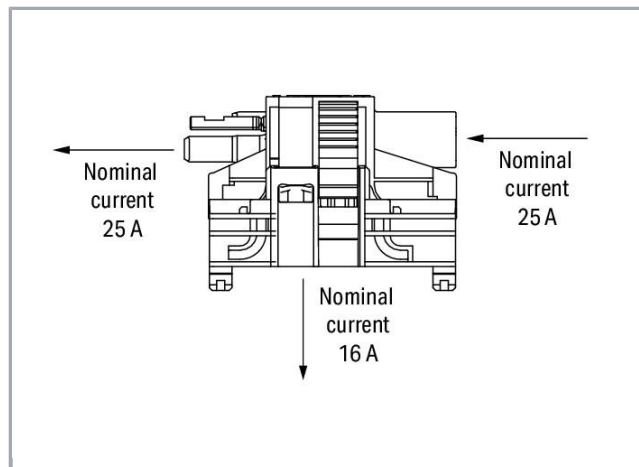
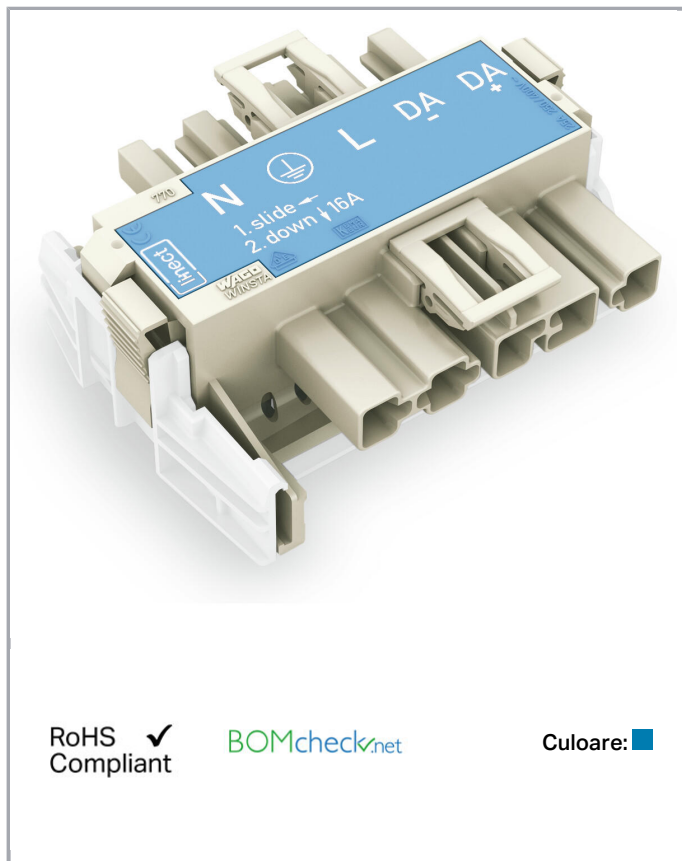

Supus modificărilor.

WAGO Kontakttechnik GmbH & Co. KG
/Representative Office Romania
Sos. Pipera-Tunari nr. 1/1
building 1, 2nd floor | 077190 Voluntari, Ilfov
Tel.: +40-(0)31 421 85 68 | Email: info-RO@wago.com

Aveți întrebări despre produsele noastre?
Vă stăm la dispoziție pentru preluarea apelului la +40 (0) 31 421 85 68.

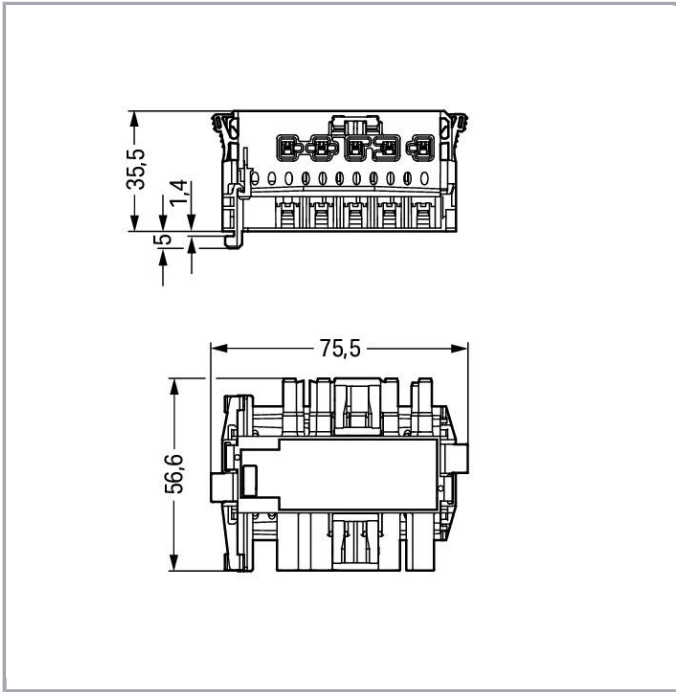

Descriere articol

- Protected against mismatching and maintenance-free
- Additional variable coding is possible

Note:

All connectors for mounted installations (snap-in versions for lighting fixtures or devices, all types of PCB and distribution connectors) are factory-equipped with locking levers to ensure plugs and sockets are securely locked. Additional locking levers are only required for flying leads (plug /socket).

Note on mismatching protection:

All WINSTA[®] components are 100% protected against mismatching when:

- plugging different numbers of poles
- plugging while rotated 180
- plugging while laterally staggered
- plugging one pole

Safety information 1:

Application note for the U.S. market (USR): Some versions may also be used for current interruption in accordance with the UL certificate in select applications with currents below 16 A and voltages up to 600 V. For further information, please contact your local sales office.

Date

Electrical data

Note on Contact Resistance

approx. 1 mΩ of contact resistance approx. 0.25 mΩ contact transition plug/socket

Supus modificărilor.

WAGO Kontakttechnik GmbH & Co. KG
/Representative Office Romania
Sos. Pipera-Tunari nr. 1/1
building 1, 2nd floor | 077190 Voluntari, Ilfov
Tel.: +40-(0)31 421 85 68 | Email: info-RO@wago.com

Aveți întrebări despre produsele noastre?
Vă stăm la dispoziție pentru preluarea apelului la +40 (0) 31 421 85 68.



Ratings per IEC/EN 60664-1

Ratings per	IEC/EN 60664-1
Nominal voltage (III/3)	400 V
Rated surge voltage (III/3)	6 kV
Rated current	25 A
Rated current 2	16 A
Legend (ratings)	(III / 3) \triangleq Overvoltage category III / Pollution degree 3

Approvals per UL 1977

Rated voltage UL 1977	600 V
Rated current UL 1977	23 A

Connection data

Pole No.	5
Total number of potentials	5
Ground function	with preceding ground contact

Geometrical Data

Pin spacing	10 mm / 0.394 inch
Width	75,5 mm / 2.972 inch
Height	40,5 mm / 1.594 inch
Depth	56,6 mm / 2.228 inch

Mechanical data

Technologie	DALI Linect
Coding	I
Mating force of a plug-in connection	approx. 20 ... 70 N (depending on pole number)
Retention force of a plug-in connection	When locked: > 80 N
Unmating force of a plug-in connection	when unlocked: approx. 20 ... 70 N (depending on pole number)
Number of mating cycles	200, without resistive load 100, with resistive load $I_N = 25$ A, tested (4 mm ² /AWG 12)
Distributor type	Linect [®] T-connector
Marking	N L DA- DA+
Protection type	IP20
Note on protection type	Only when mated (these compact connectors are not designed for

Supus modificărilor.

WAGO Kontakttechnik GmbH & Co. KG
/Representative Office Romania
Sos. Pipera-Tunari nr. 1/1
building 1, 2nd floor | 077190 Voluntari, Ilfov
Tel.: +40-(0)31 421 85 68 | Email: info-RO@wago.com

Aveți întrebări despre produsele noastre?
Vă stăm la dispoziție pentru preluarea apelului la +40 (0) 31 421 85 68.

use in open, easily accessible areas).

Potential marking	N L DA- DA+
Application	Lighting management

Plug connection

Contact type (pluggable connector)	Socket/plug
Mismating protection	Yes
Locking of plug-in connection	locking lever
Locking lever	yes

Material Data

Color	blue
Insulation material	Polyamide 66 (PA 66)
Contact material	Copper or copper alloy (surface-treated)
Fire load	0,905 MJ
Weight	41,1 g

Environmental Requirements

Processing temperature	-5 ... +40 °C
Continuous operating temperature	-35 ... +85 °C
Note on continuous operating temperature	Insulating parts for temperatures \leq 105 °C

Commercial data

Product Group	20 (WINSTA)
Packaging type	BOX
Country of origin	DE
GTIN	4050821000402
Customs tariff number	85366990990

Aprobări / certificate

Country specific Approvals









Emblemă	Aprobare	Text de aprobare suplimentar	Nume certificat
	VDE VDE Prüf- und Zertifizierungsinstitut	EN 61535	40029808

Supus modificărilor.

WAGO Kontakttechnik GmbH & Co. KG
 /Representative Office Romania
 Sos. Pipera-Tunari nr. 1/1
 building 1, 2nd floor | 077190 Voluntari, Ilfov
 Tel.: +40-(0)31 421 85 68 | Email: info-RO@wago.com

Aveți întrebări despre produsele noastre?
 Vă stăm la dispoziție pentru preluarea apelului la +40 (0) 31 421 85 68.

Counterpart

	Nr. articol 294-8035 Lighting connector; push-button, external; for Linect®; without ground contact; DA+ DA- L PE N; 5-pole; Cod. I; Lighting side: for solid conductors; Inst. side: for all conductor types; max. 2.5 mm ² ; Surrounding air temperature: max 85°C (T85); 2,50 mm ² ; white	www.wago.com /294-8035
	Nr. articol 294-8135 Lighting connector; push-button, external; for Linect®; with direct ground contact; DA+ DA- L PE N; 5-pole; Cod. I; Lighting side: for solid conductors; Inst. side: for all conductor types; max. 2.5 mm ² ; Surrounding air temperature: max 85°C (T85); 2,50 mm ² ; white	www.wago.com /294-8135
	Nr. articol 770-1105 Socket; 5-pole; Cod. I; 4,00 mm ² ; blue	www.wago.com /770-1105
	Nr. articol 770-1105/022-000 Socket; with strain relief housing; 5-pole; Cod. I; 4,00 mm ² ; blue	www.wago.com /770-1105 /022-000
	Nr. articol 770-1115 Plug; 5-pole; Cod. I; 4,00 mm ² ; blue	www.wago.com /770-1115
	Nr. articol 770-1115/022-000 Plug; with strain relief housing; 5-pole; Cod. I; 4,00 mm ² ; blue	www.wago.com /770-1115 /022-000
	Nr. articol 771-9985/006-102 pre-assembled interconnecting cable; Eca; Socket/plug; 5-pole; Cod. I; H05VV-F 5G 1.5 mm ² ; 1 m; 1,50 mm ² ; blue	www.wago.com /771-9985 /006-102
	Nr. articol 771-9985/106-102 pre-assembled connecting cable; Eca; Socket/open-ended; 5-pole; Cod. I; H05VV-F 5G 1.5 mm ² ; 1 m; 1,50 mm ² ; blue	www.wago.com /771-9985 /106-102
	Nr. articol 771-9985/206-102 pre-assembled connecting cable; Eca; Plug/open-ended; 5-pole; Cod. I; H05VV-F 5G 1.5 mm ² ; 1 m; 1,50 mm ² ; blue	www.wago.com /771-9985 /206-102

Descărcări

CAD/CAE-Data

CAE data

WSCAD Universe 770-7105

URL

Descărcare

Installation Notes

Installation

Supus modificărilor.

WAGO Kontakttechnik GmbH & Co. KG
/Representative Office Romania
Sos. Pipera-Tunari nr. 1/1
building 1, 2nd floor | 077190 Voluntari, Ilfov
Tel.: +40-(0)31 421 85 68 | Email: info-RO@wago.com

Aveți întrebări despre produsele noastre?
Vă stăm la dispoziție pentru preluarea apelului la +40 (0) 31 421 85 68.

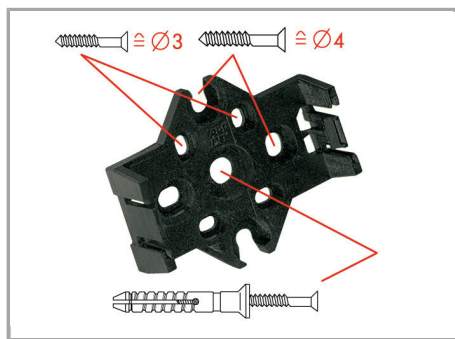

The mounting plate for distribution connectors can be mounted using commercially available screws or nail-drive anchors.



The distribution connectors are latched when mounted on the mounting plate.



To release the distribution connector, unlock the latch using a screwdriver.

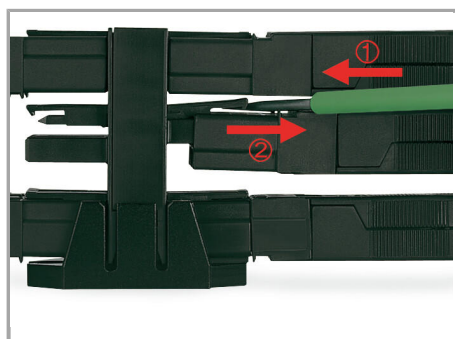

All distributor connections are locked and protected against accidental disconnection directly after mating. Locking of any connection is released using a screwdriver, even if all connections are in use.

Familie de produse

WINSTA® MIDI

Afișare globală produse din familie.

Supus modificărilor.