

## Fișă tehnică | Număr articol: 284-621

Distribution terminal block; 10 mm<sup>2</sup>; lateral marker slots; for DIN-rail 35 x 15 and 35 x 7.5; screw-type and CAGE CLAMP® connection; 3 x CAGE CLAMP® connection 10 mm<sup>2</sup>; 1 x screw-clamp connection 35 mm<sup>2</sup>; 10,00 mm<sup>2</sup>; gray

[www.wago.com/284-621](http://www.wago.com/284-621)

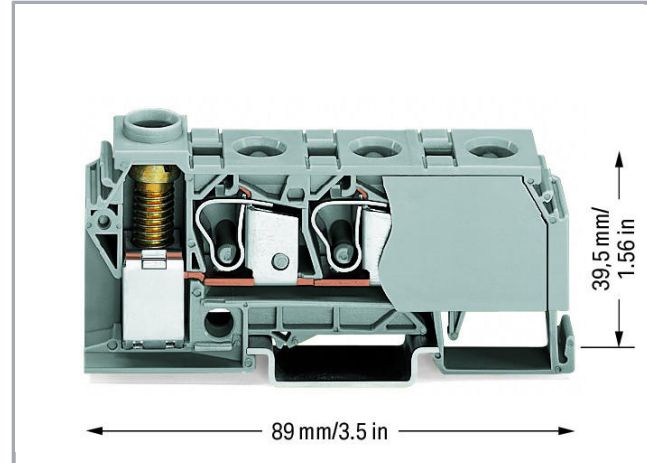
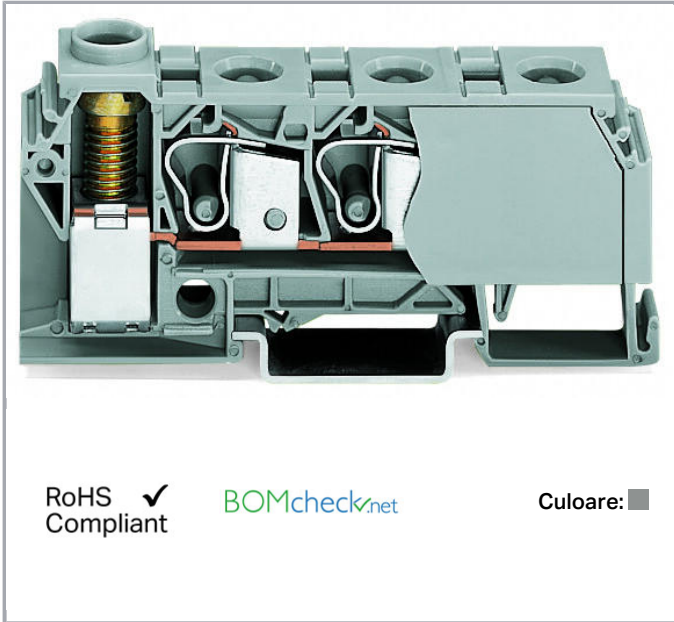

### Descriere articol

**Safety information 1:**  
Screw torque: 3.5 Nm

### Date

#### Electrical data

#### Ratings per IEC/EN 60664-1

Nominal voltage (III/3)	800 V
Rated surge voltage (III/3)	8 kV
Rated current	125 A
Legend (ratings)	(III / 3) ≙ Overvoltage category III / Pollution degree 3

#### Connection data

Connection technology	CAGE CLAMP®
Number of connection points (connection type)	3

Supus modificărilor.

WAGO Kontakttechnik GmbH & Co. KG  
/Representative Office Romania  
Sos. Pipera-Tunari nr. 1/1  
building 1, 2nd floor | 077190 Voluntari, Ilfov  
Tel.: +40-(0)31 421 85 68 | Email: info-RO@wago.com

Aveți întrebări despre produsele noastre?  
Vă stăm la dispoziție pentru preluarea apelului la +40 (0) 31 421 85 68.



Actuation type	Operating tool
Connectable conductor materials	Copper
Solid conductor	0,2 ... 10 mm <sup>2</sup> / 24 ... 8 AWG
Fine-stranded conductor	0,2 ... 10 mm <sup>2</sup> / 24 ... 8 AWG
Strip length	12 ... 14 mm / 0.47 ... 0.55 inch
Connection technology 2	Screw-type connection
Number of connection points	1
Solid conductor 2	6 ... 35 mm <sup>2</sup> / 10 ... 2 AWG
Fine-stranded conductor 2	6 ... 35 mm <sup>2</sup> / 10 ... 2 AWG
Total number of connection points	4
Total number of potentials	1
Number of levels	1
Wiring type	Front-/side-entry wiring

### Geometrical Data

Width	17,5 mm / 0.689 inch
Height from upper-edge of DIN-rail	39,5 mm / 1.555 inch
Depth	89 mm / 3.504 inch

### Mechanical data

Design	horizontal type
Mounting type	DIN-35 rail
Marking level	Side marking
Torque	3,5 Nm

### Material Data

Color	gray
Insulation material	Polyamide 66 (PA 66)
Weight	55,5 g

### Commercial data

Packaging type	BOX
Country of origin	IN
GTIN	4045454282561
Customs tariff number	85369010000



Supus modificărilor.

WAGO Kontakttechnik GmbH & Co. KG  
 /Representative Office Romania  
 Sos. Pipera-Tunari nr. 1/1  
 building 1, 2nd floor | 077190 Voluntari, Ilfov  
 Tel.: +40-(0)31 421 85 68 | Email: info-RO@wago.com



Aveți întrebări despre produsele noastre?  
 Vă stăm la dispoziție pentru preluarea apelului la +40 (0) 31 421 85 68.

## Aprobări / certificate

## Country specific Approvals

Emblemă	Aprobare	Text de aprobare suplimentar	Nume certificat
	CCA DEKRA Certification B.V.	EN 60947	2160584.03
	CCA DEKRA Certification B.V.	EN 60947	NTR NL-7078
	CSA DEKRA Certification B.V.	C22.2 No. 158	1536073

## Ship Approvals

Emblemă	Aprobare	Text de aprobare suplimentar	Nume certificat
	BV Bureau Veritas S.A.	EN 60947	07436/E0 BV
	DNV GL Det Norske Veritas, Germanischer Lloyd	-	TAE00001V2

## UL-Approvals

Emblemă	Aprobare	Text de aprobare suplimentar	Nume certificat
	UL Underwriters Laboratories Inc.	UL 1059	20170731-E45172

## Counterpart











Supus modificărilor.

WAGO Kontakttechnik GmbH & Co. KG  
/Representative Office Romania  
Sos. Pipera-Tunari nr. 1/1  
building 1, 2nd floor | 077190 Voluntari, Ilfov  
Tel.: +40-(0)31 421 85 68 | Email: info-RO@wago.com













Aveți întrebări despre produsele noastre?  
Vă stăm la dispoziție pentru preluarea apelului la +40 (0) 31 421 85 68.

## Produse compatibile

### Marking accessories

	<b>Nr. articol: 2009-115</b> WMB-Inline; for Smart Printer; 1500 pieces on roll; stretchable 5 - 5.2 mm; plain; snap-on type; white	<a href="http://www.wago.com/2009-115">www.wago.com/2009-115</a>
	<b>Nr. articol: 2009-115/000-002</b> WMB-Inline; for Smart Printer; 1500 pieces on roll; stretchable 5 - 5.2 mm; plain; snap-on type; yellow	<a href="http://www.wago.com/2009-115/000-002">www.wago.com/2009-115/000-002</a>
	<b>Nr. articol: 2009-115/000-006</b> WMB-Inline; for Smart Printer; 1500 pieces on roll; stretchable 5 - 5.2 mm; plain; snap-on type; blue	<a href="http://www.wago.com/2009-115/000-006">www.wago.com/2009-115/000-006</a>
	<b>Nr. articol: 2009-115/000-007</b> WMB-Inline; for Smart Printer; 1500 pieces on roll; stretchable 5 - 5.2 mm; plain; snap-on type; gray	<a href="http://www.wago.com/2009-115/000-007">www.wago.com/2009-115/000-007</a>
	<b>Nr. articol: 2009-115/000-012</b> WMB-Inline; for Smart Printer; 1500 pieces on roll; stretchable 5 - 5.2 mm; plain; snap-on type; orange	<a href="http://www.wago.com/2009-115/000-012">www.wago.com/2009-115/000-012</a>
	<b>Nr. articol: 2009-115/000-017</b> WMB-Inline; for Smart Printer; 1500 pieces on roll; stretchable 5 - 5.2 mm; plain; snap-on type; light green	<a href="http://www.wago.com/2009-115/000-017">www.wago.com/2009-115/000-017</a>
	<b>Nr. articol: 2009-115/000-023</b> WMB-Inline; for Smart Printer; 1500 pieces on roll; stretchable 5 - 5.2 mm; plain; snap-on type; green	<a href="http://www.wago.com/2009-115/000-023">www.wago.com/2009-115/000-023</a>
	<b>Nr. articol: 2009-115/000-024</b> WMB-Inline; for Smart Printer; 1500 pieces on roll; stretchable 5 - 5.2 mm; plain; snap-on type; violet	<a href="http://www.wago.com/2009-115/000-024">www.wago.com/2009-115/000-024</a>
	<b>Nr. articol: 793-501</b> WMB marking card; as card; not stretchable; plain; snap-on type; white	<a href="http://www.wago.com/793-501">www.wago.com/793-501</a>
	<b>Nr. articol: 793-501/000-002</b> WMB marking card; as card; not stretchable; plain; snap-on type; yellow	<a href="http://www.wago.com/793-501/000-002">www.wago.com/793-501/000-002</a>
	<b>Nr. articol: 793-501/000-005</b> WMB marking card; as card; not stretchable; plain; snap-on type; red	<a href="http://www.wago.com/793-501/000-005">www.wago.com/793-501/000-005</a>

Supus modificărilor.

	<b>Nr. articol: 793-501/000-006</b> WMB marking card; as card; not stretchable; plain; snap-on type; blue	<a href="http://www.wago.com/793-501/000-006">www.wago.com/793-501/000-006</a>
	<b>Nr. articol: 793-501/000-007</b> WMB marking card; as card; not stretchable; plain; snap-on type; gray	<a href="http://www.wago.com/793-501/000-007">www.wago.com/793-501/000-007</a>
	<b>Nr. articol: 793-501/000-012</b> WMB marking card; as card; not stretchable; plain; snap-on type; orange	<a href="http://www.wago.com/793-501/000-012">www.wago.com/793-501/000-012</a>
	<b>Nr. articol: 793-501/000-017</b> WMB marking card; as card; not stretchable; plain; snap-on type; light green	<a href="http://www.wago.com/793-501/000-017">www.wago.com/793-501/000-017</a>
	<b>Nr. articol: 793-501/000-023</b> WMB marking card; as card; not stretchable; plain; snap-on type; green	<a href="http://www.wago.com/793-501/000-023">www.wago.com/793-501/000-023</a>
	<b>Nr. articol: 793-501/000-024</b> WMB marking card; as card; not stretchable; plain; snap-on type; violet	<a href="http://www.wago.com/793-501/000-024">www.wago.com/793-501/000-024</a>
	<b>Nr. articol: 793-5501</b> WMB marking card; as card; for terminal block width 5 - 17.5 mm; stretchable 5 - 5.2 mm; plain; snap-on type; white	<a href="http://www.wago.com/793-5501">www.wago.com/793-5501</a>
	<b>Nr. articol: 793-5501/000-002</b> WMB marking card; as card; for terminal block width 5 - 17.5 mm; stretchable 5 - 5.2 mm; plain; snap-on type; yellow	<a href="http://www.wago.com/793-5501/000-002">www.wago.com/793-5501/000-002</a>
	<b>Nr. articol: 793-5501/000-005</b> WMB marking card; as card; for terminal block width 5 - 17.5 mm; stretchable 5 - 5.2 mm; plain; snap-on type; red	<a href="http://www.wago.com/793-5501/000-005">www.wago.com/793-5501/000-005</a>
	<b>Nr. articol: 793-5501/000-006</b> WMB marking card; as card; for terminal block width 5 - 17.5 mm; stretchable 5 - 5.2 mm; plain; snap-on type; blue	<a href="http://www.wago.com/793-5501/000-006">www.wago.com/793-5501/000-006</a>
	<b>Nr. articol: 793-5501/000-007</b> WMB marking card; as card; for terminal block width 5 - 17.5 mm; stretchable 5 - 5.2 mm; plain; snap-on type; gray	<a href="http://www.wago.com/793-5501/000-007">www.wago.com/793-5501/000-007</a>
	<b>Nr. articol: 793-5501/000-012</b> WMB marking card; as card; for terminal block width 5 - 17.5 mm; stretchable 5 - 5.2 mm; plain; snap-on type; orange	<a href="http://www.wago.com/793-5501/000-012">www.wago.com/793-5501/000-012</a>
	<b>Nr. articol: 793-5501/000-017</b> WMB marking card; as card; for terminal block width 5 - 17.5 mm; stretchable 5 - 5.2 mm; plain; snap-on type; green	<a href="http://www.wago.com/793-5501/000-017">www.wago.com/793-5501/000-017</a>

Supus modificărilor.

WAGO Kontakttechnik GmbH & Co. KG  
/Representative Office Romania  
Sos. Pipera-Tunari nr. 1/1  
building 1, 2nd floor | 077190 Voluntari, Ilfov  
Tel.: +40-(0)31 421 85 68 | Email: info-RO@wago.com

Aveți întrebări despre produsele noastre?  
Vă stăm la dispoziție pentru preluarea apelului la +40 (0) 31 421 85 68.

**Nr. articol:** 793-5501/000-023WMB marking card; as card; for terminal block width 5 - 17.5 mm; stretchable 5 - 5.2 mm; plain; snap-on type; light green [www.wago.com/793-5501/000-023](http://www.wago.com/793-5501/000-023)**Nr. articol:** 793-5501/000-024WMB marking card; as card; for terminal block width 5 - 17.5 mm; stretchable 5 - 5.2 mm; plain; snap-on type; violet [www.wago.com/793-5501/000-024](http://www.wago.com/793-5501/000-024)**General accessories****Nr. articol:** 284-400Finger guard; touchproof cover protects unused conductor entries; yellow [www.wago.com/284-400](http://www.wago.com/284-400)**Nr. articol:** 709-311B-type spacer module; modular; e.g., for bridging commoned terminal blocks; gray [www.wago.com/709-311](http://www.wago.com/709-311)**Jumper****Nr. articol:** 284-412Comb-style jumper bar; insulated; Nominal current 125 A; 2-way; gray [www.wago.com/284-412](http://www.wago.com/284-412)**ferrule****Nr. articol:** 216-108Ferrule; Sleeve for 6 mm<sup>2</sup> / AWG 10; uninsulated; electro-tin plated [www.wago.com/216-108](http://www.wago.com/216-108)**Nr. articol:** 216-208Ferrule; Sleeve for 6 mm<sup>2</sup> / AWG 10; insulated; electro-tin plated; electrolytic copper; gastight crimped; acc. to DIN 46228, Part 4/09.90; yellow [www.wago.com/216-208](http://www.wago.com/216-208)**Nr. articol:** 216-262Ferrule; Sleeve for 0.75 mm<sup>2</sup> / 18 AWG; insulated; electro-tin plated; electrolytic copper; gastight crimped; acc. to DIN 46228, Part 4/09.90; gray [www.wago.com/216-262](http://www.wago.com/216-262)**Nr. articol:** 216-263Ferrule; Sleeve for 1 mm<sup>2</sup> / AWG 18; insulated; electro-tin plated; electrolytic copper; gastight crimped; acc. to DIN 46228, Part 4/09.90; red [www.wago.com/216-263](http://www.wago.com/216-263)**Nr. articol:** 216-264Ferrule; Sleeve for 1.5 mm<sup>2</sup> / AWG 16; insulated; electro-tin plated; electrolytic copper; gastight crimped; acc. to DIN 46228, Part 4/09.90; black [www.wago.com/216-264](http://www.wago.com/216-264)**Nr. articol:** 216-266Ferrule; Sleeve for 2.5 mm<sup>2</sup> / AWG 14; insulated; electro-tin plated; electrolytic copper; gastight crimped; acc. to DIN 46228, Part 4/09.90; blue [www.wago.com/216-266](http://www.wago.com/216-266)**Nr. articol:** 216-267Ferrule; Sleeve for 4 mm<sup>2</sup> / AWG 12; insulated; electro-tin plated; electrolytic copper; gastight crimped; acc. to DIN 46228, Part 4/09.90; gray [www.wago.com/216-267](http://www.wago.com/216-267)**tools****Nr. articol:** 210-721Operating tool; Blade: 5.5 x 0.8 mm; with a partially insulated shaft [www.wago.com/210-721](http://www.wago.com/210-721)**assembling****Nr. articol:** 209-106Mounting carrier; for isolated mounting on DIN 35 rails; gray [www.wago.com/209-106](http://www.wago.com/209-106)

Supus modificărilor.



Nr. articol: 709-154

Cover; Type 2; suitable for cover carrier, type 2; 1 m long; transparent

[www.wago.com/709-154](http://www.wago.com/709-154)

## Carrier rail



Nr. articol: 210-112

Steel carrier rail; 35 x 7.5 mm; 1 mm thick; 2 m long; slotted; according to EN 60715; "Hole width 25 mm

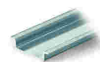
[www.wago.com/210-112](http://www.wago.com/210-112)

Nr. articol: 210-113

Steel carrier rail; 35 x 7.5 mm; 1 mm thick; 2 m long; unslotted; according to EN 60715

[www.wago.com/210-113](http://www.wago.com/210-113)

Nr. articol: 210-114

Steel carrier rail; 35 x 15 mm; 1.5 mm thick; 2 m long; unslotted; similar to EN 60715

[www.wago.com/210-114](http://www.wago.com/210-114)

Nr. articol: 210-115

Steel carrier rail; 35 x 7.5 mm; 1 mm thick; 2 m long; slotted; according to EN 60715; "Hole width 18 mm

[www.wago.com/210-115](http://www.wago.com/210-115)

Nr. articol: 210-118

Steel carrier rail; 35 x 15 mm; 2.3 mm thick; 2 m long; unslotted; according to EN 60715

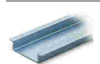
[www.wago.com/210-118](http://www.wago.com/210-118)

Nr. articol: 210-196

Aluminum carrier rail; 35 x 8.2 mm; 1.6 mm thick; 2 m long; unslotted; similar to EN 60715; silver-colored

[www.wago.com/210-196](http://www.wago.com/210-196)

Nr. articol: 210-197

Steel carrier rail; 35 x 15 mm; 1.5 mm thick; 2 m long; slotted; similar to EN 60715

[www.wago.com/210-197](http://www.wago.com/210-197)

Nr. articol: 210-198

Copper carrier rail; 35 x 15 mm; 2.3 mm thick; 2 m long; unslotted; according to EN 60715; copper-colored

[www.wago.com/210-198](http://www.wago.com/210-198)

Nr. articol: 210-504

Steel carrier rail; 35 x 7.5 mm; 1 mm thick; 2 m long; slotted; galvanized; according to EN 60715

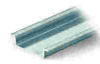
[www.wago.com/210-504](http://www.wago.com/210-504)

Nr. articol: 210-505

Steel carrier rail; 35 x 7.5 mm; 1 mm thick; 2 m long; unslotted; galvanized; according to EN 60715

[www.wago.com/210-505](http://www.wago.com/210-505)

Nr. articol: 210-506

Steel carrier rail; 35 x 15 mm; 1.5 mm thick; 2 m long; unslotted; galvanized; similar to EN 60715

[www.wago.com/210-506](http://www.wago.com/210-506)

Nr. articol: 210-508

Steel carrier rail; 35 x 15 mm; 1.5 mm thick; 2 m long; slotted; galvanized; similar to EN 60715

[www.wago.com/210-508](http://www.wago.com/210-508)

## Descărcări

## Documentation

## Additional Information

Technical explanations

Apr 3, 2019

pdf  
2,1 MB

Descărcare

## CAD/CAE-Data

## CAD data

Supus modificărilor.

WAGO Kontakttechnik GmbH & Co. KG  
/Representative Office Romania  
Sos. Pipera-Tunari nr. 1/1  
building 1, 2nd floor | 077190 Voluntari, Ilfov  
Tel.: +40-(0)31 421 85 68 | Email: info-RO@wago.com

Aveți întrebări despre produsele noastre?  
Vă stăm la dispoziție pentru preluarea apelului la +40 (0) 31 421 85 68.

2D/3D Models 284-621

[URL](#)

[Descărcare](#)

#### CAE data

EPLAN Data Portal 284-621

[URL](#)

[Descărcare](#)

WSCAD Universe 284-621

[URL](#)

[Descărcare](#)

## Installation Notes

### Conductor termination

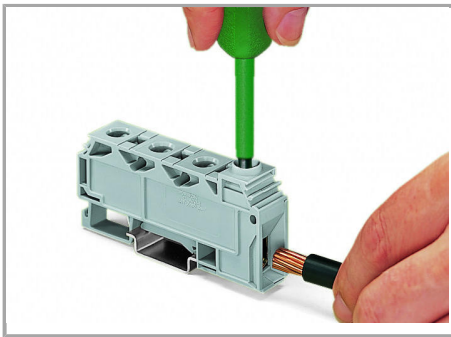

Terminating a 35 mm<sup>2</sup> (2 AWG) conductor –

screw clamp connection, side-entry wiring.

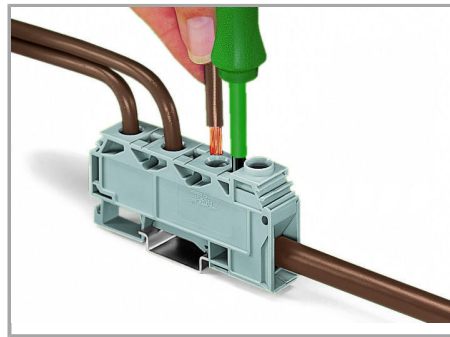

Terminating a 10 mm<sup>2</sup> (8 AWG) conductor –

CAGE CLAMP® connection, front-entry wiring.

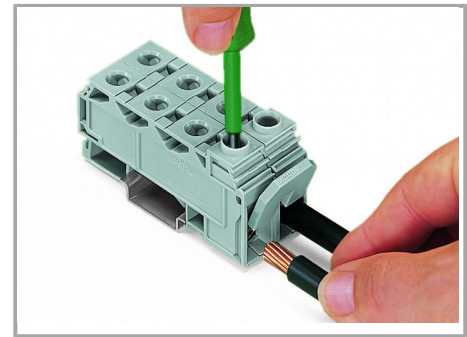

Connecting 35 mm<sup>2</sup> (2 AWG) conductors to commoned terminal blocks.

Screw clamp connection, side-entry wiring

### Commoning

Supus modificărilor.



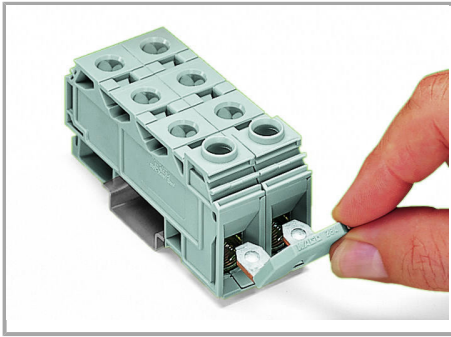

Commoning with comb-style jumper bar.

Individual arrangement: 125 A

Two jumpers combined in one clamping unit:  
100 A

#### Application

Supus modificărilor.

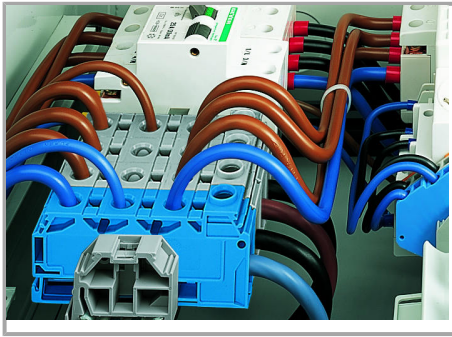

Side-entry distribution terminal block with screw clamp connection (35 mm<sup>2</sup>/2 AWG) and front-entry CAGE CLAMP® connection (3 x 10 mm<sup>2</sup>/8 AWG) snaps onto DIN-35 rails per EN 60715. This terminal block is enclosed on both sides and requires no end or intermediate plate.

When connecting 3 x 10 mm<sup>2</sup> (8 AWG) conductors on the distribution side, make sure that the nominal current of 125 A is not exceeded.

Supus modificărilor.