

Fișă tehnică | Număr articol: 770-620

T-distribution connector; 5-pole; Cod. I; 1 input; 2 outputs; 3 locking levers;
for flying leads; blue

www.wago.com/770-620

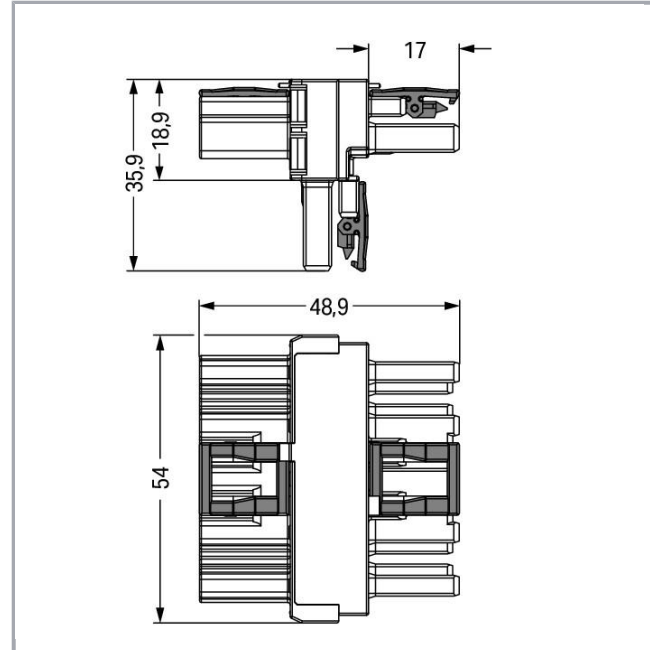
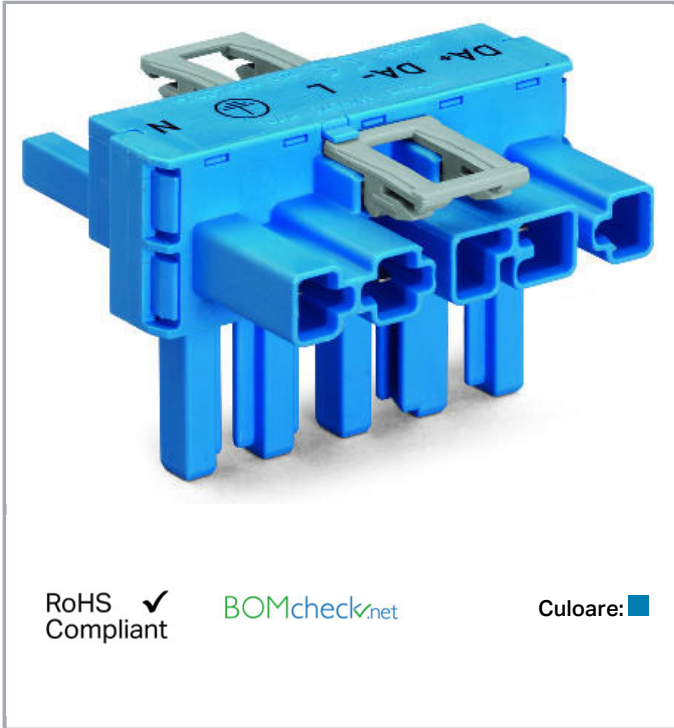

Descriere articol

- Protected against mismatching and maintenance-free
- Additional variable coding is possible

Note:

All connectors for mounted installations (snap-in versions for lighting fixtures or devices, all types of PCB and distribution connectors) are factory-equipped with locking levers to ensure plugs and sockets are securely locked. Additional locking levers are only required for flying leads (plug /socket).

Note on mismatching protection:

All WINSTA[®] components are 100% protected against mismatching when:

- plugging different numbers of poles
- plugging while rotated 180
- plugging while laterally staggered
- plugging one pole

Safety information 1:

Application note for the U.S. market (USR): Some versions may also be used for current interruption in accordance with the UL certificate in select applications with currents below 16 A and voltages up to 600 V. For further information, please contact your local sales office.

Supus modificărilor.

WAGO Kontakttechnik GmbH & Co. KG
/Representative Office Romania
Sos. Pipera-Tunari nr. 1/1
building 1, 2nd floor | 077190 Voluntari, Ilfov
Tel.: +40-(0)31 421 85 68 | Email: info-RO@wago.com

Aveți întrebări despre produsele noastre?

Vă stăm la dispoziție pentru preluarea apelului la +40 (0) 31 421 85 68.

**Date****Electrical data**

| | |
|----------------------------|-----------------------------------------------------------------------------------|
| Note on Contact Resistance | approx. 1 mΩ of contact resistance approx. 0.25 mΩ contact transition plug/socket |
|----------------------------|-----------------------------------------------------------------------------------|

Ratings per IEC/EN 60664-1

| Ratings per | IEC/EN 60664-1 |
|-----------------------------|-----------------------------------------------------------|
| Nominal voltage (III/3) | 400 V |
| Rated surge voltage (III/3) | 6 kV |
| Rated current | 25 A |
| Legend (ratings) | (III / 3) ≙ Overvoltage category III / Pollution degree 3 |

Approvals per UL 1977

| | |
|-----------------------|-------|
| Rated voltage UL 1977 | 600 V |
| Rated current UL 1977 | 23 A |

Connection data

| | |
|----------------------------|-------------------------------|
| Pole No. | 5 |
| Total number of potentials | 5 |
| Ground function | with preceding ground contact |

Geometrical Data

| | |
|-------------|----------------------|
| Pin spacing | 10 mm / 0.394 inch |
| Width | 54 mm / 2.126 inch |
| Height | 35,9 mm / 1.413 inch |
| Depth | 48,9 mm / 1.925 inch |

Mechanical data

| | |
|-----------------------------------------|-------------------------------------------------------------------------------------------------------|
| Technologie | DALI |
| Coding | I |
| Mating force of a plug-in connection | approx. 20 ... 70 N (depending on pole number) |
| Retention force of a plug-in connection | When locked: > 80 N |
| Unmating force of a plug-in connection | when unlocked: approx. 20 ... 70 N (depending on pole number) |
| Number of mating cycles | 200, without resistive load 100, with resistive load $I_N = 25$ A, tested (4 mm ² /AWG 12) |

Supus modificărilor.

WAGO Kontakttechnik GmbH & Co. KG
 /Representative Office Romania
 Sos. Pipera-Tunari nr. 1/1
 building 1, 2nd floor | 077190 Voluntari, Ilfov
 Tel.: +40-(0)31 421 85 68 | Email: info-RO@wago.com

Aveți întrebări despre produsele noastre?
 Vă stăm la dispoziție pentru preluarea apelului la +40 (0) 31 421 85 68.



| | |
|-------------------------|-------------------------------------------------------------------------------------------------------|
| Distributor type | T-distribution connector |
| Marking | N L DA- DA+ |
| Protection type | IP20 |
| Note on protection type | Only when mated (these compact connectors are not designed for use in open, easily accessible areas). |
| Potential marking | N L DA- DA+ |
| Application | Lighting management |
| Suitable | for flying leads |

Plug connection

| | |
|------------------------------------|---------------|
| Contact type (pluggable connector) | Socket/plug |
| Mismating protection | Yes |
| Locking of plug-in connection | locking lever |
| Locking lever | yes |

Material Data

| | |
|---------------------|------------------------------------------|
| Color | blue |
| Insulation material | Polyamide 66 (PA 66) |
| Contact material | Copper or copper alloy (surface-treated) |
| Fire load | 0,466 MJ |
| Weight | 24,8 g |

Environmental Requirements

| | |
|------------------------------------------|-------------------------------------------------|
| Processing temperature | -5 ... +40 °C |
| Continuous operating temperature | -35 ... +85 °C |
| Note on continuous operating temperature | Insulating parts for temperatures ≤ 105 °C |

Commercial data

| | |
|-----------------------|---------------|
| Packaging type | BOX |
| Country of origin | DE |
| GTIN | 4044918934985 |
| Customs tariff number | 85366990990 |

Aprobări / certificate

Country specific Approvals

| Emblemă | Aprobare | Text de aprobare suplimentar | Nume certificat |
|---------|----------|------------------------------|-----------------|
| | | | |

Supus modificărilor.

WAGO Kontakttechnik GmbH & Co. KG
 /Representative Office Romania
 Sos. Pipera-Tunari nr. 1/1
 building 1, 2nd floor | 077190 Voluntari, Ilfov
 Tel.: +40-(0)31 421 85 68 | Email: info-RO@wago.com

Aveți întrebări despre produsele noastre?
 Vă stăm la dispoziție pentru preluarea apelului la +40 (0) 31 421 85 68.





CCA
DEKRA Certification B.V.

EN 61535

2173495.02





Ship Approvals

| Emblemă | Aprobare | Text de aprobare suplimentar | Nume certificat |
|-----------------------------------------------------------------------------------|---------------------------------------------------------|------------------------------|--------------------------|
|  | ABS American Bureau of Shipping | - | 19- HG1868589- PDA |
|  | DNV GL Det Norske Veritas, Germanischer Lloyd | - | TAE00001Z6 |
|  | LR Lloyds Register | IEC 61984 | 02/20050 (E6) |

UL-Approvals

| Emblemă | Aprobare | Text de aprobare suplimentar | Nume certificat |
|------------------------------------------------------------------------------------|------------------------------------------------|------------------------------|------------------|
|  | cURus Underwriters Laboratories Inc. | UL 1977 | E45171 Sec. 9 |

Counterpart

| | | |
|------------------------------------------------------------------------------------|--------------------------------------------------------------------------------------------------------------------------------------------------------------------------------|----------------------------------------------------------------------------------|
|  | Nr. articol770-1105/022-000 Socket; with strain relief housing; 5-pole; Cod. I; 4,00 mm ² ; blue | www.wago.com/770-1105/022-000 |
|  | Nr. articol770-1105 Socket; 5-pole; Cod. I; 4,00 mm ² ; blue | www.wago.com/770-1105 |
|  | Nr. articol770-1115 Plug; 5-pole; Cod. I; 4,00 mm ² ; blue | www.wago.com/770-1115 |
|  | Nr. articol771-9985/006-101 pre-assembled interconnecting cable; Eca; Socket/plug; 5-pole; Cod. I; H05VV-F 5G 1.5 mm ² ; 1 m; 1,50 mm ² ; blue | www.wago.com/771-9985/006-101 |
|  | Nr. articol770-1115/022-000 Plug; with strain relief housing; 5-pole; Cod. I; 4,00 mm ² ; blue | www.wago.com/770-1115/022-000 |
| | Nr. articol771-9985/106-101 | |

Supus modificărilor.

WAGO Kontakttechnik GmbH & Co. KG
/Representative Office Romania
Sos. Pipera-Tunari nr. 1/1
building 1, 2nd floor | 077190 Voluntari, Ilfov
Tel.: +40-(0)31 421 85 68 | Email: info-RO@wago.com

Aveți întrebări despre produsele noastre?
Vă stăm la dispoziție pentru preluarea apelului la +40 (0) 31 421 85 68.



pre-assembled connecting cable; Eca; Socket/open-ended; 5-pole; Cod. I; H05VV-F 5G 1.5 mm²; 1 m; 1,50 mm²; blue

www.wago.com/771-9985/106-101



Nr. articol771-9985/206-101

pre-assembled connecting cable; Eca; Plug/open-ended; 5-pole; Cod. I; H05VV-F 5G 1.5 mm²; 1 m; 1,50 mm²; blue

www.wago.com/771-9985/206-101

Descărcări

CAD/CAE-Data

CAD data

2D/3D Models 770-620

[URL](#)

[Descărcare](#)

CAE data

EPLAN Data Portal 770-620

[URL](#)

[Descărcare](#)

WSCAD Universe 770-620

[URL](#)

[Descărcare](#)

Installation Notes

Installation

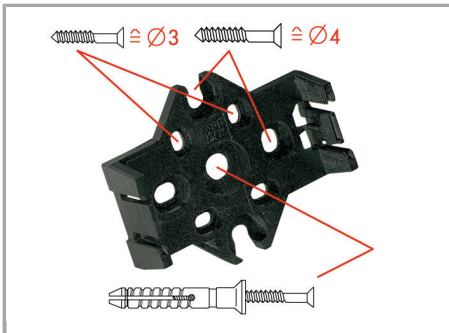

The mounting plate for distribution connectors can be mounted using commercially available screws or nail-drive anchors.



The distribution connectors are latched when mounted on the mounting plate.



To release the distribution connector, unlock the latch using a screwdriver.

Supus modificărilor.

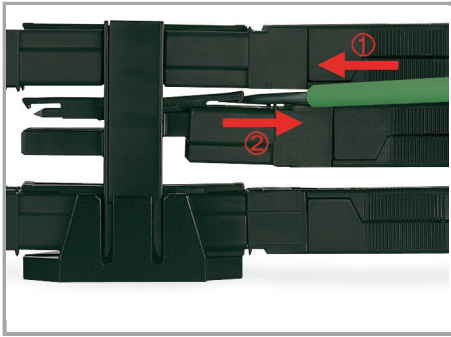

All distributor connections are locked and protected against accidental disconnection directly after mating. Locking of any connection is released using a screwdriver, even if all connections are in use.

Familie de produse

WINSTA® MIDI

Afișare globală produse din familie.

Supus modificărilor.