

Fișă tehnică | Număr articol: 282-870

3-conductor disconnect/test terminal block; e.g., current transformer circuits; with touch-proof test sockets; for 4 mm Ø test plugs; for DIN-rail 35 x 15 and 35 x 7.5; 6 mm²; CAGE CLAMP®; 6,00 mm²; gray

www.wago.com/282-870

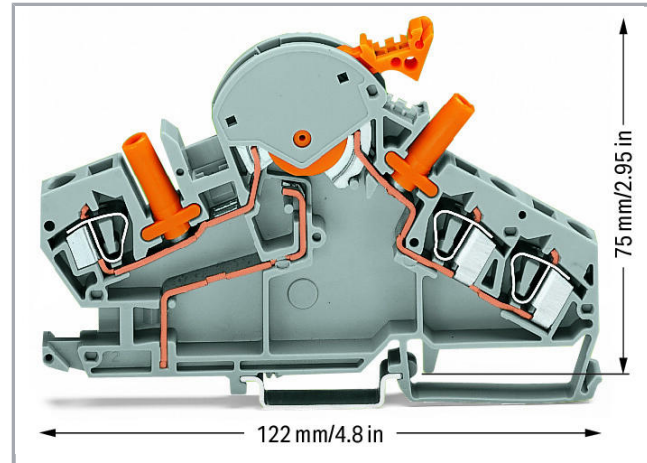
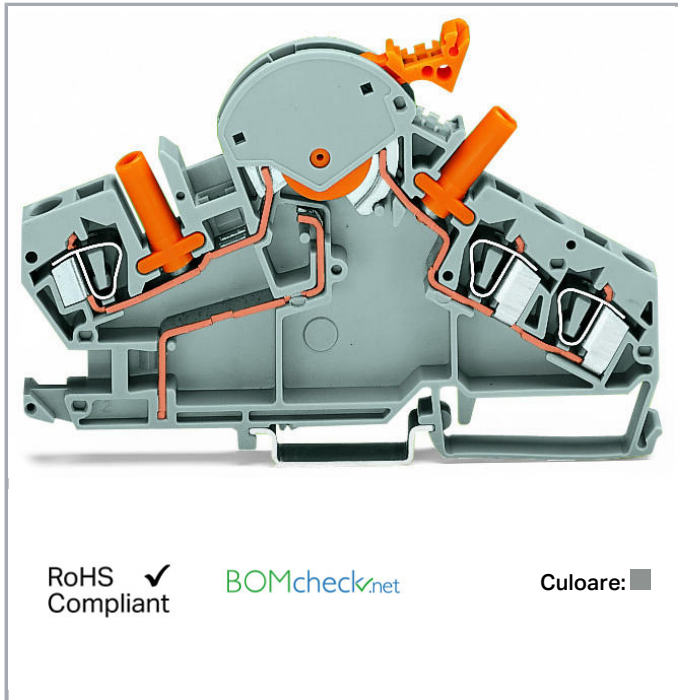

RoHS Compliant

BOMcheck.net

Culoare: ■

Date

Electrical data

Ratings per IEC/EN 60664-1

| | |
|-----------------------------|---|
| Nominal voltage (III/3) | 500 V |
| Rated surge voltage (III/3) | 6 kV |
| Rated current | 30 A |
| Legend (ratings) | (III / 3) ≙ Overvoltage category III / Pollution degree 3 |

Connection data

| | |
|---------------------------------|---|
| Connection technology | CAGE CLAMP® |
| Actuation type | Operating tool |
| Connectable conductor materials | Copper |
| Solid conductor | 0,2 ... 6 mm ² / 24 ... 10 AWG |
| Fine-stranded conductor | 0,2 ... 6 mm ² / 24 ... 10 AWG |

Supus modificărilor.

WAGO Kontakttechnik GmbH & Co. KG
/Representative Office Romania
Sos. Pipera-Tunari nr. 1/1
building 1, 2nd floor | 077190 Voluntari, Ilfov
Tel.: +40-(0)31 421 85 68 | Email: info-RO@wago.com

Aveți întrebări despre produsele noastre?
Vă stăm la dispoziție pentru preluarea apelului la +40 (0) 31 421 85 68.

| | |
|-----------------------------------|-----------------------------------|
| Strip length | 12 ... 13 mm / 0.47 ... 0.51 inch |
| Total number of connection points | 3 |
| Total number of potentials | 2 |
| Number of levels | 1 |
| Wiring type | Front-entry wiring |

Geometrical Data

| | |
|------------------------------------|---------------------|
| Width | 8 mm / 0.315 inch |
| Height from upper-edge of DIN-rail | 75 mm / 2.953 inch |
| Depth | 122 mm / 4.803 inch |

Mechanical data

| | |
|---------------|----------------|
| Design | angled |
| Mounting type | DIN-35 rail |
| Marking level | Center marking |

Material Data

| | |
|---------------------|----------------------|
| Color | gray |
| Insulation material | Polyamide 66 (PA 66) |
| Fire load | 0,688 MJ |
| Weight | 46,8 g |

Commercial data

| | |
|-----------------------|----------------------------------|
| Product Group | 1 (Rail Mounted Terminal Blocks) |
| Packaging type | BOX |
| Country of origin | CN |
| GTIN | 4044918692861 |
| Customs tariff number | 85365080900 |

Aprobări / certificate

Country specific Approvals

| Emblemă | Aprobare | Text de aprobare suplimentar | Nume certificat |
|--|---------------------------------|------------------------------|-----------------|
|  | CCA DEKRA Certification B.V. | EN 60947 | 2195540.01 |

Supus modificărilor.



CCA
DEKRA Certification B.V.

EN 60947

NTR NL-
7522

Ship Approvals

| Emblemă | Aprobare | Text de aprobare suplimentar | Nume certificat |
|--|---|------------------------------|--------------------------|
|  | ABS American Bureau of Shipping | EN 60947 | 20- HG1941090- PDA |
|  | BV Bureau Veritas S.A. | EN 60947 | 07436/E0 BV |
|  | DNV GL Det Norske Veritas, Germanischer Lloyd | - | TAE00001V2 |
|  | LR Lloyds Register | EN 60947 | 91/20112 (E9) |

UL-Approvals

| Emblemă | Aprobare | Text de aprobare suplimentar | Nume certificat |
|--|--|------------------------------|---------------------|
|  | cURus Underwriters Laboratories Inc. | UL 1059 | 20190731- E45172 |

Counterpart







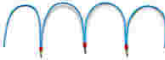

Produse compatibile

Supus modificărilor.







WAGO Kontakttechnik GmbH & Co. KG
/Representative Office Romania
Sos. Pipera-Tunari nr. 1/1
building 1, 2nd floor | 077190 Voluntari, Ilfov
Tel.: +40-(0)31 421 85 68 | Email: info-RO@wago.com

Aveți întrebări despre produsele noastre?
Vă stăm la dispoziție pentru preluarea apelului la +40 (0) 31 421 85 68.

Jumper

| | | |
|--|--|--|
|  | Nr. articol: 210-103 Wire commoning chain; insulated; 50 connections; black | www.wago.com/210-103 |
|  | Nr. articol: 210-123 Wire commoning chain; insulated; 50 connections | www.wago.com/210-123 |
|  | Nr. articol: 282-402 Adjacent jumper; insulated; Nominal current 41 A | www.wago.com/282-402 |
|  | Nr. articol: 282-409 Alternate jumper; insulated; Nominal current 41 A; gray | www.wago.com/282-409 |
|  | Nr. articol: 282-422 Adjacent jumper; insulated; Nominal current 41 A; yellow-green | www.wago.com/282-422 |
|  | Nr. articol: 282-424 Adjacent jumper; insulated; Nominal current 41 A; orange | www.wago.com/282-424 |
|  | Nr. articol: 709-110 Wire commoning chain; insulated; 4 connections; 3 x 110 mm; black | www.wago.com/709-110 |
|  | Nr. articol: 709-111 Wire commoning chain; insulated; 3 connections; 2 x 120 mm; black | www.wago.com/709-111 |
|  | Nr. articol: 709-112 Wire commoning chain; insulated; 3 connections; 2 x 170 mm; black | www.wago.com/709-112 |















Carrier rail

| | | |
|--|---|--|
|  | Nr. articol: 210-112 Steel carrier rail; 35 x 7.5 mm; 1 mm thick; 2 m long; slotted; according to EN 60715; "Hole width 25 mm | www.wago.com/210-112 |
|  | Nr. articol: 210-113 Steel carrier rail; 35 x 7.5 mm; 1 mm thick; 2 m long; unslotted; according to EN 60715 | www.wago.com/210-113 |
|  | Nr. articol: 210-114 Steel carrier rail; 35 x 15 mm; 1.5 mm thick; 2 m long; unslotted; similar to EN 60715 | www.wago.com/210-114 |
|  | Nr. articol: 210-115 Steel carrier rail; 35 x 7.5 mm; 1 mm thick; 2 m long; slotted; according to EN 60715; "Hole width 18 mm | www.wago.com/210-115 |
|  | Nr. articol: 210-118 Steel carrier rail; 35 x 15 mm; 2.3 mm thick; 2 m long; unslotted; according to EN 60715 | www.wago.com/210-118 |
|  | Nr. articol: 210-196 Aluminum carrier rail; 35 x 8.2 mm; 1.6 mm thick; 2 m long; unslotted; similar to EN 60715; silver-colored | www.wago.com/210-196 |

Supus modificărilor.

WAGO Kontakttechnik GmbH & Co. KG
/Representative Office Romania
Sos. Pipera-Tunari nr. 1/1
building 1, 2nd floor | 077190 Voluntari, Ilfov
Tel.: +40-(0)31 421 85 68 | Email: info-RO@wago.com

Aveți întrebări despre produsele noastre?
Vă stăm la dispoziție pentru preluarea apelului la +40 (0) 31 421 85 68.

| | | |
|--|--|--|
|  | Nr. articol: 210-197 Steel carrier rail; 35 x 15 mm; 1.5 mm thick; 2 m long; slotted; similar to EN 60715 | www.wago.com/210-197 |
|  | Nr. articol: 210-198 Copper carrier rail; 35 x 15 mm; 2.3 mm thick; 2 m long; unslotted; according to EN 60715; copper-colored | www.wago.com/210-198 |
|  | Nr. articol: 210-504 Steel carrier rail; 35 x 7.5 mm; 1 mm thick; 2 m long; slotted; galvanized; according to EN 60715 | www.wago.com/210-504 |
|  | Nr. articol: 210-505 Steel carrier rail; 35 x 7.5 mm; 1 mm thick; 2 m long; unslotted; galvanized; according to EN 60715 | www.wago.com/210-505 |
|  | Nr. articol: 210-506 Steel carrier rail; 35 x 15 mm; 1.5 mm thick; 2 m long; unslotted; galvanized; similar to EN 60715 | www.wago.com/210-506 |
|  | Nr. articol: 210-508 Steel carrier rail; 35 x 15 mm; 1.5 mm thick; 2 m long; slotted; galvanized; similar to EN 60715 | www.wago.com/210-508 |
| Marking accessories | | |
|  | Nr. articol: 2009-115 WMB-Inline; for Smart Printer; 1500 pieces on roll; stretchable 5 - 5.2 mm; plain; snap-on type; white | www.wago.com/2009-115 |
|  | Nr. articol: 2009-115/000-002 WMB-Inline; for Smart Printer; 1500 pieces on roll; stretchable 5 - 5.2 mm; plain; snap-on type; yellow | www.wago.com/2009-115/000-002 |
|  | Nr. articol: 2009-115/000-006 WMB-Inline; for Smart Printer; 1500 pieces on roll; stretchable 5 - 5.2 mm; plain; snap-on type; blue | www.wago.com/2009-115/000-006 |
|  | Nr. articol: 2009-115/000-007 WMB-Inline; for Smart Printer; 1500 pieces on roll; stretchable 5 - 5.2 mm; plain; snap-on type; gray | www.wago.com/2009-115/000-007 |
|  | Nr. articol: 2009-115/000-012 WMB-Inline; for Smart Printer; 1500 pieces on roll; stretchable 5 - 5.2 mm; plain; snap-on type; orange | www.wago.com/2009-115/000-012 |
|  | Nr. articol: 2009-115/000-017 WMB-Inline; for Smart Printer; 1500 pieces on roll; stretchable 5 - 5.2 mm; plain; snap-on type; light green | www.wago.com/2009-115/000-017 |
|  | Nr. articol: 2009-115/000-023 WMB-Inline; for Smart Printer; 1500 pieces on roll; stretchable 5 - 5.2 mm; plain; snap-on type; green | www.wago.com/2009-115/000-023 |
|  | Nr. articol: 2009-115/000-024 WMB-Inline; for Smart Printer; 1500 pieces on roll; stretchable 5 - 5.2 mm; plain; snap-on type; violet | www.wago.com/2009-115/000-024 |
|  | Nr. articol: 249-105 Group marker carrier; gray | www.wago.com/249-105 |

Supus modificărilor.



Nr. articol: 249-200
WCB marker tag; 20 markers each tag; plain; snap-on type; white

www.wago.com/249-200



Nr. articol: 793-501
WMB marking card; as card; not stretchable; plain; snap-on type; white

www.wago.com/793-501



Nr. articol: 793-501/000-002
WMB marking card; as card; not stretchable; plain; snap-on type; yellow

www.wago.com/793-501/000-002



Nr. articol: 793-501/000-005
WMB marking card; as card; not stretchable; plain; snap-on type; red

www.wago.com/793-501/000-005



Nr. articol: 793-501/000-006
WMB marking card; as card; not stretchable; plain; snap-on type; blue

www.wago.com/793-501/000-006



Nr. articol: 793-501/000-007
WMB marking card; as card; not stretchable; plain; snap-on type; gray

www.wago.com/793-501/000-007



Nr. articol: 793-501/000-012
WMB marking card; as card; not stretchable; plain; snap-on type; orange

www.wago.com/793-501/000-012



Nr. articol: 793-501/000-017
WMB marking card; as card; not stretchable; plain; snap-on type; light green

www.wago.com/793-501/000-017



Nr. articol: 793-501/000-023
WMB marking card; as card; not stretchable; plain; snap-on type; green

www.wago.com/793-501/000-023



Nr. articol: 793-501/000-024
WMB marking card; as card; not stretchable; plain; snap-on type; violet

www.wago.com/793-501/000-024



Nr. articol: 793-5501
WMB marking card; as card; for terminal block width 5 - 17.5 mm; stretchable 5 - 5.2 mm; plain; snap-on type; white

www.wago.com/793-5501



Nr. articol: 793-5501/000-002
WMB marking card; as card; for terminal block width 5 - 17.5 mm; stretchable 5 - 5.2 mm; plain; snap-on type; yellow

www.wago.com/793-5501/000-002



Nr. articol: 793-5501/000-005
WMB marking card; as card; for terminal block width 5 - 17.5 mm; stretchable 5 - 5.2 mm; plain; snap-on type; red

www.wago.com/793-5501/000-005



Nr. articol: 793-5501/000-006
WMB marking card; as card; for terminal block width 5 - 17.5 mm; stretchable 5 - 5.2 mm; plain; snap-on type; blue

www.wago.com/793-5501/000-006

Supus modificărilor.

**Nr. articol:** 793-5501/000-007

WMB marking card; as card; for terminal block width 5 - 17.5 mm; stretchable 5 - 5.2 mm; plain; snap-on type; gray

www.wago.com/793-5501/000-007**Nr. articol:** 793-5501/000-012

WMB marking card; as card; for terminal block width 5 - 17.5 mm; stretchable 5 - 5.2 mm; plain; snap-on type; orange

www.wago.com/793-5501/000-012**Nr. articol:** 793-5501/000-014

WMB marking card; as card; for terminal block width 5 - 17.5 mm; stretchable 5 - 5.2 mm; plain; snap-on type; brown

www.wago.com/793-5501/000-014**Nr. articol:** 793-5501/000-017

WMB marking card; as card; for terminal block width 5 - 17.5 mm; stretchable 5 - 5.2 mm; plain; snap-on type; green

www.wago.com/793-5501/000-017**Nr. articol:** 793-5501/000-023

WMB marking card; as card; for terminal block width 5 - 17.5 mm; stretchable 5 - 5.2 mm; plain; snap-on type; light green

www.wago.com/793-5501/000-023**Nr. articol:** 793-5501/000-024

WMB marking card; as card; for terminal block width 5 - 17.5 mm; stretchable 5 - 5.2 mm; plain; snap-on type; violet

www.wago.com/793-5501/000-024**Nr. articol:** 794-5553/000-002

WMB marking card; as card; MARKED; k/l (each 50); stretchable 5 - 5.2 mm; Horizontal marking; snap-on type; yellow

www.wago.com/794-5553/000-002

General accessories

**Nr. articol:** 209-143

Group marker carrier; gray

www.wago.com/209-143**Nr. articol:** 209-144

Group marker carrier; gray

www.wago.com/209-144

assembling

**Nr. articol:** 209-106

Mounting carrier; for isolated mounting on DIN 35 rails; gray

www.wago.com/209-106**Nr. articol:** 709-154

Cover; Type 2; suitable for cover carrier, type 2; 1 m long; transparent

www.wago.com/709-154

Coding

**Nr. articol:** 282-384

Lock-out; for disconnect link; yellow

www.wago.com/282-384

















check

**Nr. articol:** 209-170Test plug adapter; 8.3 mm wide; for 4 mm Ø test plugs; suitable for 1.5 mm² - 10 mm² tbs; graywww.wago.com/209-170





ferrule

Nr. articol: 216-262Ferrule; Sleeve for 0.75 mm² / 18 AWG; insulated; electro-tin plated; electrolytic copper; gastightwww.wago.com/216-262

Supus modificărilor.

| | | |
|--|---|--|
|  | crimped; acc. to DIN 46228, Part 4/09.90; gray | |
|  | Nr. articol: 216-263 Ferrule; Sleeve for 1 mm ² / AWG 18; insulated; electro-tin plated; electrolytic copper; gastight crimped; acc. to DIN 46228, Part 4/09.90; red | www.wago.com/216-263 |
|  | Nr. articol: 216-264 Ferrule; Sleeve for 1.5 mm ² / AWG 16; insulated; electro-tin plated; electrolytic copper; gastight crimped; acc. to DIN 46228, Part 4/09.90; black | www.wago.com/216-264 |
|  | Nr. articol: 216-266 Ferrule; Sleeve for 2.5 mm ² / AWG 14; insulated; electro-tin plated; electrolytic copper; gastight crimped; acc. to DIN 46228, Part 4/09.90; blue | www.wago.com/216-266 |
|  | Nr. articol: 216-267 Ferrule; Sleeve for 4 mm ² / AWG 12; insulated; electro-tin plated; electrolytic copper; gastight crimped; acc. to DIN 46228, Part 4/09.90; gray | www.wago.com/216-267 |
| End plate | | |
|  | Nr. articol: 282-386 End and separator plate; 1.5 mm thick; without lock-out seal option; orange | www.wago.com/282-386 |
|  | Nr. articol: 282-387 End and separator plate; 1.5 mm thick; with lock-out seal option; orange | www.wago.com/282-387 |
|  | Nr. articol: 282-391 End and separator plate; 1.5 mm thick; without lock-out seal option; gray | www.wago.com/282-391 |
|  | Nr. articol: 282-392 End and separator plate; 1.5 mm thick; with lock-out seal option; gray | www.wago.com/282-392 |
| protection | | |
|  | Nr. articol: 282-415 Protective warning marker; with high-voltage symbol, black; for 5 terminal blocks; yellow | www.wago.com/282-415 |
| tools | | |
|  | Nr. articol: 210-721 Operating tool; Blade: 5.5 x 0.8 mm; with a partially insulated shaft | www.wago.com/210-721 |
| Locking lever | | |
|  | Nr. articol: 210-254 Interlocking link; mechanically locks multiple links; 1 m long; transparent | www.wago.com/210-254 |
|  | Nr. articol: 282-881 Locking cover; mechanically locks multiple links; 1-pole; transparent | www.wago.com/282-881 |
|  | Nr. articol: 282-882 Locking cover; mechanically locks multiple links; 2-pole; transparent | www.wago.com/282-882 |
|  | Nr. articol: 282-883 Locking cover; mechanically locks multiple links; 3-pole; transparent | www.wago.com/282-883 |
|  | Nr. articol: 282-884 Locking cover; mechanically locks multiple links; 4-pole; transparent | www.wago.com/282-884 |

Supus modificărilor.

| | | |
|--|--|--|
|  | Nr. articol: 282-885 Locking cover; mechanically locks multiple links; 5-pole; transparent | www.wago.com/282-885 |
|  | Nr. articol: 282-886 Locking cover; mechanically locks multiple links; 6-pole; transparent | www.wago.com/282-886 |
|  | Nr. articol: 282-887 Locking cover; mechanically locks multiple links; 7-pole; transparent | www.wago.com/282-887 |
|  | Nr. articol: 282-888 Locking cover; mechanically locks multiple links; 8-pole; transparent | www.wago.com/282-888 |

Descărcări

Documentation

Additional Information

| | | | |
|------------------------|-------------|---------------|------------|
| Technical explanations | Apr 3, 2019 | pdf 2,1 MB | Descărcare |
|------------------------|-------------|---------------|------------|

CAD/CAE-Data

CAD data

| | | |
|----------------------|-----|------------|
| 2D/3D Models 282-870 | URL | Descărcare |
|----------------------|-----|------------|

CAE data

| | | |
|---------------------------|-----|------------|
| EPLAN Data Portal 282-870 | URL | Descărcare |
|---------------------------|-----|------------|

| | | |
|------------------------|-----|------------|
| WSCAD Universe 282-870 | URL | Descărcare |
|------------------------|-----|------------|

Installation Notes

Locking lever

Supus modificărilor.

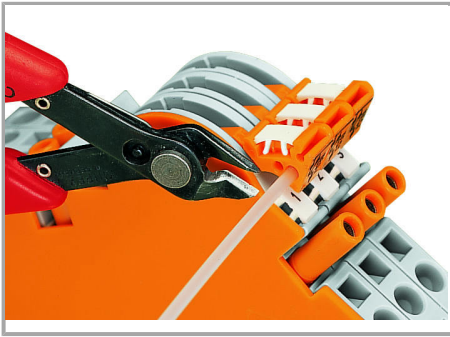

Interlocking link mechanically locks multiple links for multi-pole switching applications.

Marking

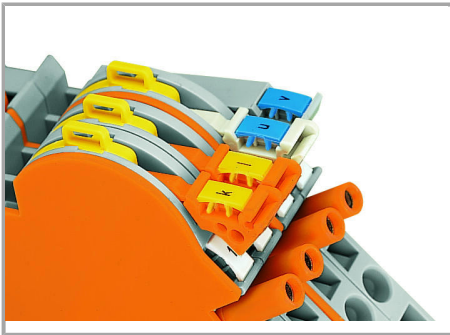

Marking via WMB Multi Marking System.

Supus modificărilor.