

## Fișă tehnică | Număr articol: 2016-1307

3-conductor ground terminal block; 16 mm<sup>2</sup>; suitable for Ex e II applications;  
side and center marking; for DIN-rail 35 x 15 and 35 x 7.5; Push-in CAGE  
CLAMP®; 16,00 mm<sup>2</sup>; green-yellow

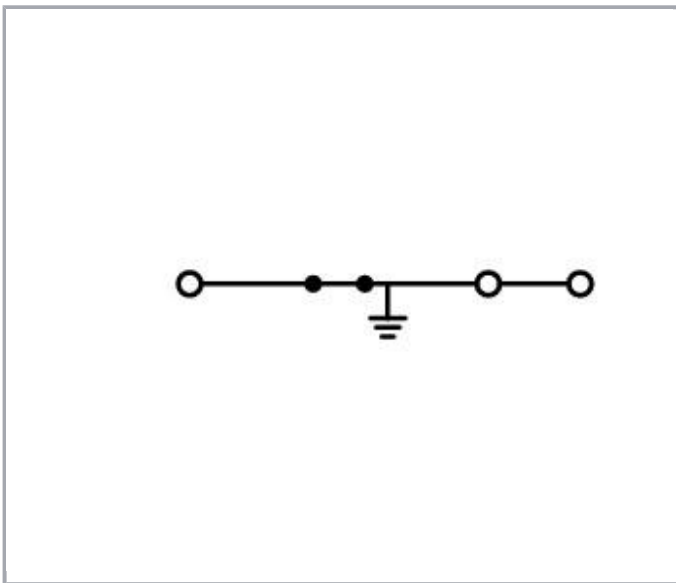

[www.wago.com/2016-1307](http://www.wago.com/2016-1307)

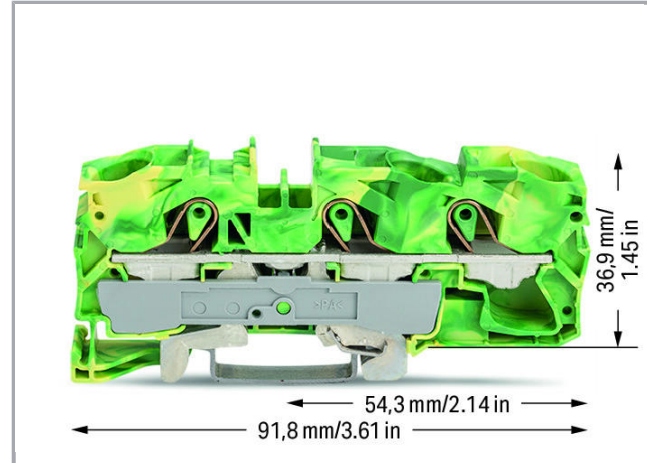
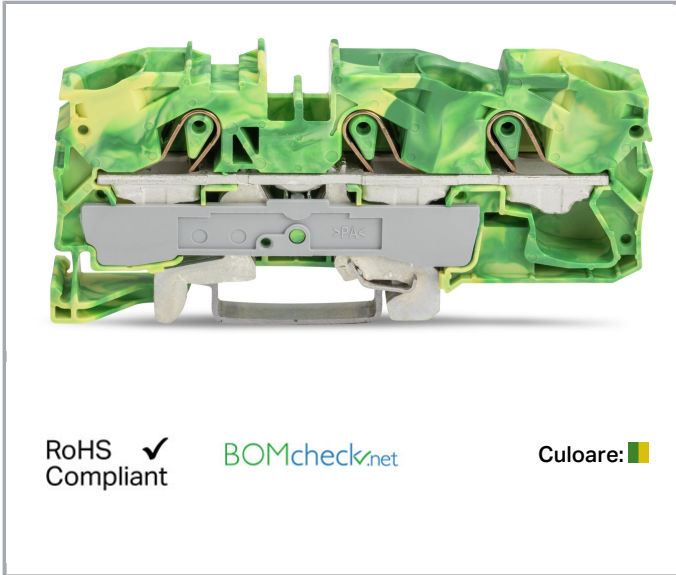

### Descriere articol

#### Safety information 1:

15 mm high DIN-35 rails shall be used for a current load higher than 76 A!

Supus modificărilor.

WAGO Kontakttechnik GmbH & Co. KG  
/Representative Office Romania  
Sos. Pipera-Tunari nr. 1/1  
building 1, 2nd floor | 077190 Voluntari, Ilfov  
Tel.: +40-(0)31 421 85 68 | Email: info-RO@wago.com

Aveți întrebări despre produsele noastre?  
Vă stăm la dispoziție pentru preluarea apelului la +40 (0) 31 421 85 68.

**Date****Electrical data****Ratings per IEC/EN 60664-1**

Ratings per	IEC/EN 60947-7-2
-------------	------------------

**Connection data**

Connection technology	Push-in CAGE CLAMP®
Actuation type	Push-in Open Tool Slot
Connectable conductor materials	Copper
Nominal cross-section	16 mm <sup>2</sup>
Solid conductor	0,5 ... 16 mm <sup>2</sup> / 20 ... 6 AWG
Solid conductor; push-in termination	6 ... 16 mm <sup>2</sup> / 14 ... 6 AWG
Fine-stranded conductor	0,5 ... 25 mm <sup>2</sup> / 20 ... 4 AWG
Fine-stranded conductor; with insulated ferrule	6 ... 16 mm <sup>2</sup> / 10 ... 6 AWG
Fine-stranded conductor; with ferrule; push-in termination	6 ... 16 mm <sup>2</sup> / 10 ... 6 AWG
Strip length	18 ... 20 mm / 0.71 ... 0.79 inch
Total number of connection points	3
Total number of potentials	1
Number of levels	1
Wiring type	Front-entry wiring
Note (conductor cross-section)	Depending on the conductor characteristic, a conductor with a smaller cross-section can also be inserted via push-in termination.
Number of jumper slots	2

**Geometrical Data**

Width	12 mm / 0.472 inch
Height from upper-edge of DIN-rail	36,9 mm / 1.453 inch
Depth	91,8 mm / 3.622 inch

**Mechanical data**

Design	horizontal type
Mounting type	DIN-35 rail
Marking level	Center/side marking

Supus modificărilor.

WAGO Kontakttechnik GmbH & Co. KG  
 /Representative Office Romania  
 Sos. Pipera-Tunari nr. 1/1  
 building 1, 2nd floor | 077190 Voluntari, Ilfov  
 Tel.: +40-(0)31 421 85 68 | Email: info-RO@wago.com

Aveți întrebări despre produsele noastre?  
 Vă stăm la dispoziție pentru preluarea apelului la +40 (0) 31 421 85 68.

## Material Data



Color	green-yellow
Insulation material	Polyamide 66 (PA 66)
Fire load	0,454 MJ
Weight	46,2 g

## Commercial data

Product Group	22 (TOPJOB S)
Packaging type	BOX
Country of origin	DE
GTIN	4017332077200
Customs tariff number	85369010000

## Aprobări / certificate

### Ex-Approvals

Emblemă	Aprobare	Text de aprobare suplimentar	Nume certificat
	<b>AEx</b> UL International Germany GmbH c/o Physikalisch Technische Bundesanstalt	UL 60079	E185892 sec.9
	<b>ATEX</b> Physikalisch Technische Bundesanstalt (PTB)	EN 60079	PTB 05 ATEX 1031 U (II 2 G Ex eII bzw. I M2 Ex eI)
	<b>IECEX</b> Physikalisch Technische Bundesanstalt (PTB)	IEC 60079	IECEX PTB 05.0015 U

### Country specific Approvals

Emblemă	Aprobare	Text de aprobare suplimentar	Nume certificat
	<b>CCA</b> DEKRA Certification B.V.	EN 60947	2172580.01

Supus modificărilor.

WAGO Kontakttechnik GmbH & Co. KG  
/Representative Office Romania  
Sos. Pipera-Tunari nr. 1/1  
building 1, 2nd floor | 077190 Voluntari, Ilfov  
Tel.: +40-(0)31 421 85 68 | Email: info-RO@wago.com

Aveți întrebări despre produsele noastre?  
Vă stăm la dispoziție pentru preluarea apelului la +40 (0) 31 421 85 68.



CCA  
DEKRA Certification B.V.

EN 60947

NTR NL-  
7294







CSA  
DEKRA Certification B.V.

C22.2 No. 158

1579112

### Ship Approvals

Emblemă	Aprobare	Text de aprobare suplimentar	Nume certificat
	<b>ABS</b> American Bureau of Shipping	-	20- HG1941090- PDA
	<b>BV</b> Bureau Veritas S.A.	EN 60947	38586/A0
	<b>DNV GL</b> Det Norske Veritas, Germanischer Lloyd	-	TAE00001V2
	<b>LR</b> Lloyds Register	EN 60947	91/20112 (E9)

### UL-Approvals

Emblemă	Aprobare	Text de aprobare suplimentar	Nume certificat
	<b>UL</b> UL International Germany GmbH	UL 1059	E45172

### Counterpart

### Produse compatibile

Supus modificărilor.

WAGO Kontakttechnik GmbH & Co. KG  
/Representative Office Romania  
Sos. Pipera-Tunari nr. 1/1  
building 1, 2nd floor | 077190 Voluntari, Ilfov  
Tel.: +40-(0)31 421 85 68 | Email: info-RO@wago.com

Aveți întrebări despre produsele noastre?  
Vă stăm la dispoziție pentru preluarea apelului la +40 (0) 31 421 85 68.

## General accessories

**Nr. articol: 2016-100**

Finger guard; touchproof cover protects unused conductor entries; yellow

[www.wago.com/2016-100](http://www.wago.com/2016-100)

## Marking accessories

**Nr. articol: 2009-110**

Marking strips; on reel; not stretchable; plain; snap-on type; white

[www.wago.com/2009-110](http://www.wago.com/2009-110)**Nr. articol: 2009-115**

WMB-Inline; for Smart Printer; 1500 pieces on roll; stretchable 5 - 5.2 mm; plain; snap-on type; white

[www.wago.com/2009-115](http://www.wago.com/2009-115)**Nr. articol: 2009-115/000-002**

WMB-Inline; for Smart Printer; 1500 pieces on roll; stretchable 5 - 5.2 mm; plain; snap-on type; yellow

[www.wago.com/2009-115/000-002](http://www.wago.com/2009-115/000-002)**Nr. articol: 2009-115/000-006**

WMB-Inline; for Smart Printer; 1500 pieces on roll; stretchable 5 - 5.2 mm; plain; snap-on type; blue

[www.wago.com/2009-115/000-006](http://www.wago.com/2009-115/000-006)**Nr. articol: 2009-115/000-007**

WMB-Inline; for Smart Printer; 1500 pieces on roll; stretchable 5 - 5.2 mm; plain; snap-on type; gray

[www.wago.com/2009-115/000-007](http://www.wago.com/2009-115/000-007)**Nr. articol: 2009-115/000-012**

WMB-Inline; for Smart Printer; 1500 pieces on roll; stretchable 5 - 5.2 mm; plain; snap-on type; orange

[www.wago.com/2009-115/000-012](http://www.wago.com/2009-115/000-012)**Nr. articol: 2009-115/000-017**

WMB-Inline; for Smart Printer; 1500 pieces on roll; stretchable 5 - 5.2 mm; plain; snap-on type; light green

[www.wago.com/2009-115/000-017](http://www.wago.com/2009-115/000-017)**Nr. articol: 2009-115/000-023**

WMB-Inline; for Smart Printer; 1500 pieces on roll; stretchable 5 - 5.2 mm; plain; snap-on type; green

[www.wago.com/2009-115/000-023](http://www.wago.com/2009-115/000-023)**Nr. articol: 2009-115/000-024**

WMB-Inline; for Smart Printer; 1500 pieces on roll; stretchable 5 - 5.2 mm; plain; snap-on type; violet

[www.wago.com/2009-115/000-024](http://www.wago.com/2009-115/000-024)**Nr. articol: 2009-145**















Mini-WSB Inline; for Smart Printer; 1700 pieces on roll; stretchable 5 - 5.2 mm; plain; snap-on type; white

[www.wago.com/2009-145](http://www.wago.com/2009-145)**Nr. articol: 2009-145/000-002**

Mini-WSB Inline; for Smart Printer; 1700 pieces on roll; stretchable 5 - 5.2 mm; plain; snap-on type; yellow

[www.wago.com/2009-145/000-002](http://www.wago.com/2009-145/000-002)

Supus modificărilor.

	<b>Nr. articol: 2009-145/000-005</b> Mini-WSB Inline; for Smart Printer; 1700 pieces on roll; stretchable 5 - 5.2 mm; plain; snap-on type; red /000-005	<a href="http://www.wago.com/2009-145/000-005">www.wago.com/2009-145/000-005</a>
	<b>Nr. articol: 2009-145/000-006</b> Mini-WSB Inline; for Smart Printer; 1700 pieces on roll; stretchable 5 - 5.2 mm; plain; snap-on type; blue	<a href="http://www.wago.com/2009-145/000-006">www.wago.com/2009-145/000-006</a>
	<b>Nr. articol: 2009-145/000-007</b> Mini-WSB Inline; for Smart Printer; 1700 pieces on roll; stretchable 5 - 5.2 mm; plain; snap-on type; gray	<a href="http://www.wago.com/2009-145/000-007">www.wago.com/2009-145/000-007</a>
	<b>Nr. articol: 2009-145/000-012</b> Mini-WSB Inline; for Smart Printer; 1700 pieces on roll; stretchable 5 - 5.2 mm; plain; snap-on type; orange	<a href="http://www.wago.com/2009-145/000-012">www.wago.com/2009-145/000-012</a>
	<b>Nr. articol: 2009-145/000-023</b> Mini-WSB Inline; for Smart Printer; 1700 pieces on roll; stretchable 5 - 5.2 mm; plain; snap-on type; green	<a href="http://www.wago.com/2009-145/000-023">www.wago.com/2009-145/000-023</a>
	<b>Nr. articol: 2009-145/000-024</b> Mini-WSB Inline; for Smart Printer; 1700 pieces on roll; stretchable 5 - 5.2 mm; plain; snap-on type; violet	<a href="http://www.wago.com/2009-145/000-024">www.wago.com/2009-145/000-024</a>
	<b>Nr. articol: 2009-191</b> Group marker carrier	<a href="http://www.wago.com/2009-191">www.wago.com/2009-191</a>
	<b>Nr. articol: 2009-192</b> Group marker carrier	<a href="http://www.wago.com/2009-192">www.wago.com/2009-192</a>
	<b>Nr. articol: 2009-193</b> Group marker carrier	<a href="http://www.wago.com/2009-193">www.wago.com/2009-193</a>
	<b>Nr. articol: 2009-198</b> Adaptor	<a href="http://www.wago.com/2009-198">www.wago.com/2009-198</a>
	<b>Nr. articol: 248-501</b> Miniature WSB Quick marking system; plain; Marker width 5 mm; 10 strips with 10 markers per card	<a href="http://www.wago.com/248-501">www.wago.com/248-501</a>
	<b>Nr. articol: 248-501/000-002</b> Mini-WSB marking card; as card; not stretchable; plain; snap-on type; yellow	<a href="http://www.wago.com/248-501/000-002">www.wago.com/248-501/000-002</a>
	<b>Nr. articol: 248-501/000-005</b> Mini-WSB marking card; as card; not stretchable; plain; snap-on type; red	<a href="http://www.wago.com/248-501/000-005">www.wago.com/248-501/000-005</a>
	<b>Nr. articol: 248-501/000-006</b> Mini-WSB marking card; as card; not stretchable; plain; snap-on type; blue	<a href="http://www.wago.com/248-501/000-006">www.wago.com/248-501/000-006</a>

Supus modificărilor.



**Nr. articol:** 248-501/000-007

Mini-WSB marking card; as card; not stretchable; plain; snap-on type; gray

[www.wago.com/248-501/000-007](http://www.wago.com/248-501/000-007)



**Nr. articol:** 248-501/000-012

Mini-WSB marking card; as card; not stretchable; plain; snap-on type; orange

[www.wago.com/248-501/000-012](http://www.wago.com/248-501/000-012)



**Nr. articol:** 248-501/000-017

Mini-WSB marking card; as card; not stretchable; plain; snap-on type; light green

[www.wago.com/248-501/000-017](http://www.wago.com/248-501/000-017)



**Nr. articol:** 248-501/000-023

Mini-WSB marking card; as card; not stretchable; plain; snap-on type; green

[www.wago.com/248-501/000-023](http://www.wago.com/248-501/000-023)



**Nr. articol:** 248-501/000-024

Mini-WSB marking card; as card; not stretchable; plain; snap-on type; violet

[www.wago.com/248-501/000-024](http://www.wago.com/248-501/000-024)



**Nr. articol:** 793-501

WMB marking card; as card; not stretchable; plain; snap-on type; white

[www.wago.com/793-501](http://www.wago.com/793-501)



**Nr. articol:** 793-501/000-002

WMB marking card; as card; not stretchable; plain; snap-on type; yellow

[www.wago.com/793-501/000-002](http://www.wago.com/793-501/000-002)



**Nr. articol:** 793-501/000-005

WMB marking card; as card; not stretchable; plain; snap-on type; red

[www.wago.com/793-501/000-005](http://www.wago.com/793-501/000-005)



**Nr. articol:** 793-501/000-006

WMB marking card; as card; not stretchable; plain; snap-on type; blue

[www.wago.com/793-501/000-006](http://www.wago.com/793-501/000-006)



**Nr. articol:** 793-501/000-007

WMB marking card; as card; not stretchable; plain; snap-on type; gray

[www.wago.com/793-501/000-007](http://www.wago.com/793-501/000-007)



**Nr. articol:** 793-501/000-012

WMB marking card; as card; not stretchable; plain; snap-on type; orange

[www.wago.com/793-501/000-012](http://www.wago.com/793-501/000-012)



**Nr. articol:** 793-501/000-017

WMB marking card; as card; not stretchable; plain; snap-on type; light green

[www.wago.com/793-501/000-017](http://www.wago.com/793-501/000-017)



**Nr. articol:** 793-501/000-023

WMB marking card; as card; not stretchable; plain; snap-on type; green

[www.wago.com/793-501/000-023](http://www.wago.com/793-501/000-023)

Supus modificărilor.

WAGO Kontakttechnik GmbH & Co. KG  
/Representative Office Romania  
Sos. Pipera-Tunari nr. 1/1  
building 1, 2nd floor | 077190 Voluntari, Ilfov  
Tel.: +40-(0)31 421 85 68 | Email: [info-RO@wago.com](mailto:info-RO@wago.com)

Aveți întrebări despre produsele noastre?  
Vă stăm la dispoziție pentru preluarea apelului la +40 (0) 31 421 85 68.



**Nr. articol: 793-501/000-024**  
WMB marking card; as card; not stretchable; plain; snap-on type; violet

[www.wago.com/793-501/000-024](http://www.wago.com/793-501/000-024)



**Nr. articol: 793-5501**  
WMB marking card; as card; for terminal block width 5 - 17.5 mm; stretchable 5 - 5.2 mm; plain; snap-on type; white

[www.wago.com/793-5501](http://www.wago.com/793-5501)



**Nr. articol: 793-5501/000-002**  
WMB marking card; as card; for terminal block width 5 - 17.5 mm; stretchable 5 - 5.2 mm; plain; snap-on type; yellow

[www.wago.com/793-5501/000-002](http://www.wago.com/793-5501/000-002)



**Nr. articol: 793-5501/000-005**  
WMB marking card; as card; for terminal block width 5 - 17.5 mm; stretchable 5 - 5.2 mm; plain; snap-on type; red

[www.wago.com/793-5501/000-005](http://www.wago.com/793-5501/000-005)



**Nr. articol: 793-5501/000-006**  
WMB marking card; as card; for terminal block width 5 - 17.5 mm; stretchable 5 - 5.2 mm; plain; snap-on type; blue

[www.wago.com/793-5501/000-006](http://www.wago.com/793-5501/000-006)



**Nr. articol: 793-5501/000-007**  
WMB marking card; as card; for terminal block width 5 - 17.5 mm; stretchable 5 - 5.2 mm; plain; snap-on type; gray

[www.wago.com/793-5501/000-007](http://www.wago.com/793-5501/000-007)



**Nr. articol: 793-5501/000-012**  
WMB marking card; as card; for terminal block width 5 - 17.5 mm; stretchable 5 - 5.2 mm; plain; snap-on type; orange

[www.wago.com/793-5501/000-012](http://www.wago.com/793-5501/000-012)



**Nr. articol: 793-5501/000-017**  
WMB marking card; as card; for terminal block width 5 - 17.5 mm; stretchable 5 - 5.2 mm; plain; snap-on type; green

[www.wago.com/793-5501/000-017](http://www.wago.com/793-5501/000-017)



**Nr. articol: 793-5501/000-023**  
WMB marking card; as card; for terminal block width 5 - 17.5 mm; stretchable 5 - 5.2 mm; plain; snap-on type; light green

[www.wago.com/793-5501/000-023](http://www.wago.com/793-5501/000-023)



**Nr. articol: 793-5501/000-024**  
WMB marking card; as card; for terminal block width 5 - 17.5 mm; stretchable 5 - 5.2 mm; plain; snap-on type; violet

[www.wago.com/793-5501/000-024](http://www.wago.com/793-5501/000-024)

#### check



**Nr. articol: 2009-174**  
Test plug adapter; for 4 mm Ø test plugs; for testing TOPJOB®S rail-mounted terminal blocks; gray

[www.wago.com/2009-174](http://www.wago.com/2009-174)



**Nr. articol: 2009-182**  
Testing tap; for max. 2.5 mm<sup>2</sup>; tool-free connection for individual test wires 0.08 - 2.5 mm; gray

[www.wago.com/2009-182](http://www.wago.com/2009-182)



**Nr. articol: 2016-511**  
Modular TOPJOB®S connector; modular; for jumper contact slot; 1-pole; 16,00 mm<sup>2</sup>; gray

[www.wago.com/2016-511](http://www.wago.com/2016-511)



**Nr. articol: 2016-549**  
Spacer module; modular; e.g., for bridging commoned terminal blocks; gray

[www.wago.com/2016-549](http://www.wago.com/2016-549)

#### tools

Supus modificărilor.



**Nr. articol: 210-721**

Operating tool; Blade: 5.5 x 0.8 mm; with a partially insulated shaft

[www.wago.com/210-721](http://www.wago.com/210-721)**Jumper****Nr. articol: 2016-402**

Push-in type jumper bar; insulated; 2-way; Nominal current 76 A; light gray

[www.wago.com/2016-402](http://www.wago.com/2016-402)**Nr. articol: 2016-403**

Push-in type jumper bar; insulated; 3-way; Nominal current 76 A; light gray

[www.wago.com/2016-403](http://www.wago.com/2016-403)**Nr. articol: 2016-404**

Push-in type jumper bar; insulated; 4-way; Nominal current 76 A; light gray

[www.wago.com/2016-404](http://www.wago.com/2016-404)**Nr. articol: 2016-405**

Push-in type jumper bar; insulated; 5-way; Nominal current 76 A; light gray

[www.wago.com/2016-405](http://www.wago.com/2016-405)**Nr. articol: 2016-405/011-000**

Star point jumper; insulated; 3-way (1-3-5); IN = IN terminal block; light gray

[www.wago.com/2016-405/011-000](http://www.wago.com/2016-405/011-000)**Nr. articol: 2016-433**

Push-in type jumper bar; insulated; from 1 to 3; Nominal current 76 A; light gray

[www.wago.com/2016-433](http://www.wago.com/2016-433)**Nr. articol: 2016-434**

Push-in type jumper bar; insulated; from 1 to 4; Nominal current 76 A; light gray

[www.wago.com/2016-434](http://www.wago.com/2016-434)**Nr. articol: 2016-435**

Push-in type jumper bar; insulated; from 1 to 5; Nominal current 76 A; light gray

[www.wago.com/2016-435](http://www.wago.com/2016-435)**Nr. articol: 2016-499**Step-down jumper; insulated; from 16/10 mm<sup>2</sup> to 10/6/4/2.5 mm<sup>2</sup>; Nominal current 57 A; light gray[www.wago.com/2016-499](http://www.wago.com/2016-499)**Nr. articol: 210-123**

Wire commoning chain; insulated; 50 connections

[www.wago.com/210-123](http://www.wago.com/210-123)**Carrier rail****Nr. articol: 210-114**

Steel carrier rail; 35 x 15 mm; 1.5 mm thick; 2 m long; unslotted; similar to EN 60715

[www.wago.com/210-114](http://www.wago.com/210-114)**Nr. articol: 210-118**

Steel carrier rail; 35 x 15 mm; 2.3 mm thick; 2 m long; unslotted; according to EN 60715

[www.wago.com/210-118](http://www.wago.com/210-118)**Nr. articol: 210-196**

Aluminum carrier rail; 35 x 8.2 mm; 1.6 mm thick; 2 m long; unslotted; similar to EN 60715; silver-colored

[www.wago.com/210-196](http://www.wago.com/210-196)**Nr. articol: 210-197**

Steel carrier rail; 35 x 15 mm; 1.5 mm thick; 2 m long; slotted; similar to EN 60715

[www.wago.com/210-197](http://www.wago.com/210-197)**Nr. articol: 210-198**











Copper carrier rail; 35 x 15 mm; 2.3 mm thick; 2 m long; unslotted; according to EN 60715; copper-colored

[www.wago.com/210-198](http://www.wago.com/210-198)**End plate**

Supus modificărilor.

WAGO Kontakttechnik GmbH & Co. KG  
 /Representative Office Romania  
 Sos. Pipera-Tunari nr. 1/1  
 building 1, 2nd floor | 077190 Voluntari, Ilfov  
 Tel.: +40-(0)31 421 85 68 | Email: info-RO@wago.com

Aveți întrebări despre produsele noastre?  
 Vă stăm la dispoziție pentru preluarea apelului la +40 (0) 31 421 85 68.

	<b>Nr. articol: 2016-1391</b> End and intermediate plate; 1 mm thick; gray	<a href="http://www.wago.com/2016-1391">www.wago.com/2016-1391</a>
	<b>Nr. articol: 2016-1392</b> End and intermediate plate; 1 mm thick; orange	<a href="http://www.wago.com/2016-1392">www.wago.com/2016-1392</a>
	<b>Nr. articol: 209-191</b> Separator for Ex e/Ex i applications; 3 mm thick; 120 mm wide; orange	<a href="http://www.wago.com/209-191">www.wago.com/209-191</a>
<b>ferrule</b>		
	<b>Nr. articol: 216-210</b> Ferrule; Sleeve for 16 mm <sup>2</sup> / AWG 6; insulated; electro-tin plated; electrolytic copper; gastight crimped; acc. to DIN 46228, Part 4/09.90; blue	<a href="http://www.wago.com/216-210">www.wago.com/216-210</a>
	<b>Nr. articol: 216-284</b> Ferrule; Sleeve for 1.5 mm <sup>2</sup> / AWG 16; insulated; electro-tin plated; electrolytic copper; gastight crimped; acc. to DIN 46228, Part 4/09.90; black	<a href="http://www.wago.com/216-284">www.wago.com/216-284</a>
	<b>Nr. articol: 216-286</b> Ferrule; Sleeve for 2.5 mm <sup>2</sup> / AWG 14; insulated; electro-tin plated; electrolytic copper; gastight crimped; acc. to DIN 46228, Part 4/09.90; blue	<a href="http://www.wago.com/216-286">www.wago.com/216-286</a>
	<b>Nr. articol: 216-287</b> Ferrule; Sleeve for 4 mm <sup>2</sup> / AWG 12; insulated; electro-tin plated; electrolytic copper; gastight crimped; acc. to DIN 46228, Part 4/09.90; gray	<a href="http://www.wago.com/216-287">www.wago.com/216-287</a>
	<b>Nr. articol: 216-288</b> Ferrule; Sleeve for 6 mm <sup>2</sup> / AWG 10; insulated; electro-tin plated; electrolytic copper; gastight crimped; acc. to DIN 46228, Part 4/09.90; yellow	<a href="http://www.wago.com/216-288">www.wago.com/216-288</a>
	<b>Nr. articol: 216-289</b> Ferrule; Sleeve for 10 mm <sup>2</sup> / AWG 8; insulated; electro-tin plated; electrolytic copper; gastight crimped; acc. to DIN 46228, Part 4/09.90; red	<a href="http://www.wago.com/216-289">www.wago.com/216-289</a>
<b>Protective Warning Marker</b>		
	<b>Nr. articol: 2016-115</b> Protective warning marker; with high-voltage symbol, black; for 5 terminal blocks; yellow	<a href="http://www.wago.com/2016-115">www.wago.com/2016-115</a>

## Descărcări

### Documentation

#### Additional Information

Technical explanations	Apr 3, 2019	pdf 2,1 MB	Descărcare
------------------------	-------------	---------------	------------

### CAD/CAE-Data

#### CAD data

2D/3D Models 2016-1307	URL	Descărcare
------------------------	-----	------------

#### CAE data

Supus modificărilor.

WAGO Kontakttechnik GmbH & Co. KG  
/Representative Office Romania  
Sos. Pipera-Tunari nr. 1/1  
building 1, 2nd floor | 077190 Voluntari, Ilfov  
Tel.: +40-(0)31 421 85 68 | Email: info-RO@wago.com

Aveți întrebări despre produsele noastre?  
Vă stăm la dispoziție pentru preluarea apelului la +40 (0) 31 421 85 68.

## Installation Notes

### Conductor termination

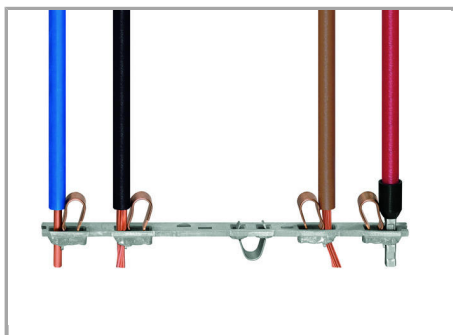

All conductor types at a glance

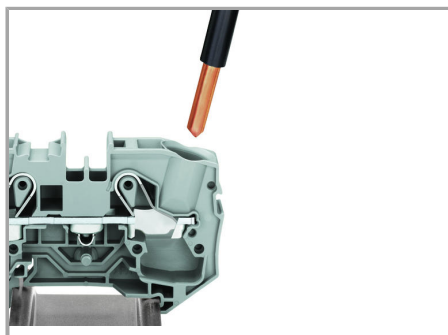

Inserting conductors via push-in termination.

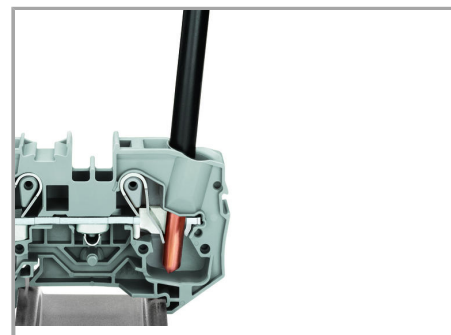

Solid conductors with cross-sections from either one size above, or up to two sizes below, the rated cross-section can be simply pushed in – no tools needed.

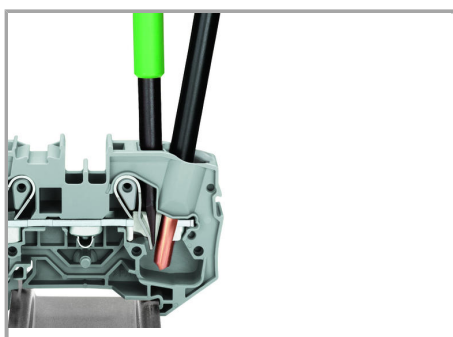

Removing a conductor.

Conductor removal is performed with an operating tool, just like CAGE CLAMP®.

Supus modificărilor.

### Commoning

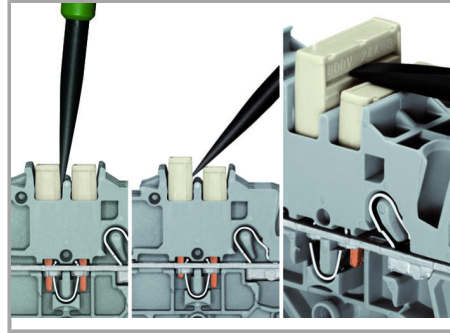
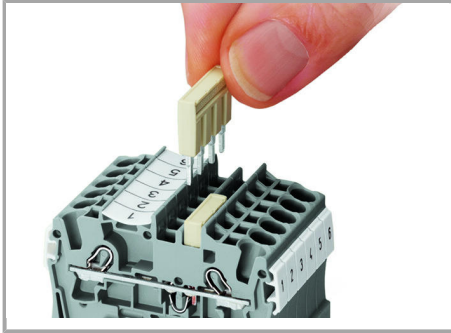

The push-in type jumper bar system is based on the common plug and socket principle. Each terminal block is spring-loaded with a double socket and a resilient CrNi steel spring. The jumper contact material is pure electrolytic copper, which allows for an extremely small design capable of carrying the full-rated current of the terminal block. Ground terminal blocks can also be commoned using the same jumper system. Custom jumpers are created by breaking and removing jumper contacts (2000, 2001, 2002, 2004 Series).

### Removing a push-in type jumper bar.

Insert the operating tool between the jumper and the partition wall of the dual jumper slots, then lift up the jumper.

Place the operating tool in the center of jumpers up to five contacts (see above), or alternately on both sides for jumpers with more than five contacts.

### Testing

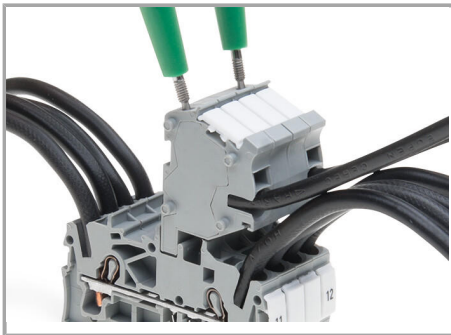

TOPJOB® S Connectors with a 2 mm Ø test socket for testing voltage via 2-pole voltage tester

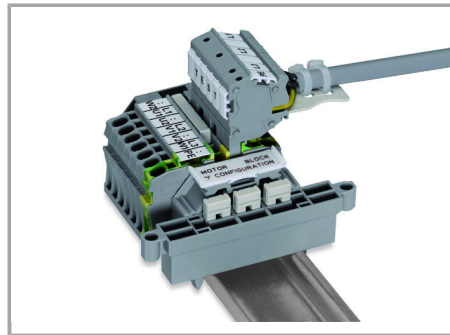

Rail-mount terminal block assembly for electric motor wiring

### Marking

Supus modificărilor.

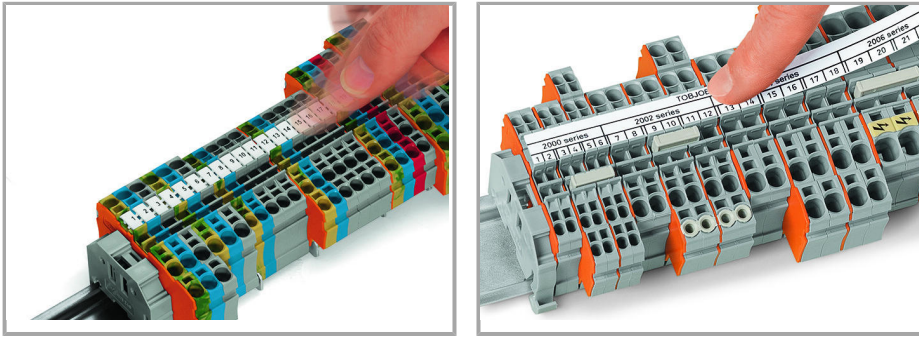

Snapping WMB Inline markers into marker slots.

## Familie de produse

### TOPJOB® S

TOPJOB® S: In various industrial applications and modern building installations, WAGO's wide and versatile range of rail-mount terminal blocks provides more than just reliable electrical connections.

[Afișare globală produse din familie.](#)

Supus modificărilor.

WAGO Kontakttechnik GmbH & Co. KG  
/Representative Office Romania  
Sos. Pipera-Tunari nr. 1/1  
building 1, 2nd floor | 077190 Voluntari, Ilfov  
Tel.: +40-(0)31 421 85 68 | Email: [info-RO@wago.com](mailto:info-RO@wago.com)

Aveți întrebări despre produsele noastre?  
Vă stăm la dispoziție pentru preluarea apelului la +40 (0) 31 421 85 68.