

Fișă tehnică | Număr articol: 2002-2408

4-conductor double deck terminal block; 8-conductor through terminal block; L; without marker carrier; internal commoning; conductor entry with violet marking; for DIN-rail 35 x 15 and 35 x 7.5; 2.5 mm²; Push-in CAGE CLAMP®; 2,50 mm²; gray

www.wago.com/2002-2408

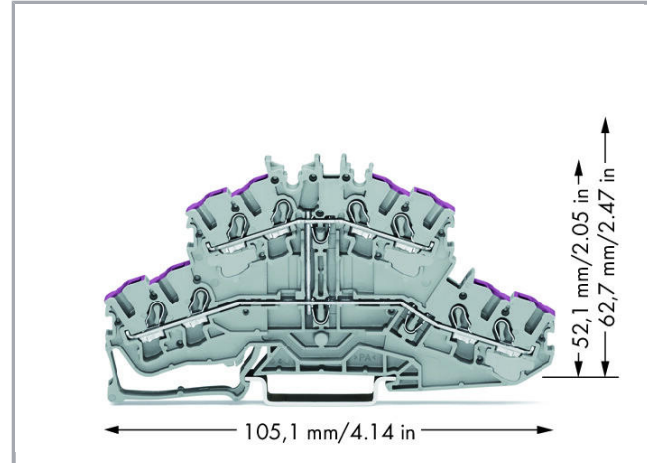
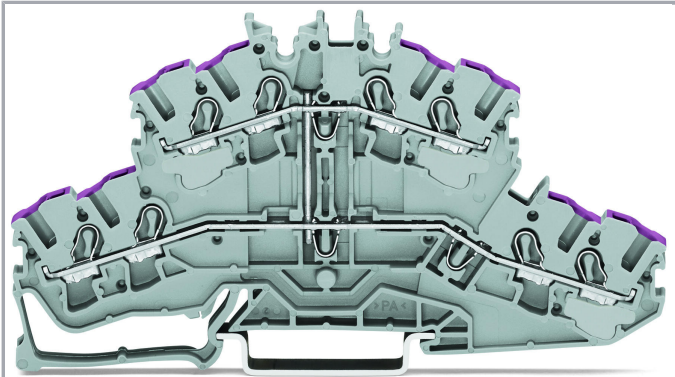

RoHS
Compliant ✓

[BOMcheck.net](https://www.bomcheck.net)

Culoare: ■

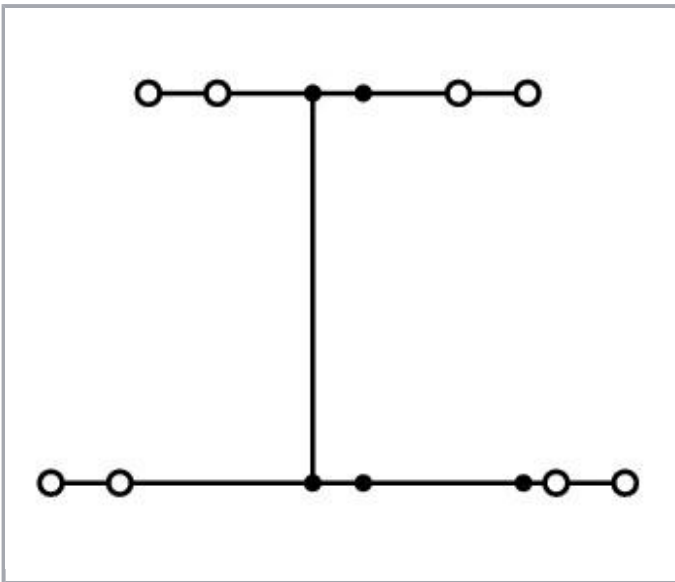

Date

Electrical data

Supus modificărilor.

WAGO Kontakttechnik GmbH & Co. KG
/Representative Office Romania
Sos. Pipera-Tunari nr. 1/1
building 1, 2nd floor | 077190 Voluntari, Ilfov
Tel.: +40-(0)31 421 85 68 | Email: info-RO@wago.com

Aveți întrebări despre produsele noastre?

Vă stăm la dispoziție pentru preluarea apelului la +40 (0) 31 421 85 68.

Ratings per IEC/EN 60664-1

Ratings per	IEC/EN 60947-7-1
Nominal voltage (III/3)	800 V
Rated surge voltage (III/3)	8 kV
Rated current	24 A
Rated current 2	28 A
Legend (ratings)	(III / 3) $\hat{=}$ Overvoltage category III / Pollution degree 3

Approvals per UL 1059

Rated voltage UL (Use Group B)	600 V
Rated current UL (Use Group B)	20 A
Rated voltage UL (Use Group C)	600 V
Rated current UL (Use Group C)	20 A
Approvals per	UL 1059

Connection data

Connection technology	Push-in CAGE CLAMP®
Actuation type	Push-in Open Tool Slot
Connectable conductor materials	Copper
Nominal cross-section	2,5 mm ²
Solid conductor	0,25 ... 4 mm ² / 22 ... 12 AWG
Solid conductor; push-in termination	0,75 ... 4 mm ² / 18 ... 12 AWG
Fine-stranded conductor	0,25 ... 4 mm ² / 22 ... 12 AWG
Fine-stranded conductor; with insulated ferrule	1 ... 2,5 mm ² / 18 ... 12 AWG
Fine-stranded conductor; with ferrule; push-in termination	1 ... 2,5 mm ² / 18 ... 12 AWG
Strip length	10 ... 12 mm / 0.39 ... 0.47 inch
Total number of connection points	8
Total number of potentials	1
Number of levels	2
Wiring type	Front-entry wiring
Note (conductor cross-section)	Depending on the conductor characteristic, a conductor with a smaller cross-section can also be inserted via push-in termination.

Supus modificărilor.

Geometrical Data

Width	5,2 mm / 0.205 inch
Height from upper-edge of DIN-rail	52,1 mm / 2.051 inch
Depth	105,1 mm / 4.138 inch

Mechanical data

Design	horizontal type
Mounting type	DIN-35 rail
Potential marking	L
Marking level	Center/side marking

Material Data



Color	gray
Insulation material	Polyamide 66 (PA 66)
Fire load	0,294 MJ
Weight	16,1 g

Commercial data

Product Group	22 (TOPJOB S)
Packaging type	BOX
Country of origin	CN
GTIN	4050821145011
Customs tariff number	85369010000

Aprobări / certificate

Ex-Approvals



Emblemă	Aprobare	Text de aprobare suplimentar	Nume certificat
	AEx Underwriters Laboratories Inc.	UL 60079	20190704- E185892
	IECEX Physikalisch Technische Bundesanstalt	IEC 60079	IECEX PTB 03.0004U (Ex eb IIC Gb or Ex eb I Mb)

Supus modificărilor.



WAGO Kontakttechnik GmbH & Co. KG
/Representative Office Romania
Sos. Pipera-Tunari nr. 1/1
building 1, 2nd floor | 077190 Voluntari, Ilfov
Tel.: +40-(0)31 421 85 68 | Email: info-RO@wago.com

Aveți întrebări despre produsele noastre?
Vă stăm la dispoziție pentru preluarea apelului la +40 (0) 31 421 85 68.

Country specific Approvals

Emblemă	Aprobare	Text de aprobare suplimentar	Nume certificat
	CCA DEKRA Certification B.V.	EN 60947	NTR NL 7730
	CSA DEKRA Certification B.V.	C22.2 No. 158	1536069
	KEMA/KEUR DEKRA Certification B.V.	EN 60947	71- 107687

Ship Approvals

Emblemă	Aprobare	Text de aprobare suplimentar	Nume certificat
	ABS American Bureau of Shipping	EN 60947	20- HG1941090- PDA
	BV Bureau Veritas S.A.	EN 60947	38586/A0 BV
	DNV GL Det Norske Veritas, Germanischer Lloyd	-	TAE00001V2

UL-Approvals

Emblemă	Aprobare	Text de aprobare suplimentar	Nume certificat
	cURus Underwriters Laboratories Inc.	UL 1059	E45172

Counterpart











Supus modificărilor.

WAGO Kontakttechnik GmbH & Co. KG
/Representative Office Romania
Sos. Pipera-Tunari nr. 1/1
building 1, 2nd floor | 077190 Voluntari, Ilfov
Tel.: +40-(0)31 421 85 68 | Email: info-RO@wago.com

Aveți întrebări despre produsele noastre?
Vă stăm la dispoziție pentru preluarea apelului la +40 (0) 31 421 85 68.

Produse compatibile















Marking accessories

	Nr. articol: 2002-121 Adaptor	www.wago.com/2002-121
	Nr. articol: 2002-161 Adaptor	www.wago.com/2002-161
	Nr. articol: 2009-110 Marking strips; on reel; not stretchable; plain; snap-on type; white	www.wago.com/2009-110
	Nr. articol: 2009-115 WMB-Inline; for Smart Printer; 1500 pieces on roll; stretchable 5 - 5.2 mm; plain; snap-on type; white	www.wago.com/2009-115
	Nr. articol: 2009-115/000-002 WMB-Inline; for Smart Printer; 1500 pieces on roll; stretchable 5 - 5.2 mm; plain; snap-on type; yellow	www.wago.com/2009-115/000-002
	Nr. articol: 2009-115/000-005 WMB-Inline; for Smart Printer; 1500 pieces on roll; stretchable 5 - 5.2 mm; plain; snap-on type; red	www.wago.com/2009-115/000-005
	Nr. articol: 2009-115/000-006 WMB-Inline; for Smart Printer; 1500 pieces on roll; stretchable 5 - 5.2 mm; plain; snap-on type; blue	www.wago.com/2009-115/000-006
	Nr. articol: 2009-115/000-007 WMB-Inline; for Smart Printer; 1500 pieces on roll; stretchable 5 - 5.2 mm; plain; snap-on type; gray	www.wago.com/2009-115/000-007
	Nr. articol: 2009-115/000-012 WMB-Inline; for Smart Printer; 1500 pieces on roll; stretchable 5 - 5.2 mm; plain; snap-on type; orange	www.wago.com/2009-115/000-012
	Nr. articol: 2009-115/000-017 WMB-Inline; for Smart Printer; 1500 pieces on roll; stretchable 5 - 5.2 mm; plain; snap-on type; light green	www.wago.com/2009-115/000-017
	Nr. articol: 2009-115/000-023 WMB-Inline; for Smart Printer; 1500 pieces on roll; stretchable 5 - 5.2 mm; plain; snap-on type; green	www.wago.com/2009-115/000-023













Supus modificărilor.

WAGO Kontakttechnik GmbH & Co. KG
/Representative Office Romania
Sos. Pipera-Tunari nr. 1/1
building 1, 2nd floor | 077190 Voluntari, Ilfov
Tel.: +40-(0)31 421 85 68 | Email: info-RO@wago.com

Aveți întrebări despre produsele noastre?
Vă stăm la dispoziție pentru preluarea apelului la +40 (0) 31 421 85 68.

	Nr. articol: 2009-115/000-024 WMB-Inline; for Smart Printer; 1500 pieces on roll; stretchable 5 - 5.2 mm; plain; snap-on type; violet	www.wago.com/2009-115/000-024
	Nr. articol: 2009-145 Mini-WSB Inline; for Smart Printer; 1700 pieces on roll; stretchable 5 - 5.2 mm; plain; snap-on type; white	www.wago.com/2009-145
	Nr. articol: 2009-145/000-002 Mini-WSB Inline; for Smart Printer; 1700 pieces on roll; stretchable 5 - 5.2 mm; plain; snap-on type; yellow	www.wago.com/2009-145/000-002
	Nr. articol: 2009-145/000-005 Mini-WSB Inline; for Smart Printer; 1700 pieces on roll; stretchable 5 - 5.2 mm; plain; snap-on type; red	www.wago.com/2009-145/000-005
	Nr. articol: 2009-145/000-006 Mini-WSB Inline; for Smart Printer; 1700 pieces on roll; stretchable 5 - 5.2 mm; plain; snap-on type; blue	www.wago.com/2009-145/000-006
	Nr. articol: 2009-145/000-007 Mini-WSB Inline; for Smart Printer; 1700 pieces on roll; stretchable 5 - 5.2 mm; plain; snap-on type; gray	www.wago.com/2009-145/000-007
	Nr. articol: 2009-145/000-012 Mini-WSB Inline; for Smart Printer; 1700 pieces on roll; stretchable 5 - 5.2 mm; plain; snap-on type; orange	www.wago.com/2009-145/000-012
	Nr. articol: 2009-145/000-023 Mini-WSB Inline; for Smart Printer; 1700 pieces on roll; stretchable 5 - 5.2 mm; plain; snap-on type; green	www.wago.com/2009-145/000-023
	Nr. articol: 2009-145/000-024 Mini-WSB Inline; for Smart Printer; 1700 pieces on roll; stretchable 5 - 5.2 mm; plain; snap-on type; violet	www.wago.com/2009-145/000-024
	Nr. articol: 2009-191 Group marker carrier	www.wago.com/2009-191
	Nr. articol: 2009-192 Group marker carrier	www.wago.com/2009-192
	Nr. articol: 2009-193 Group marker carrier	www.wago.com/2009-193
	Nr. articol: 2009-198 Adaptor	www.wago.com/2009-198
	Nr. articol: 248-501 Miniature WSB Quick marking system; plain; Marker width 5 mm; 10 strips with 10 markers per card	www.wago.com/248-501
	Nr. articol: 248-501/000-002 Mini-WSB marking card; as card; not stretchable; plain; snap-on type; yellow	www.wago.com/248-501/000-002

Supus modificărilor.

	Nr. articol: 248-501/000-005 Mini-WSB marking card; as card; not stretchable; plain; snap-on type; red	www.wago.com/248-501/000-005
	Nr. articol: 248-501/000-006 Mini-WSB marking card; as card; not stretchable; plain; snap-on type; blue	www.wago.com/248-501/000-006
	Nr. articol: 248-501/000-007 Mini-WSB marking card; as card; not stretchable; plain; snap-on type; gray	www.wago.com/248-501/000-007
	Nr. articol: 248-501/000-012 Mini-WSB marking card; as card; not stretchable; plain; snap-on type; orange	www.wago.com/248-501/000-012
	Nr. articol: 248-501/000-017 Mini-WSB marking card; as card; not stretchable; plain; snap-on type; light green	www.wago.com/248-501/000-017
	Nr. articol: 248-501/000-023 Mini-WSB marking card; as card; not stretchable; plain; snap-on type; green	www.wago.com/248-501/000-023
	Nr. articol: 248-501/000-024 Mini-WSB marking card; as card; not stretchable; plain; snap-on type; violet	www.wago.com/248-501/000-024
	Nr. articol: 793-501 WMB marking card; as card; not stretchable; plain; snap-on type; white	www.wago.com/793-501
	Nr. articol: 793-501/000-002 WMB marking card; as card; not stretchable; plain; snap-on type; yellow	www.wago.com/793-501/000-002
	Nr. articol: 793-501/000-005 WMB marking card; as card; not stretchable; plain; snap-on type; red	www.wago.com/793-501/000-005
	Nr. articol: 793-501/000-006 WMB marking card; as card; not stretchable; plain; snap-on type; blue	www.wago.com/793-501/000-006
	Nr. articol: 793-501/000-007 WMB marking card; as card; not stretchable; plain; snap-on type; gray	www.wago.com/793-501/000-007
	Nr. articol: 793-501/000-012 WMB marking card; as card; not stretchable; plain; snap-on type; orange	www.wago.com/793-501/000-012

Supus modificărilor.

WAGO Kontakttechnik GmbH & Co. KG
/Representative Office Romania
Sos. Pipera-Tunari nr. 1/1
building 1, 2nd floor | 077190 Voluntari, Ilfov
Tel.: +40-(0)31 421 85 68 | Email: info-RO@wago.com

Aveți întrebări despre produsele noastre?
Vă stăm la dispoziție pentru preluarea apelului la +40 (0) 31 421 85 68.



Nr. articol: 793-501/000-017

WMB marking card; as card; not stretchable; plain; snap-on type; light green

www.wago.com/793-501/000-017



Nr. articol: 793-501/000-023

WMB marking card; as card; not stretchable; plain; snap-on type; green

www.wago.com/793-501/000-023



Nr. articol: 793-501/000-024

WMB marking card; as card; not stretchable; plain; snap-on type; violet

www.wago.com/793-501/000-024



Nr. articol: 793-5501

WMB marking card; as card; for terminal block width 5 - 17.5 mm; stretchable 5 - 5.2 mm; plain; snap-on type; white

www.wago.com/793-5501



Nr. articol: 793-5501/000-002

WMB marking card; as card; for terminal block width 5 - 17.5 mm; stretchable 5 - 5.2 mm; plain; snap-on type; yellow

www.wago.com/793-5501/000-002



Nr. articol: 793-5501/000-005

WMB marking card; as card; for terminal block width 5 - 17.5 mm; stretchable 5 - 5.2 mm; plain; snap-on type; red

www.wago.com/793-5501/000-005



Nr. articol: 793-5501/000-006

WMB marking card; as card; for terminal block width 5 - 17.5 mm; stretchable 5 - 5.2 mm; plain; snap-on type; blue

www.wago.com/793-5501/000-006



Nr. articol: 793-5501/000-007

WMB marking card; as card; for terminal block width 5 - 17.5 mm; stretchable 5 - 5.2 mm; plain; snap-on type; gray

www.wago.com/793-5501/000-007



Nr. articol: 793-5501/000-012

WMB marking card; as card; for terminal block width 5 - 17.5 mm; stretchable 5 - 5.2 mm; plain; snap-on type; orange

www.wago.com/793-5501/000-012



Nr. articol: 793-5501/000-014

WMB marking card; as card; for terminal block width 5 - 17.5 mm; stretchable 5 - 5.2 mm; plain; snap-on type; brown

www.wago.com/793-5501/000-014



Nr. articol: 793-5501/000-017

WMB marking card; as card; for terminal block width 5 - 17.5 mm; stretchable 5 - 5.2 mm; plain; snap-on type; green

www.wago.com/793-5501/000-017



Nr. articol: 793-5501/000-023

WMB marking card; as card; for terminal block width 5 - 17.5 mm; stretchable 5 - 5.2 mm; plain; snap-on type; light green

www.wago.com/793-5501/000-023



Nr. articol: 793-5501/000-024

WMB marking card; as card; for terminal block width 5 - 17.5 mm; stretchable 5 - 5.2 mm; plain; snap-on type; violet

www.wago.com/793-5501/000-024

End plate

Supus modificărilor.

WAGO Kontakttechnik GmbH & Co. KG
/Representative Office Romania
Sos. Pipera-Tunari nr. 1/1
building 1, 2nd floor | 077190 Voluntari, Ilfov
Tel.: +40-(0)31 421 85 68 | Email: info-RO@wago.com

Aveți întrebări despre produsele noastre?
Vă stăm la dispoziție pentru preluarea apelului la +40 (0) 31 421 85 68.



Nr. articol: 2002-2491
End and intermediate plate; 0.8 mm thick; gray

www.wago.com/2002-2491



Nr. articol: 2002-2492
End and intermediate plate; 0.8 mm thick; orange

www.wago.com/2002-2492

Protective Warning Marker



Nr. articol: 2002-115
Protective warning marker; with high-voltage symbol, black; for 5 terminal blocks; yellow

www.wago.com/2002-115

Jumper



Nr. articol: 2002-400
Adjacent jumper for continuous commoning; insulated; 2-way; Nominal current 25 A; light gray

www.wago.com/2002-400



Nr. articol: 2002-402
Push-in type jumper bar; insulated; 2-way; Nominal current 25 A; light gray

www.wago.com/2002-402



Nr. articol: 2002-402/000-005
Push-in type jumper bar; insulated; 2-way; Nominal current 25 A; red

www.wago.com/2002-402/000-005



Nr. articol: 2002-402/000-006
Push-in type jumper bar; insulated; 2-way; Nominal current 25 A; blue

www.wago.com/2002-402/000-006



Nr. articol: 2002-403
Push-in type jumper bar; insulated; 3-way; Nominal current 25 A; light gray

www.wago.com/2002-403



Nr. articol: 2002-403/000-005
Push-in type jumper bar; insulated; 3-way; Nominal current 25 A; red

www.wago.com/2002-403/000-005



Nr. articol: 2002-403/000-006
Push-in type jumper bar; insulated; 3-way; Nominal current 25 A; blue

www.wago.com/2002-403/000-006



Nr. articol: 2002-404
Push-in type jumper bar; insulated; 4-way; Nominal current 25 A; light gray

www.wago.com/2002-404



Nr. articol: 2002-404/000-005
Push-in type jumper bar; insulated; 4-way; Nominal current 25 A; red

www.wago.com/2002-404/000-005



Nr. articol: 2002-404/000-006
Push-in type jumper bar; insulated; 4-way; Nominal current 25 A; blue

www.wago.com/2002-404/000-006



Nr. articol: 2002-405
Push-in type jumper bar; insulated; 5-way; Nominal current 25 A; light gray















www.wago.com/2002-405



















Nr. articol: 2002-405/000-005
Push-in type jumper bar; insulated; 5-way; Nominal current 25 A; red

www.wago.com/2002-405/000-005











Supus modificărilor.

	Nr. articol: 2002-405/000-006 Push-in type jumper bar; insulated; 5-way; Nominal current 25 A; blue	www.wago.com/2002-405/000-006
	Nr. articol: 2002-405/011-000 Star point jumper; insulated; 3-way (1-3-5); IN = IN terminal block; light gray	www.wago.com/2002-405/011-000
	Nr. articol: 2002-406 Push-in type jumper bar; insulated; 6-way; Nominal current 25 A; light gray	www.wago.com/2002-406
	Nr. articol: 2002-406/000-005 Push-in type jumper bar; insulated; 6-way; Nominal current 25 A; red	www.wago.com/2002-406/000-005
	Nr. articol: 2002-406/000-006 Push-in type jumper bar; insulated; 6-way; Nominal current 25 A; blue	www.wago.com/2002-406/000-006
	Nr. articol: 2002-406/020-000 Delta jumper; insulated; 1-2 3-4 5-6; IN = IN terminal block; light gray	www.wago.com/2002-406/020-000
	Nr. articol: 2002-407 Push-in type jumper bar; insulated; 7-way; Nominal current 25 A; light gray	www.wago.com/2002-407
	Nr. articol: 2002-407/000-005 Push-in type jumper bar; insulated; 7-way; Nominal current 25 A; red	www.wago.com/2002-407/000-005
	Nr. articol: 2002-407/000-006 Push-in type jumper bar; insulated; 7-way; Nominal current 25 A; blue	www.wago.com/2002-407/000-006
	Nr. articol: 2002-408 Push-in type jumper bar; insulated; 8-way; Nominal current 25 A; light gray	www.wago.com/2002-408
	Nr. articol: 2002-408/000-005 Push-in type jumper bar; insulated; 8-way; Nominal current 25 A; red	www.wago.com/2002-408/000-005
	Nr. articol: 2002-408/000-006 Push-in type jumper bar; insulated; 8-way; Nominal current 25 A; blue	www.wago.com/2002-408/000-006
	Nr. articol: 2002-409 Push-in type jumper bar; insulated; 9-way; Nominal current 25 A; light gray	www.wago.com/2002-409
	Nr. articol: 2002-409/000-005 Push-in type jumper bar; insulated; 9-way; Nominal current 25 A; red	www.wago.com/2002-409/000-005

Supus modificărilor.

	Nr. articol: 2002-409/000-006 Push-in type jumper bar; insulated; 9-way; Nominal current 25 A; blue	www.wago.com/2002-409/000-006
	Nr. articol: 2002-410 Push-in type jumper bar; insulated; 10-way; Nominal current 25 A; light gray	www.wago.com/2002-410
	Nr. articol: 2002-410/000-005 Push-in type jumper bar; insulated; 10-way; Nominal current 25 A; red	www.wago.com/2002-410/000-005
	Nr. articol: 2002-410/000-006 Push-in type jumper bar; insulated; 10-way; Nominal current 25 A; blue	www.wago.com/2002-410/000-006
	Nr. articol: 2002-423 Adjacent jumper for continuous commoning; insulated; from 1 to 3; Nominal current 25 A; light gray	www.wago.com/2002-423
	Nr. articol: 2002-423/000-005 Adjacent jumper for continuous commoning; insulated; from 1 to 3; Nominal current 25 A; red	www.wago.com/2002-423/000-005
	Nr. articol: 2002-423/000-006 Adjacent jumper for continuous commoning; insulated; from 1 to 3; Nominal current 25 A; blue	www.wago.com/2002-423/000-006
	Nr. articol: 2002-433 Push-in type jumper bar; insulated; from 1 to 3; Nominal current 25 A; light gray	www.wago.com/2002-433
	Nr. articol: 2002-434 Push-in type jumper bar; insulated; from 1 to 4; Nominal current 25 A; light gray	www.wago.com/2002-434
	Nr. articol: 2002-435 Push-in type jumper bar; insulated; from 1 to 5; Nominal current 25 A; light gray	www.wago.com/2002-435
	Nr. articol: 2002-436 Push-in type jumper bar; insulated; from 1 to 6; Nominal current 25 A; light gray	www.wago.com/2002-436
	Nr. articol: 2002-437 Push-in type jumper bar; insulated; from 1 to 7; Nominal current 25 A; light gray	www.wago.com/2002-437
	Nr. articol: 2002-438 Push-in type jumper bar; insulated; from 1 to 8; Nominal current 25 A; light gray	www.wago.com/2002-438
	Nr. articol: 2002-439 Push-in type jumper bar; insulated; from 1 to 9; Nominal current 25 A; light gray	www.wago.com/2002-439
	Nr. articol: 2002-440 Push-in type jumper bar; insulated; from 1 to 10; Nominal current 25 A; light gray	www.wago.com/2002-440
	Nr. articol: 2002-472 Staggered jumper; insulated; 2-way; Nominal current 25 A; suitable for 2002 and 2003 Series rail-mounted terminal blocks; light gray	www.wago.com/2002-472













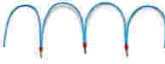

Supus modificărilor.

	Nr. articol: 2002-473 Staggered jumper; insulated; 3-way; Nominal current 25 A; suitable for 2002 and 2003 Series rail-mounted terminal blocks; light gray	www.wago.com/2002-473
	Nr. articol: 2002-473/011-000 Ready-made staggered jumper; insulated; 2-way (1-3); Nominal current 25 A; with contact lugs broken off at the factory and circuit marking; light gray	www.wago.com/2002-473/011-000
	Nr. articol: 2002-474 Staggered jumper; insulated; 4-way; Nominal current 25 A; suitable for 2002 and 2003 Series rail-mounted terminal blocks; light gray	www.wago.com/2002-474
	Nr. articol: 2002-475 Staggered jumper; insulated; 5-way; Nominal current 25 A; suitable for 2002 and 2003 Series rail-mounted terminal blocks; light gray	www.wago.com/2002-475
	Nr. articol: 2002-475/011-000 Ready-made staggered jumper; insulated; 3-way (1-3-5); Nominal current 25 A; with contact lugs broken off at the factory and circuit marking; light gray	www.wago.com/2002-475/011-000
	Nr. articol: 2002-476 Staggered jumper; insulated; 6-way; Nominal current 25 A; suitable for 2002 and 2003 Series rail-mounted terminal blocks; light gray	www.wago.com/2002-476
	Nr. articol: 2002-477 Staggered jumper; insulated; 7-way; Nominal current 25 A; suitable for 2002 and 2003 Series rail-mounted terminal blocks; light gray	www.wago.com/2002-477
	Nr. articol: 2002-477/011-000 Ready-made staggered jumper; insulated; 1-3-5-7; Nominal current 25 A; with contact lugs broken off at the factory and circuit marking; light gray	www.wago.com/2002-477/011-000
	Nr. articol: 2002-478 Staggered jumper; insulated; 8-way; Nominal current 25 A; suitable for 2002 and 2003 Series rail-mounted terminal blocks; light gray	www.wago.com/2002-478
	Nr. articol: 2002-479 Staggered jumper; insulated; 9-way; Nominal current 25 A; suitable for 2002 and 2003 Series rail-mounted terminal blocks; light gray	www.wago.com/2002-479
	Nr. articol: 2002-479/011-000 Ready-made staggered jumper; insulated; 1-3-5-7-9; Nominal current 25 A; with contact lugs broken off at the factory and circuit marking; light gray	www.wago.com/2002-479/011-000
	Nr. articol: 2002-480 Staggered jumper; insulated; 10-way; Nominal current 25 A; suitable for 2002 and 2003 Series rail-mounted terminal blocks; light gray	www.wago.com/2002-480
	Nr. articol: 2002-481 Staggered jumper; insulated; 11-way; Nominal current 25 A; suitable for 2002 and 2003 Series rail-mounted terminal blocks; light gray	www.wago.com/2002-481
	Nr. articol: 2002-481/011-000 Ready-made staggered jumper; insulated; 1-3-5-7-9-11; Nominal current 25 A; with contact lugs broken off at the factory and circuit marking; light gray	www.wago.com/2002-481/011-000
	Nr. articol: 2002-482 Staggered jumper; insulated; 12-way; Nominal current 25 A; suitable for 2002 and 2003 Series rail-mounted terminal blocks; light gray	www.wago.com/2002-482















Supus modificărilor.

WAGO Kontakttechnik GmbH & Co. KG
/Representative Office Romania
Sos. Pipera-Tunari nr. 1/1
building 1, 2nd floor | 077190 Voluntari, Ilfov
Tel.: +40-(0)31 421 85 68 | Email: info-RO@wago.com









Aveți întrebări despre produsele noastre?
Vă stăm la dispoziție pentru preluarea apelului la +40 (0) 31 421 85 68.

	Nr. articol: 2002-492 Double-deck vertical jumper; insulated; light gray	www.wago.com/2002-492
	Nr. articol: 2002-492/000-012 Double-deck vertical jumper; insulated; orange	www.wago.com/2002-492/000-012
	Nr. articol: 210-103 Wire commoning chain; insulated; 50 connections; black	www.wago.com/210-103
	Nr. articol: 210-123 Wire commoning chain; insulated; 50 connections	www.wago.com/210-123
ferrule		
	Nr. articol: 216-241 Ferrule; Sleeve for 0.5 mm ² / 20 AWG; insulated; electro-tin plated; electrolytic copper; gastight crimped; acc. to DIN 46228, Part 4/09.90; white	www.wago.com/216-241
	Nr. articol: 216-242 Ferrule; Sleeve for 0.75 mm ² / 18 AWG; insulated; electro-tin plated; electrolytic copper; gastight crimped; acc. to DIN 46228, Part 4/09.90; gray	www.wago.com/216-242
	Nr. articol: 216-243 Ferrule; Sleeve for 1 mm ² / AWG 18; insulated; electro-tin plated; electrolytic copper; gastight crimped; acc. to DIN 46228, Part 4/09.90; red	www.wago.com/216-243
	Nr. articol: 216-244 Ferrule; Sleeve for 1.5 mm ² / AWG 16; insulated; electro-tin plated; electrolytic copper; gastight crimped; acc. to DIN 46228, Part 4/09.90; black	www.wago.com/216-244
	Nr. articol: 216-246 Ferrule; Sleeve for 2.5 mm ² / AWG 14; insulated; electro-tin plated; electrolytic copper; gastight crimped; acc. to DIN 46228, Part 4/09.90; blue	www.wago.com/216-246
	Nr. articol: 216-262 Ferrule; Sleeve for 0.75 mm ² / 18 AWG; insulated; electro-tin plated; electrolytic copper; gastight crimped; acc. to DIN 46228, Part 4/09.90; gray	www.wago.com/216-262
	Nr. articol: 216-263 Ferrule; Sleeve for 1 mm ² / AWG 18; insulated; electro-tin plated; electrolytic copper; gastight crimped; acc. to DIN 46228, Part 4/09.90; red	www.wago.com/216-263
	Nr. articol: 216-264 Ferrule; Sleeve for 1.5 mm ² / AWG 16; insulated; electro-tin plated; electrolytic copper; gastight crimped; acc. to DIN 46228, Part 4/09.90; black	www.wago.com/216-264
	Nr. articol: 216-266 Ferrule; Sleeve for 2.5 mm ² / AWG 14; insulated; electro-tin plated; electrolytic copper; gastight crimped; acc. to DIN 46228, Part 4/09.90; blue	www.wago.com/216-266
Push-In type wire jumper		
	Nr. articol: 2009-412 Push-in type wire jumper; insulated; wire length 60 mm; Conductor cross section 1.5 mm ² ; suitable for 2001, 2002, 2003 and 2022 Series rail-mounted terminal blocks; black	www.wago.com/2009-412
	Nr. articol: 2009-414 Push-in type wire jumper; insulated; wire length 110 mm; Conductor cross section 1.5 mm ² ; suitable for 2001, 2002, 2003 and 2022 Series rail-mounted terminal blocks; black	www.wago.com/2009-414

Supus modificărilor.

	Nr. articol: 2009-414/000-005 Push-in type wire jumper; insulated; wire length 110 mm; Conductor cross section 1.5 mm ² ; suitable for 2001, 2002, 2003 and 2022 Series rail-mounted terminal blocks; red	www.wago.com/2009-414/000-005
	Nr. articol: 2009-414/000-006 Push-in type wire jumper; insulated; wire length 110 mm; Conductor cross section 1.5 mm ² ; suitable for 2001, 2002, 2003 and 2022 Series rail-mounted terminal blocks; blue	www.wago.com/2009-414/000-006
	Nr. articol: 2009-416 Push-in type wire jumper; insulated; wire length 250 mm; Conductor cross section 1.5 mm ² ; suitable for 2001, 2002, 2003 and 2022 Series rail-mounted terminal blocks; black	www.wago.com/2009-416
tools		
	Nr. articol: 210-658 Operating tool; Blade: 3.5 x 0.5 mm; with a partially insulated shaft; angled; short	www.wago.com/210-658
	Nr. articol: 210-720 Operating tool; Blade: 3.5 x 0.5 mm; with a partially insulated shaft	www.wago.com/210-720
check		
	Nr. articol: 2002-611 TOPJOB®S L-type test plug module; modular; 1-pole; 2,50 mm ² ; gray	www.wago.com/2002-611
	Nr. articol: 2002-649 TOPJOB®S L-type spacer module; modular; e.g., for bridging commoned terminal blocks; gray	www.wago.com/2002-649
	Nr. articol: 2009-174 Test plug adapter; for 4 mm Ø test plugs; for testing TOPJOB®S rail-mounted terminal blocks; gray	www.wago.com/2009-174
	Nr. articol: 2009-182 Testing tap; for max. 2.5 mm ² ; tool-free connection for individual test wires 0.08 - 2.5 mm; gray	www.wago.com/2009-182
Insulation stop		
	Nr. articol: 2002-171 Insulation stop; 0.25 - 0.5 mm ² ; 5 pieces/strip; light gray	www.wago.com/2002-171
	Nr. articol: 2002-172 Insulation stop; 0.75 - 1 mm ² ; 5 pieces/strip; dark gray	www.wago.com/2002-172
Carrier rail		
	Nr. articol: 210-112 Steel carrier rail; 35 x 7.5 mm; 1 mm thick; 2 m long; slotted; according to EN 60715; "Hole width 25 mm	www.wago.com/210-112
	Nr. articol: 210-113 Steel carrier rail; 35 x 7.5 mm; 1 mm thick; 2 m long; unslotted; according to EN 60715	www.wago.com/210-113
	Nr. articol: 210-114 Steel carrier rail; 35 x 15 mm; 1.5 mm thick; 2 m long; unslotted; similar to EN 60715	www.wago.com/210-114
	Nr. articol: 210-115 Steel carrier rail; 35 x 7.5 mm; 1 mm thick; 2 m long; slotted; according to EN 60715; "Hole width 18 mm	www.wago.com/210-115
	Nr. articol: 210-118	

Supus modificărilor.

	Steel carrier rail; 35 x 15 mm; 2.3 mm thick; 2 m long; unslotted; according to EN 60715	www.wago.com/210-118
	Nr. articol: 210-196 Aluminum carrier rail; 35 x 8.2 mm; 1.6 mm thick; 2 m long; unslotted; similar to EN 60715; silver-colored	www.wago.com/210-196
	Nr. articol: 210-197 Steel carrier rail; 35 x 15 mm; 1.5 mm thick; 2 m long; slotted; similar to EN 60715	www.wago.com/210-197
	Nr. articol: 210-198 Copper carrier rail; 35 x 15 mm; 2.3 mm thick; 2 m long; unslotted; according to EN 60715; copper-colored	www.wago.com/210-198
	Nr. articol: 210-504 Steel carrier rail; 35 x 7.5 mm; 1 mm thick; 2 m long; slotted; galvanized; according to EN 60715	www.wago.com/210-504
	Nr. articol: 210-505 Steel carrier rail; 35 x 7.5 mm; 1 mm thick; 2 m long; unslotted; galvanized; according to EN 60715	www.wago.com/210-505
	Nr. articol: 210-506 Steel carrier rail; 35 x 15 mm; 1.5 mm thick; 2 m long; unslotted; galvanized; similar to EN 60715	www.wago.com/210-506
	Nr. articol: 210-508 Steel carrier rail; 35 x 15 mm; 1.5 mm thick; 2 m long; slotted; galvanized; similar to EN 60715	www.wago.com/210-508

Descărcări

Documentation

Additional Information

Technical explanations	Apr 3, 2019	pdf 2,1 MB	Descărcare
------------------------	-------------	---------------	------------

CAD/CAE-Data

CAD data

2D/3D Models 2002-2408	URL	Descărcare
------------------------	-----	------------

CAE data

EPLAN Data Portal 2002-2408	URL	Descărcare
-----------------------------	-----	------------

WSCAD Universe 2002-2408	URL	Descărcare
--------------------------	-----	------------

Installation Notes

Conductor termination

Supus modificărilor.

WAGO Kontakttechnik GmbH & Co. KG
/Representative Office Romania
Sos. Pipera-Tunari nr. 1/1
building 1, 2nd floor | 077190 Voluntari, Ilfov
Tel.: +40-(0)31 421 85 68 | Email: info-RO@wago.com

Aveți întrebări despre produsele noastre?
Vă stăm la dispoziție pentru preluarea apelului la +40 (0) 31 421 85 68.



All conductor types at a glance



Terminating solid and ferruled conductors via push-in connection.



Inserting conductors via push-in termination.

Solid conductors with cross-sections from either one size above, or up to two sizes below, the rated cross-section can be simply pushed in – no tools needed.

Supus modificărilor.

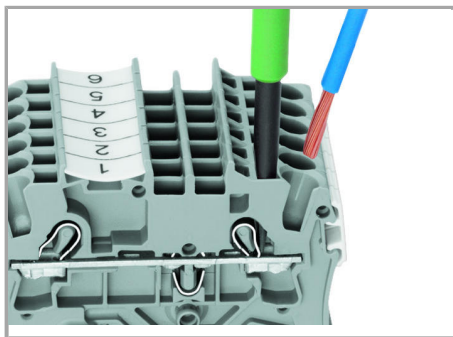

Inserting a conductor via operating tool.

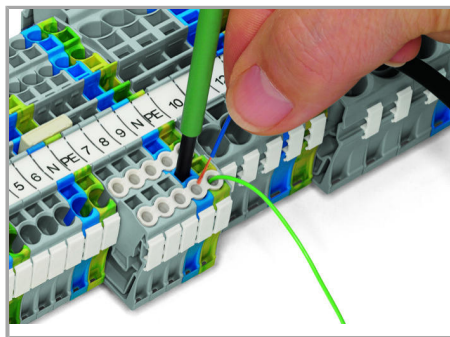

Conductor termination – Insulation stop.

Connecting fine-stranded conductors without ferrules, or small cross-sectional conductors that cannot be pushed in, is performed similarly to the original CAGE CLAMP® – just use an operating tool.

The smart feature:

To open the clamp, the operating tool is inserted vertically. The conductor entry is less than 15 degrees for easier wiring.

Familie de produse

TOPJOB® S

TOPJOB® S: In various industrial applications and modern building installations, WAGO's wide and versatile range of rail-mount terminal blocks provides more than just reliable electrical connections.

[Afișare globală produse din familie.](#)

Supus modificărilor.