

Fișă tehnică | Număr articol: 2022-1201

1-conductor/1-pin carrier terminal block; for DIN-rail 35 x 15 and 35 x 7.5;
2.5 mm²; Push-in CAGE CLAMP®; 2,50 mm²; gray

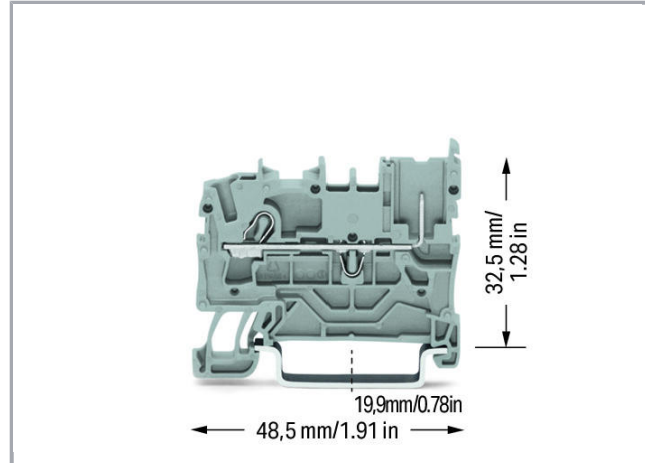

www.wago.com/2022-1201

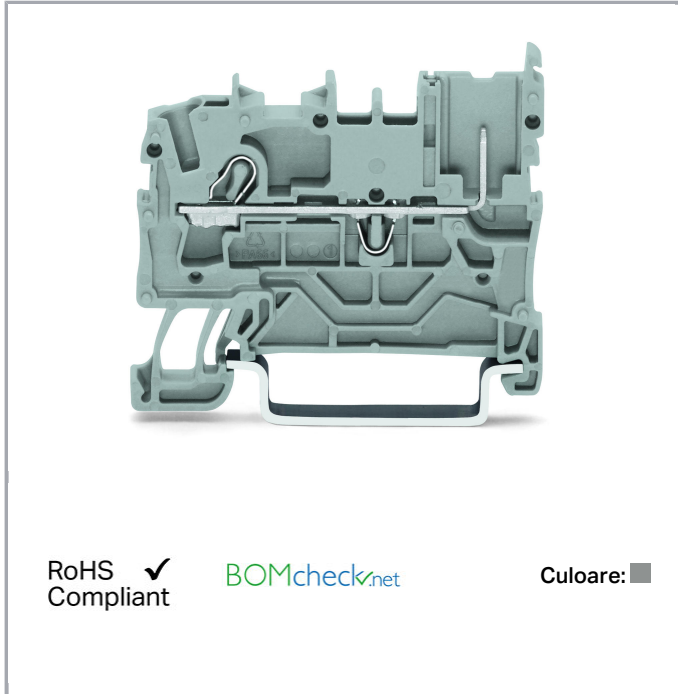

RoHS
Compliant

[BOMcheck.net](https://www.bomcheck.net)

Culoare: ■

Date

Electrical data

Ratings per IEC/EN 60664-1

| Ratings per | IEC/EN 60947-7-1 |
|-----------------------------|---|
| Nominal voltage (III/3) | 690 V |
| Rated surge voltage (III/3) | 6 kV |
| Rated current | 24 A |
| Rated current 2 | 32 A |
| Legend (ratings) | (III / 3) ≙ Overvoltage category III / Pollution degree 3 |

Connection data

| | |
|-----------------------|---------------------------|
| Connection technology | Push-in CAGE CLAMP® |
| Actuation type | Open Tool Slot Push-in |

Supus modificărilor.

WAGO Kontakttechnik GmbH & Co. KG
/Representative Office Romania
Sos. Pipera-Tunari nr. 1/1
building 1, 2nd floor | 077190 Voluntari, Ilfov
Tel.: +40-(0)31 421 85 68 | Email: info-RO@wago.com

Aveți întrebări despre produsele noastre?
Vă stăm la dispoziție pentru preluarea apelului la +40 (0) 31 421 85 68.



| | |
|--|---|
| Connectable conductor materials | Copper |
| Nominal cross-section | 2.5 mm ² |
| Solid conductor | 0.25 ... 4 mm ² / 22 ... 12 AWG |
| Solid conductor; push-in termination | 0.75 ... 4 mm ² / 18 ... 12 AWG |
| Fine-stranded conductor | 0.25 ... 4 mm ² / 22 ... 12 AWG |
| Fine-stranded conductor; with insulated ferrule | 1 ... 2.5 mm ² / 18 ... 12 AWG |
| Fine-stranded conductor; with ferrule; push-in termination | 1 ... 2.5 mm ² / 18 ... 12 AWG |
| Strip length | 10 ... 12 mm / 0.39 ... 0.47 inch |
| Total number of connection points | 1 |
| Total number of potentials | 1 |
| Number of levels | 1 |
| Wiring type | Front-entry wiring |
| Note (conductor cross-section) | Depending on the conductor characteristic, a conductor with a smaller cross section can also be inserted via push-in termination. |

Geometrical Data

| | |
|------------------------------------|----------------------|
| Width | 5.2 mm / 0.205 inch |
| Height from upper-edge of DIN-rail | 32.5 mm / 1.28 inch |
| Depth | 48.5 mm / 1.909 inch |

Mechanical data

| | |
|---------------|---------------------|
| Design | horizontal |
| Mounting type | DIN-35 rail |
| Marking level | Center/side marking |

Material Data

| | |
|---------------------|----------------------|
| Color | gray |
| Insulation material | Polyamide 66 (PA 66) |
| Fire load | 0,112 MJ |
| Weight | 5 g |

Commercial data

| | |
|-----------------------|-------------------|
| Product Group | 18 (X-COM-System) |
| Packaging type | BOX |
| Country of origin | CN |
| GTIN | 4050821145059 |
| Customs tariff number | 85366990990 |



Supus modificărilor.

WAGO Kontakttechnik GmbH & Co. KG
 /Representative Office Romania
 Sos. Pipera-Tunari nr. 1/1
 building 1, 2nd floor | 077190 Voluntari, Ilfov
 Tel.: +40-(0)31 421 85 68 | Email: info-RO@wago.com

Aveți întrebări despre produsele noastre?
 Vă stăm la dispoziție pentru preluarea apelului la +40 (0) 31 421 85 68.

Aprobări / certificate

Country specific Approvals

| Emblemă | Aprobare | Text de aprobare suplimentar | Nume certificat |
|--|---------------------------------|------------------------------|-----------------|
|  | CCA DEKRA Certification B.V. | EN 60947 | NTR NL 7628 |
|  | CSA DEKRA Certification B.V. | C22.2 No. 158 | 2437422 |

UL-Approvals

| Emblemă | Aprobare | Text de aprobare suplimentar | Nume certificat |
|--|--------------------------------------|------------------------------|-----------------|
|  | UR Underwriters Laboratories Inc. | UL 1059 | E45172 |

Counterpart

Produse compatibile





Female plug

**Nr. articol: 2022-101**1-conductor female plug; 2.5 mm²; 1-pole; 2,50 mm²; graywww.wago.com/2022-101











Supus modificărilor.

WAGO Kontakttechnik GmbH & Co. KG
/Representative Office Romania
Sos. Pipera-Tunari nr. 1/1
building 1, 2nd floor | 077190 Voluntari, Ilfov
Tel.: +40-(0)31 421 85 68 | Email: info-RO@wago.com

Aveți întrebări despre produsele noastre?
Vă stăm la dispoziție pentru preluarea apelului la +40 (0) 31 421 85 68.

| | | |
|---|---|--|
|  | Nr. articol: 2022-101/000-006 1-conductor female plug; 1-pole; 2,50 mm ² ; blue | www.wago.com/2022-101/000-006 |
|  | Nr. articol: 2022-101/000-012 1-conductor female plug; 1-pole; 2,50 mm ² ; orange | www.wago.com/2022-101/000-012 |
|  | Nr. articol: 2022-101/000-016 1-conductor female plug; 1-pole; 2,50 mm ² ; green-yellow | www.wago.com/2022-101/000-016 |
| | Nr. articol: 2022-101/122-000 1-conductor female plug; 1-pole; 2,50 mm ² ; gray | www.wago.com/2022-101/122-000 |
| | Nr. articol: 2022-101/122-006 1-conductor female plug; 1-pole; 2,50 mm ² ; blue | www.wago.com/2022-101/122-006 |
| | Nr. articol: 2022-101/122-016 1-conductor female plug; 1-pole; 2,50 mm ² ; green-yellow | www.wago.com/2022-101/122-016 |
| | Nr. articol: 2022-101/132-000 1-conductor female plug; Strain relief plate; 1-pole; 2,50 mm ² ; gray | www.wago.com/2022-101/132-000 |
| | Nr. articol: 2022-101/132-006 1-conductor female plug; Strain relief plate; 1-pole; 2,50 mm ² ; blue | www.wago.com/2022-101/132-006 |
| | Nr. articol: 2022-101/132-016 1-conductor female plug; Strain relief plate; 1-pole; 2,50 mm ² ; green-yellow | www.wago.com/2022-101/132-016 |
| | Nr. articol: 2022-101/142-000 1-conductor female plug; Strain relief plate; 1-pole; 2,50 mm ² ; gray | www.wago.com/2022-101/142-000 |
| | Nr. articol: 2022-101/142-006 1-conductor female plug; Strain relief plate; 1-pole; 2,50 mm ² ; blue | www.wago.com/2022-101/142-006 |
| | Nr. articol: 2022-101/142-016 1-conductor female plug; Strain relief plate; 1-pole; 2,50 mm ² ; green-yellow | www.wago.com/2022-101/142-016 |
|  | Nr. articol: 2022-102 1-conductor female plug; 2.5 mm ² ; 2-pole; 2,50 mm ² ; gray | www.wago.com/2022-102 |
|  | Nr. articol: 2022-102/000-006 1-conductor female plug; 2.5 mm ² ; 2-pole; 2,50 mm ² ; blue | www.wago.com/2022-102/000-006 |

Supus modificărilor.

| | | |
|--|---|--|
|  | Nr. articol: 2022-102/000-012 1-conductor female plug; 2.5 mm ² ; 2-pole; 2,50 mm ² ; orange | www.wago.com/2022-102/000-012 |
|  | Nr. articol: 2022-102/000-016 1-conductor female plug; 2.5 mm ² ; 2-pole; 2,50 mm ² ; green-yellow | www.wago.com/2022-102/000-016 |
|  | Nr. articol: 2022-102/000-038 1-conductor female plug; 2.5 mm ² ; 2-pole; 2,50 mm ² ; blue/gray | www.wago.com/2022-102/000-038 |
|  | Nr. articol: 2022-102/000-039 1-conductor female plug; 2.5 mm ² ; 2-pole; 2,50 mm ² ; green-yellow/blue/gray | www.wago.com/2022-102/000-039 |
| | Nr. articol: 2022-102/122-000 1-conductor female plug; Locking lever; 2.5 mm ² ; 2-pole; 2,50 mm ² ; gray | www.wago.com/2022-102/122-000 |
| | Nr. articol: 2022-102/132-000 1-conductor female plug; Strain relief plate; 2.5 mm ² ; 2-pole; 2,50 mm ² ; gray | www.wago.com/2022-102/132-000 |
| | Nr. articol: 2022-102/142-000 1-conductor female plug; Strain relief plate; 2.5 mm ² ; 2-pole; 2,50 mm ² ; gray | www.wago.com/2022-102/142-000 |
|  | Nr. articol: 2022-103 1-conductor female plug; 2.5 mm ² ; 3-pole; 2,50 mm ² ; gray | www.wago.com/2022-103 |
|  | Nr. articol: 2022-103/000-006 1-conductor female plug; 2.5 mm ² ; 3-pole; 2,50 mm ² ; blue | www.wago.com/2022-103/000-006 |
|  | Nr. articol: 2022-103/000-012 1-conductor female plug; 2.5 mm ² ; 3-pole; 2,50 mm ² ; orange | www.wago.com/2022-103/000-012 |
|  | Nr. articol: 2022-103/000-016 1-conductor female plug; 2.5 mm ² ; 3-pole; 2,50 mm ² ; green-yellow | www.wago.com/2022-103/000-016 |
|  | Nr. articol: 2022-103/000-036 1-conductor female plug; 2.5 mm ² ; 3-pole; 2,50 mm ² ; gray, green-yellow | www.wago.com/2022-103/000-036 |
|  | Nr. articol: 2022-103/000-037 1-conductor female plug; 2.5 mm ² ; 3-pole; 2,50 mm ² ; green-yellow, gray | www.wago.com/2022-103/000-037 |

Supus modificărilor.



Nr. articol: 2022-103/000-038

1-conductor female plug; 2.5 mm²; 3-pole; 2,50 mm²; gray, blue, green-yellow

www.wago.com/2022-103/000-038



Nr. articol: 2022-103/000-039

1-conductor female plug; 2.5 mm²; 3-pole; 2,50 mm²; green-yellow, blue, gray

www.wago.com/2022-103/000-039

Nr. articol: 2022-103/123-000

1-conductor female plug; Locking lever; 2.5 mm²; 3-pole; 2,50 mm²; gray

www.wago.com/2022-103/123-000

Nr. articol: 2022-103/133-000

1-conductor female plug; Strain relief plate; 2.5 mm²; 3-pole; 2,50 mm²; gray

www.wago.com/2022-103/133-000

Nr. articol: 2022-103/143-000

1-conductor female plug; Strain relief plate; 2.5 mm²; 3-pole; 2,50 mm²; gray

www.wago.com/2022-103/143-000



Nr. articol: 2022-104

1-conductor female plug; 2.5 mm²; 4-pole; 2,50 mm²; gray

www.wago.com/2022-104



Nr. articol: 2022-104/000-006

1-conductor female plug; 2.5 mm²; 4-pole; 2,50 mm²; blue

www.wago.com/2022-104/000-006



Nr. articol: 2022-104/000-012

1-conductor female plug; 2.5 mm²; 4-pole; 2,50 mm²; orange

www.wago.com/2022-104/000-012



Nr. articol: 2022-104/000-016

1-conductor female plug; 2.5 mm²; 4-pole; 2,50 mm²; green-yellow

www.wago.com/2022-104/000-016



Nr. articol: 2022-104/000-036

1-conductor female plug; 2.5 mm²; 4-pole; 2,50 mm²; gray, green-yellow

www.wago.com/2022-104/000-036



Nr. articol: 2022-104/000-037

1-conductor female plug; 2.5 mm²; 4-pole; 2,50 mm²; green-yellow, gray

www.wago.com/2022-104/000-037



Nr. articol: 2022-104/000-038

1-conductor female plug; 2.5 mm²; 4-pole; 2,50 mm²; gray, blue, green-yellow

www.wago.com/2022-104/000-038













Nr. articol: 2022-104/000-039











1-conductor female plug; 2.5 mm²; 4-pole; 2,50 mm²; green-yellow, blue, gray

www.wago.com/2022-104/000-039

Supus modificărilor.

| | | |
|--|---|--|
| | Nr. articol: 2022-104/123-000 1-conductor female plug; Locking lever; 2.5 mm ² ; 4-pole; 2,50 mm ² ; gray | www.wago.com/2022-104/123-000 |
| | Nr. articol: 2022-104/133-000 1-conductor female plug; Strain relief plate; 2.5 mm ² ; 4-pole; 2,50 mm ² ; gray | www.wago.com/2022-104/133-000 |
| | Nr. articol: 2022-104/143-000 1-conductor female plug; Strain relief plate; 2.5 mm ² ; 4-pole; 2,50 mm ² ; gray | www.wago.com/2022-104/143-000 |
|  | Nr. articol: 2022-105 1-conductor female plug; 2.5 mm ² ; 5-pole; 2,50 mm ² ; gray | www.wago.com/2022-105 |
|  | Nr. articol: 2022-105/000-006 1-conductor female plug; 2.5 mm ² ; 5-pole; 2,50 mm ² ; blue | www.wago.com/2022-105/000-006 |
|  | Nr. articol: 2022-105/000-012 1-conductor female plug; 2.5 mm ² ; 5-pole; 2,50 mm ² ; orange | www.wago.com/2022-105/000-012 |
|  | Nr. articol: 2022-105/000-016 1-conductor female plug; 2.5 mm ² ; 5-pole; 2,50 mm ² ; green-yellow | www.wago.com/2022-105/000-016 |
|  | Nr. articol: 2022-105/000-036 1-conductor female plug; 2.5 mm ² ; 5-pole; 2,50 mm ² ; gray, green-yellow | www.wago.com/2022-105/000-036 |
|  | Nr. articol: 2022-105/000-037 1-conductor female plug; 2.5 mm ² ; 5-pole; 2,50 mm ² ; green-yellow, gray | www.wago.com/2022-105/000-037 |
|  | Nr. articol: 2022-105/000-038 1-conductor female plug; 2.5 mm ² ; 5-pole; 2,50 mm ² ; gray, blue, green-yellow | www.wago.com/2022-105/000-038 |
|  | Nr. articol: 2022-105/000-039 1-conductor female plug; 2.5 mm ² ; 5-pole; 2,50 mm ² ; green-yellow, blue, gray | www.wago.com/2022-105/000-039 |
|  | Nr. articol: 2022-105/123-000 1-conductor female plug; Locking lever; 2.5 mm ² ; 5-pole; 2,50 mm ² ; gray | www.wago.com/2022-105/123-000 |
|  | Nr. articol: 2022-105/134-000 1-conductor female plug; Strain relief plate; 2.5 mm ² ; 5-pole; 2,50 mm ² ; gray | www.wago.com/2022-105/134-000 |

Supus modificărilor.

| | | |
|--|---|--|
|  | Nr. articol: 2022-105/144-000 1-conductor female plug; Strain relief plate; 2.5 mm ² ; 5-pole; 2,50 mm ² ; gray | www.wago.com/2022-105/144-000 |
|  | Nr. articol: 2022-106 1-conductor female plug; 2.5 mm ² ; 6-pole; 2,50 mm ² ; gray | www.wago.com/2022-106 |
|  | Nr. articol: 2022-106/000-006 1-conductor female plug; 2.5 mm ² ; 6-pole; 2,50 mm ² ; blue | www.wago.com/2022-106/000-006 |
|  | Nr. articol: 2022-106/000-012 1-conductor female plug; 2.5 mm ² ; 6-pole; 2,50 mm ² ; orange | www.wago.com/2022-106/000-012 |
|  | Nr. articol: 2022-106/000-016 1-conductor female plug; 2.5 mm ² ; 6-pole; 2,50 mm ² ; green-yellow | www.wago.com/2022-106/000-016 |
|  | Nr. articol: 2022-106/000-036 1-conductor female plug; 2.5 mm ² ; 6-pole; 2,50 mm ² ; gray, green-yellow | www.wago.com/2022-106/000-036 |
|  | Nr. articol: 2022-106/000-037 1-conductor female plug; 2.5 mm ² ; 6-pole; 2,50 mm ² ; green-yellow, gray | www.wago.com/2022-106/000-037 |
|  | Nr. articol: 2022-106/000-038 1-conductor female plug; 2.5 mm ² ; 6-pole; 2,50 mm ² ; gray, blue, green-yellow | www.wago.com/2022-106/000-038 |
|  | Nr. articol: 2022-106/000-039 1-conductor female plug; 2.5 mm ² ; 6-pole; 2,50 mm ² ; green-yellow, blue, gray | www.wago.com/2022-106/000-039 |
| | Nr. articol: 2022-106/123-000 1-conductor female plug; Locking lever; 2.5 mm ² ; 6-pole; 2,50 mm ² ; gray | www.wago.com/2022-106/123-000 |
| | Nr. articol: 2022-106/134-000 1-conductor female plug; Strain relief plate; 2.5 mm ² ; 6-pole; 2,50 mm ² ; gray | www.wago.com/2022-106/134-000 |
| | Nr. articol: 2022-106/144-000 1-conductor female plug; Strain relief plate; 2.5 mm ² ; 6-pole; 2,50 mm ² ; gray | www.wago.com/2022-106/144-000 |
|  | Nr. articol: 2022-107 1-conductor female plug; 2.5 mm ² ; 7-pole; 2,50 mm ² ; gray | www.wago.com/2022-107 |
|  | Nr. articol: 2022-107/000-006 1-conductor female plug; 2.5 mm ² ; 7-pole; 2,50 mm ² ; blue | www.wago.com/2022-107/000-006 |

Supus modificărilor.

**Nr. articol:** 2022-107/000-0121-conductor female plug; 2.5 mm²; 7-pole; 2,50 mm²; orangewww.wago.com/2022-107/000-012**Nr. articol:** 2022-107/000-0161-conductor female plug; 2.5 mm²; 7-pole; 2,50 mm²; green-yellowwww.wago.com/2022-107/000-016**Nr. articol:** 2022-107/000-0361-conductor female plug; 2.5 mm²; 7-pole; 2,50 mm²; gray, green-yellowwww.wago.com/2022-107/000-036**Nr. articol:** 2022-107/000-0371-conductor female plug; 2.5 mm²; 7-pole; 2,50 mm²; green-yellow, graywww.wago.com/2022-107/000-037**Nr. articol:** 2022-107/000-0381-conductor female plug; 2.5 mm²; 7-pole; 2,50 mm²; gray, blue, green-yellowwww.wago.com/2022-107/000-038**Nr. articol:** 2022-107/000-0391-conductor female plug; 2.5 mm²; 7-pole; 2,50 mm²; green-yellow, blue, graywww.wago.com/2022-107/000-039**Nr. articol:** 2022-107/123-0001-conductor female plug; Locking lever; 2.5 mm²; 7-pole; 2,50 mm²; graywww.wago.com/2022-107/123-000**Nr. articol:** 2022-107/135-0001-conductor female plug; Strain relief plate; 2.5 mm²; 7-pole; 2,50 mm²; graywww.wago.com/2022-107/135-000**Nr. articol:** 2022-107/145-0001-conductor female plug; Strain relief plate; 2.5 mm²; 7-pole; 2,50 mm²; graywww.wago.com/2022-107/145-000**Nr. articol:** 2022-1081-conductor female plug; 2.5 mm²; 8-pole; 2,50 mm²; graywww.wago.com/2022-108**Nr. articol:** 2022-108/000-0061-conductor female plug; 2.5 mm²; 8-pole; 2,50 mm²; bluewww.wago.com/2022-108/000-006**Nr. articol:** 2022-108/000-0121-conductor female plug; 2.5 mm²; 8-pole; 2,50 mm²; orangewww.wago.com/2022-108/000-012**Nr. articol:** 2022-108/000-0161-conductor female plug; 2.5 mm²; 8-pole; 2,50 mm²; green-yellowwww.wago.com/2022-108/000-016

Supus modificărilor.



Nr. articol: 2022-108/000-036

1-conductor female plug; 2.5 mm²; 8-pole; 2,50 mm²; gray, green-yellow

www.wago.com/2022-108/000-036



Nr. articol: 2022-108/000-037

1-conductor female plug; 2.5 mm²; 8-pole; 2,50 mm²; green-yellow, gray

www.wago.com/2022-108/000-037



Nr. articol: 2022-108/000-038

1-conductor female plug; 2.5 mm²; 8-pole; 2,50 mm²; gray, blue, green-yellow

www.wago.com/2022-108/000-038



Nr. articol: 2022-108/000-039

1-conductor female plug; 2.5 mm²; 8-pole; 2,50 mm²; green-yellow, blue, gray

www.wago.com/2022-108/000-039

Nr. articol: 2022-108/123-000

1-conductor female plug; Locking lever; 2.5 mm²; 8-pole; 2,50 mm²; gray

www.wago.com/2022-108/123-000

Nr. articol: 2022-108/135-000

1-conductor female plug; Strain relief plate; 2.5 mm²; 8-pole; 2,50 mm²; gray

www.wago.com/2022-108/135-000

Nr. articol: 2022-108/145-000

1-conductor female plug; Strain relief plate; 2.5 mm²; 8-pole; 2,50 mm²; gray

www.wago.com/2022-108/145-000



Nr. articol: 2022-109

1-conductor female plug; 2.5 mm²; 9-pole; 2,50 mm²; gray

www.wago.com/2022-109



Nr. articol: 2022-109/000-006

1-conductor female plug; 2.5 mm²; 9-pole; 2,50 mm²; blue

www.wago.com/2022-109/000-006



Nr. articol: 2022-109/000-012

1-conductor female plug; 2.5 mm²; 9-pole; 2,50 mm²; orange

www.wago.com/2022-109/000-012



Nr. articol: 2022-109/000-016

1-conductor female plug; 2.5 mm²; 9-pole; 2,50 mm²; green-yellow

www.wago.com/2022-109/000-016



Nr. articol: 2022-109/000-036

1-conductor female plug; 2.5 mm²; 9-pole; 2,50 mm²; gray, green-yellow

www.wago.com/2022-109/000-036



Nr. articol: 2022-109/000-037









1-conductor female plug; 2.5 mm²; 9-pole; 2,50 mm²; green-yellow, gray

www.wago.com/2022-109/000-037











Supus modificărilor.

**Nr. articol:** 2022-109/000-0381-conductor female plug; 2.5 mm²; 9-pole; 2,50 mm²; gray, blue, green-yellowwww.wago.com/2022-109/000-038**Nr. articol:** 2022-109/000-0391-conductor female plug; 2.5 mm²; 9-pole; 2,50 mm²; green-yellow, blue, graywww.wago.com/2022-109/000-039**Nr. articol:** 2022-109/123-0001-conductor female plug; Locking lever; 2.5 mm²; 9-pole; 2,50 mm²; graywww.wago.com/2022-109/123-000**Nr. articol:** 2022-109/135-0001-conductor female plug; Strain relief plate; 2.5 mm²; 9-pole; 2,50 mm²; graywww.wago.com/2022-109/135-000**Nr. articol:** 2022-109/145-0001-conductor female plug; Strain relief plate; 2.5 mm²; 9-pole; 2,50 mm²; graywww.wago.com/2022-109/145-000**Nr. articol:** 2022-1101-conductor female plug; 2.5 mm²; 10-pole; 2,50 mm²; graywww.wago.com/2022-110**Nr. articol:** 2022-110/000-0061-conductor female plug; 2.5 mm²; 10-pole; 2,50 mm²; bluewww.wago.com/2022-110/000-006**Nr. articol:** 2022-110/000-0121-conductor female plug; 2.5 mm²; 10-pole; 2,50 mm²; orangewww.wago.com/2022-110/000-012**Nr. articol:** 2022-110/000-0161-conductor female plug; 2.5 mm²; 10-pole; 2,50 mm²; green-yellowwww.wago.com/2022-110/000-016**Nr. articol:** 2022-110/000-0361-conductor female plug; 2.5 mm²; 10-pole; 2,50 mm²; gray, green-yellowwww.wago.com/2022-110/000-036**Nr. articol:** 2022-110/000-0371-conductor female plug; 2.5 mm²; 10-pole; 2,50 mm²; green-yellow, graywww.wago.com/2022-110/000-037**Nr. articol:** 2022-110/000-0381-conductor female plug; 2.5 mm²; 10-pole; 2,50 mm²; gray, blue, green-yellowwww.wago.com/2022-110/000-038**Nr. articol:** 2022-110/000-0391-conductor female plug; 2.5 mm²; 10-pole; 2,50 mm²; green-yellow, blue, graywww.wago.com/2022-110/000-039

Supus modificărilor.

| | | |
|--|--|--|
| | Nr. articol: 2022-110/123-000 1-conductor female plug; Locking lever; 2.5 mm ² ; 10-pole; 2,50 mm ² ; gray | www.wago.com/2022-110/123-000 |
| | Nr. articol: 2022-110/135-000 1-conductor female plug; Strain relief plate; 2.5 mm ² ; 10-pole; 2,50 mm ² ; gray | www.wago.com/2022-110/135-000 |
| | Nr. articol: 2022-110/145-000 1-conductor female plug; Strain relief plate; 2.5 mm ² ; 10-pole; 2,50 mm ² ; gray | www.wago.com/2022-110/145-000 |
|  | Nr. articol: 2022-111 1-conductor female plug; 2.5 mm ² ; 11-pole; 2,50 mm ² ; gray | www.wago.com/2022-111 |
|  | Nr. articol: 2022-111/000-006 1-conductor female plug; 2.5 mm ² ; 11-pole; 2,50 mm ² ; blue | www.wago.com/2022-111/000-006 |
|  | Nr. articol: 2022-111/000-012 1-conductor female plug; 2.5 mm ² ; 11-pole; 2,50 mm ² ; orange | www.wago.com/2022-111/000-012 |
|  | Nr. articol: 2022-111/000-016 1-conductor female plug; 2.5 mm ² ; 11-pole; 2,50 mm ² ; green-yellow | www.wago.com/2022-111/000-016 |
|  | Nr. articol: 2022-111/000-036 1-conductor female plug; 2.5 mm ² ; 11-pole; 2,50 mm ² ; gray, green-yellow | www.wago.com/2022-111/000-036 |
|  | Nr. articol: 2022-111/000-037 1-conductor female plug; 2.5 mm ² ; 11-pole; 2,50 mm ² ; green-yellow, gray | www.wago.com/2022-111/000-037 |
|  | Nr. articol: 2022-111/000-038 1-conductor female plug; 2.5 mm ² ; 11-pole; 2,50 mm ² ; gray, blue, green-yellow | www.wago.com/2022-111/000-038 |
|  | Nr. articol: 2022-111/000-039 1-conductor female plug; 2.5 mm ² ; 11-pole; 2,50 mm ² ; green-yellow, blue, gray | www.wago.com/2022-111/000-039 |
| | Nr. articol: 2022-111/126-000 1-conductor female plug; Locking lever; 2.5 mm ² ; 11-pole; 2,50 mm ² ; gray | www.wago.com/2022-111/126-000 |
| | Nr. articol: 2022-111/136-000 1-conductor female plug; Strain relief plate; 2.5 mm ² ; 11-pole; 2,50 mm ² ; gray | www.wago.com/2022-111/136-000 |

Supus modificărilor.

| | | |
|--|--|--|
| | Nr. articol: 2022-111/146-000 1-conductor female plug; Strain relief plate; 2.5 mm ² ; 11-pole; 2,50 mm ² ; gray | www.wago.com/2022-111/146-000 |
|  | Nr. articol: 2022-112 1-conductor female plug; 2.5 mm ² ; 12-pole; 2,50 mm ² ; gray | www.wago.com/2022-112 |
|  | Nr. articol: 2022-112/000-006 1-conductor female plug; 2.5 mm ² ; 12-pole; 2,50 mm ² ; blue | www.wago.com/2022-112/000-006 |
|  | Nr. articol: 2022-112/000-012 1-conductor female plug; 2.5 mm ² ; 12-pole; 2,50 mm ² ; orange | www.wago.com/2022-112/000-012 |
|  | Nr. articol: 2022-112/000-016 1-conductor female plug; 2.5 mm ² ; 12-pole; 2,50 mm ² ; green-yellow | www.wago.com/2022-112/000-016 |
|  | Nr. articol: 2022-112/000-036 1-conductor female plug; 2.5 mm ² ; 12-pole; 2,50 mm ² ; gray, green-yellow | www.wago.com/2022-112/000-036 |
|  | Nr. articol: 2022-112/000-037 1-conductor female plug; 2.5 mm ² ; 12-pole; 2,50 mm ² ; green-yellow, gray | www.wago.com/2022-112/000-037 |
|  | Nr. articol: 2022-112/000-038 1-conductor female plug; 2.5 mm ² ; 12-pole; 2,50 mm ² ; gray, blue, green-yellow | www.wago.com/2022-112/000-038 |
|  | Nr. articol: 2022-112/000-039 1-conductor female plug; 2.5 mm ² ; 12-pole; 2,50 mm ² ; green-yellow, blue, gray | www.wago.com/2022-112/000-039 |
| | Nr. articol: 2022-112/126-000 1-conductor female plug; Locking lever; 2.5 mm ² ; 12-pole; 2,50 mm ² ; gray | www.wago.com/2022-112/126-000 |
| | Nr. articol: 2022-112/136-000 1-conductor female plug; Strain relief plate; 2.5 mm ² ; 12-pole; 2,50 mm ² ; gray | www.wago.com/2022-112/136-000 |
| | Nr. articol: 2022-112/146-000 1-conductor female plug; Strain relief plate; 2.5 mm ² ; 12-pole; 2,50 mm ² ; gray | www.wago.com/2022-112/146-000 |
|  | Nr. articol: 2022-113 1-conductor female plug; 2.5 mm ² ; 13-pole; 2,50 mm ² ; gray | www.wago.com/2022-113 |
|  | Nr. articol: 2022-113/000-006 1-conductor female plug; 2.5 mm ² ; 13-pole; 2,50 mm ² ; blue | www.wago.com/2022-113/000-006 |

Supus modificărilor.



Nr. articol: 2022-113/000-012

1-conductor female plug; 2.5 mm²; 13-pole; 2,50 mm²; orange

www.wago.com/2022-113/000-012



Nr. articol: 2022-113/000-016

1-conductor female plug; 2.5 mm²; 13-pole; 2,50 mm²; green-yellow

www.wago.com/2022-113/000-016



Nr. articol: 2022-113/000-036

1-conductor female plug; 2.5 mm²; 13-pole; 2,50 mm²; gray, green-yellow

www.wago.com/2022-113/000-036



Nr. articol: 2022-113/000-037

1-conductor female plug; 2.5 mm²; 13-pole; 2,50 mm²; green-yellow, gray

www.wago.com/2022-113/000-037



Nr. articol: 2022-113/000-038

1-conductor female plug; 2.5 mm²; 13-pole; 2,50 mm²; gray, blue, green-yellow

www.wago.com/2022-113/000-038



Nr. articol: 2022-113/000-039

1-conductor female plug; 2.5 mm²; 13-pole; 2,50 mm²; green-yellow, blue, gray

www.wago.com/2022-113/000-039

Nr. articol: 2022-113/126-000

1-conductor female plug; Locking lever; 2.5 mm²; 13-pole; 2,50 mm²; gray

www.wago.com/2022-113/126-000

Nr. articol: 2022-113/136-000

1-conductor female plug; Strain relief plate; 2.5 mm²; 13-pole; 2,50 mm²; gray

www.wago.com/2022-113/136-000

Nr. articol: 2022-113/146-000

1-conductor female plug; Strain relief plate; 2.5 mm²; 13-pole; 2,50 mm²; gray

www.wago.com/2022-113/146-000



Nr. articol: 2022-114

1-conductor female plug; 2.5 mm²; 14-pole; 2,50 mm²; gray

www.wago.com/2022-114



Nr. articol: 2022-114/000-006

1-conductor female plug; 2.5 mm²; 14-pole; 2,50 mm²; blue

www.wago.com/2022-114/000-006



Nr. articol: 2022-114/000-012

1-conductor female plug; 2.5 mm²; 14-pole; 2,50 mm²; orange

www.wago.com/2022-114/000-012



Nr. articol: 2022-114/000-016

1-conductor female plug; 2.5 mm²; 14-pole; 2,50 mm²; green-yellow

www.wago.com/2022-114/000-016

Supus modificărilor.



Nr. articol: 2022-114/000-036

1-conductor female plug; 2.5 mm²; 14-pole; 2,50 mm²; gray, green-yellow

www.wago.com/2022-114/000-036



Nr. articol: 2022-114/000-037

1-conductor female plug; 2.5 mm²; 14-pole; 2,50 mm²; green-yellow, gray

www.wago.com/2022-114/000-037



Nr. articol: 2022-114/000-038

1-conductor female plug; 2.5 mm²; 14-pole; 2,50 mm²; gray, blue, green-yellow

www.wago.com/2022-114/000-038



Nr. articol: 2022-114/000-039

1-conductor female plug; 2.5 mm²; 14-pole; 2,50 mm²; green-yellow, blue, gray

www.wago.com/2022-114/000-039

Nr. articol: 2022-114/126-000

1-conductor female plug; Locking lever; 2.5 mm²; 14-pole; 2,50 mm²; gray

www.wago.com/2022-114/126-000

Nr. articol: 2022-114/136-000

1-conductor female plug; Strain relief plate; 2.5 mm²; 14-pole; 2,50 mm²; gray

www.wago.com/2022-114/136-000

Nr. articol: 2022-114/146-000

1-conductor female plug; Strain relief plate; 2.5 mm²; 14-pole; 2,50 mm²; gray

www.wago.com/2022-114/146-000



Nr. articol: 2022-115

1-conductor female plug; 2.5 mm²; 15-pole; 2,50 mm²; gray

www.wago.com/2022-115



Nr. articol: 2022-115/000-006

1-conductor female plug; 2.5 mm²; 15-pole; 2,50 mm²; blue

www.wago.com/2022-115/000-006



Nr. articol: 2022-115/000-012

1-conductor female plug; 2.5 mm²; 15-pole; 2,50 mm²; orange

www.wago.com/2022-115/000-012



Nr. articol: 2022-115/000-016

1-conductor female plug; 2.5 mm²; 15-pole; 2,50 mm²; green-yellow

www.wago.com/2022-115/000-016



Nr. articol: 2022-115/000-036

1-conductor female plug; 2.5 mm²; 15-pole; 2,50 mm²; gray, green-yellow

www.wago.com/2022-115/000-036



Nr. articol: 2022-115/000-037

1-conductor female plug; 2.5 mm²; 15-pole; 2,50 mm²; green-yellow, gray

www.wago.com/2022-115/000-037

















Supus modificărilor.

**Nr. articol:** 2022-115/000-0381-conductor female plug; 2.5 mm²; 15-pole; 2,50 mm²; gray, blue, green-yellowwww.wago.com/2022-115/000-038**Nr. articol:** 2022-115/000-0391-conductor female plug; 2.5 mm²; 15-pole; 2,50 mm²; green-yellow, blue, graywww.wago.com/2022-115/000-039**Nr. articol:** 2022-115/127-0001-conductor female plug; Locking lever; 2.5 mm²; 15-pole; 2,50 mm²; graywww.wago.com/2022-115/127-000**Nr. articol:** 2022-115/137-0001-conductor female plug; Strain relief plate; 2.5 mm²; 15-pole; 2,50 mm²; graywww.wago.com/2022-115/137-000**Nr. articol:** 2022-115/147-0001-conductor female plug; Strain relief plate; 2.5 mm²; 15-pole; 2,50 mm²; graywww.wago.com/2022-115/147-000**Coding****Nr. articol:** 2022-100

Carrier with 6 coding pins; for coding of female plugs; orange

www.wago.com/2022-100**General accessories****Nr. articol:** 2022-161Start module for 1-conductor female connector; with integrated end plate; 2.5 mm²; 1-pole; 2,50 mm²; graywww.wago.com/2022-161**Nr. articol:** 2022-162Start module for 1-conductor female connector; with integrated end plate; 2.5 mm²; 1-pole; 2,50 mm²; orangewww.wago.com/2022-162**Nr. articol:** 2022-164Start module for 1-conductor female connector; with integrated end plate; 2.5 mm²; 1-pole; 2,50 mm²; bluewww.wago.com/2022-164**Nr. articol:** 2022-167Start module for 1-conductor female connector; with integrated end plate; 2.5 mm²; 1-pole; 2,50 mm²; green-yellowwww.wago.com/2022-167**Nr. articol:** 2022-171Center module for 1-conductor female connector; 2.5 mm²; 1-pole; 2,50 mm²; graywww.wago.com/2022-171**Nr. articol:** 2022-172Center module for 1-conductor female connector; 2.5 mm²; 1-pole; 2,50 mm²; orangewww.wago.com/2022-172**Nr. articol:** 2022-174Center module for 1-conductor female connector; 2.5 mm²; 1-pole; 2,50 mm²; bluewww.wago.com/2022-174**Nr. articol:** 2022-177Center module for 1-conductor female connector; 2.5 mm²; 1-pole; 2,50 mm²; green-yellowwww.wago.com/2022-177**Nr. articol:** 2022-181End module for 1-conductor female connector; 2.5 mm²; 1-pole; 2,50 mm²; graywww.wago.com/2022-181

Supus modificărilor.

| | | |
|--|--|--|
|  | Nr. articol: 2022-182 End module for 1-conductor female connector; 2.5 mm ² ; 1-pole; 2,50 mm ² ; orange | www.wago.com/2022-182 |
|  | Nr. articol: 2022-184 End module for 1-conductor female connector; 2.5 mm ² ; 1-pole; 2,50 mm ² ; blue | www.wago.com/2022-184 |
|  | Nr. articol: 2022-187 End module for 1-conductor female connector; 2.5 mm ² ; 1-pole; 2,50 mm ² ; green-yellow | www.wago.com/2022-187 |
| tools | | |
|  | Nr. articol: 210-720 Operating tool; Blade: 3.5 x 0.5 mm; with a partially insulated shaft | www.wago.com/210-720 |
| check | | |
|  | Nr. articol: 2002-511 Modular TOPJOB®S connector; modular; for jumper contact slot; 1-pole; 2,50 mm ² ; gray | www.wago.com/2002-511 |
|  | Nr. articol: 2002-549 Spacer module; modular; e.g., for bridging commoned terminal blocks; gray | www.wago.com/2002-549 |
|  | Nr. articol: 2002-552 Modular TOPJOB®S connector; modular; for jumper contact slot; 2-pole; 2,50 mm ² ; gray | www.wago.com/2002-552 |
|  | Nr. articol: 2002-553 Modular TOPJOB®S connector; modular; for jumper contact slot; 3-pole; 2,50 mm ² ; gray | www.wago.com/2002-553 |
|  | Nr. articol: 2002-554 Modular TOPJOB®S connector; modular; for jumper contact slot; 4-pole; 2,50 mm ² ; gray | www.wago.com/2002-554 |
|  | Nr. articol: 2002-555 Modular TOPJOB®S connector; modular; for jumper contact slot; 5-pole; 2,50 mm ² ; gray | www.wago.com/2002-555 |
|  | Nr. articol: 2002-556 Modular TOPJOB®S connector; modular; for jumper contact slot; 6-pole; 2,50 mm ² ; gray | www.wago.com/2002-556 |
|  | Nr. articol: 2002-557 Modular TOPJOB®S connector; modular; for jumper contact slot; 7-pole; 2,50 mm ² ; gray | www.wago.com/2002-557 |
|  | Nr. articol: 2002-558 Modular TOPJOB®S connector; modular; for jumper contact slot; 8-pole; 2,50 mm ² ; gray | www.wago.com/2002-558 |
|  | Nr. articol: 2002-559 Modular TOPJOB®S connector; modular; for jumper contact slot; 9-pole; 2,50 mm ² ; gray | www.wago.com/2002-559 |
|  | Nr. articol: 2002-560 Modular TOPJOB®S connector; modular; for jumper contact slot; 10-pole; 2,50 mm ² ; gray | www.wago.com/2002-560 |
|  | Nr. articol: 2009-174 Test plug adapter; for 4 mm Ø test plugs; for testing TOPJOB®S rail-mounted terminal blocks; gray | www.wago.com/2009-174 |
|  | Nr. articol: 2009-182 Testing tap; for max. 2.5 mm ² ; tool-free connection for individual test wires 0.08 - 2.5 mm; gray | www.wago.com/2009-182 |

Supus modificărilor.





Nr. articol: 859-500
Test pin; 1 mm Ø; with solder connection for test wire

www.wago.com/859-500

ferrule

| | | |
|---|---|--|
|  | Nr. articol: 216-241 Ferrule; Sleeve for 0.5 mm ² / 20 AWG; insulated; electro-tin plated; electrolytic copper; gastight crimped; acc. to DIN 46228, Part 4/09.90; white | www.wago.com/216-241 |
|  | Nr. articol: 216-242 Ferrule; Sleeve for 0.75 mm ² / 18 AWG; insulated; electro-tin plated; electrolytic copper; gastight crimped; acc. to DIN 46228, Part 4/09.90; gray | www.wago.com/216-242 |
|  | Nr. articol: 216-243 Ferrule; Sleeve for 1 mm ² / AWG 18; insulated; electro-tin plated; electrolytic copper; gastight crimped; acc. to DIN 46228, Part 4/09.90; red | www.wago.com/216-243 |
|  | Nr. articol: 216-244 Ferrule; Sleeve for 1.5 mm ² / AWG 16; insulated; electro-tin plated; electrolytic copper; gastight crimped; acc. to DIN 46228, Part 4/09.90; black | www.wago.com/216-244 |
|  | Nr. articol: 216-246 Ferrule; Sleeve for 2.5 mm ² / AWG 14; insulated; electro-tin plated; electrolytic copper; gastight crimped; acc. to DIN 46228, Part 4/09.90; blue | www.wago.com/216-246 |
|  | Nr. articol: 216-262 Ferrule; Sleeve for 0.75 mm ² / 18 AWG; insulated; electro-tin plated; electrolytic copper; gastight crimped; acc. to DIN 46228, Part 4/09.90; gray | www.wago.com/216-262 |
|  | Nr. articol: 216-263 Ferrule; Sleeve for 1 mm ² / AWG 18; insulated; electro-tin plated; electrolytic copper; gastight crimped; acc. to DIN 46228, Part 4/09.90; red | www.wago.com/216-263 |
|  | Nr. articol: 216-264 Ferrule; Sleeve for 1.5 mm ² / AWG 16; insulated; electro-tin plated; electrolytic copper; gastight crimped; acc. to DIN 46228, Part 4/09.90; black | www.wago.com/216-264 |
|  | Nr. articol: 216-266 Ferrule; Sleeve for 2.5 mm ² / AWG 14; insulated; electro-tin plated; electrolytic copper; gastight crimped; acc. to DIN 46228, Part 4/09.90; blue | www.wago.com/216-266 |
|  | Nr. articol: 216-284 Ferrule; Sleeve for 1.5 mm ² / AWG 16; insulated; electro-tin plated; electrolytic copper; gastight crimped; acc. to DIN 46228, Part 4/09.90; black | www.wago.com/216-284 |
|  | Nr. articol: 216-286 Ferrule; Sleeve for 2.5 mm ² / AWG 14; insulated; electro-tin plated; electrolytic copper; gastight crimped; acc. to DIN 46228, Part 4/09.90; blue | www.wago.com/216-286 |















Carrier rail

| | | |
|--|---|--|
|  | Nr. articol: 210-112 Steel carrier rail; 35 x 7.5 mm; 1 mm thick; 2 m long; slotted; according to EN 60715; "Hole width 25 mm | www.wago.com/210-112 |
|  | Nr. articol: 210-113 Steel carrier rail; 35 x 7.5 mm; 1 mm thick; 2 m long; unslotted; according to EN 60715 | www.wago.com/210-113 |
|  | Nr. articol: 210-114 Steel carrier rail; 35 x 15 mm; 1.5 mm thick; 2 m long; unslotted; similar to EN 60715 | www.wago.com/210-114 |
| | Nr. articol: 210-115 | |















Supus modificărilor.

WAGO Kontakttechnik GmbH & Co. KG
/Representative Office Romania
Sos. Pipera-Tunari nr. 1/1
building 1, 2nd floor | 077190 Voluntari, Ilfov
Tel.: +40-(0)31 421 85 68 | Email: info-RO@wago.com

Aveți întrebări despre produsele noastre?
Vă stăm la dispoziție pentru preluarea apelului la +40 (0) 31 421 85 68.















| | | |
|--|---|--|
|  | Steel carrier rail; 35 x 7.5 mm; 1 mm thick; 2 m long; slotted; according to EN 60715; "Hole width 18 mm | www.wago.com/210-115 |
|  | Nr. articol: 210-118 Steel carrier rail; 35 x 15 mm; 2.3 mm thick; 2 m long; unslotted; according to EN 60715 | www.wago.com/210-118 |
|  | Nr. articol: 210-196 Aluminum carrier rail; 35 x 8.2 mm; 1.6 mm thick; 2 m long; unslotted; similar to EN 60715; silver-colored | www.wago.com/210-196 |
|  | Nr. articol: 210-197 Steel carrier rail; 35 x 15 mm; 1.5 mm thick; 2 m long; slotted; similar to EN 60715 | www.wago.com/210-197 |
|  | Nr. articol: 210-198 Copper carrier rail; 35 x 15 mm; 2.3 mm thick; 2 m long; unslotted; according to EN 60715; copper-colored | www.wago.com/210-198 |
| Push-In type wire jumper | | |
|  | Nr. articol: 2009-412 Push-in type wire jumper; insulated; wire length 60 mm; Conductor cross section 1.5 mm ² ; suitable for 2001, 2002, 2003 and 2022 Series rail-mounted terminal blocks; black | www.wago.com/2009-412 |
|  | Nr. articol: 2009-414 Push-in type wire jumper; insulated; wire length 110 mm; Conductor cross section 1.5 mm ² ; suitable for 2001, 2002, 2003 and 2022 Series rail-mounted terminal blocks; black | www.wago.com/2009-414 |
|  | Nr. articol: 2009-414/000-005 Push-in type wire jumper; insulated; wire length 110 mm; Conductor cross section 1.5 mm ² ; suitable for 2001, 2002, 2003 and 2022 Series rail-mounted terminal blocks; red | www.wago.com/2009-414/000-005 |
|  | Nr. articol: 2009-414/000-006 Push-in type wire jumper; insulated; wire length 110 mm; Conductor cross section 1.5 mm ² ; suitable for 2001, 2002, 2003 and 2022 Series rail-mounted terminal blocks; blue | www.wago.com/2009-414/000-006 |
|  | Nr. articol: 2009-416 Push-in type wire jumper; insulated; wire length 250 mm; Conductor cross section 1.5 mm ² ; suitable for 2001, 2002, 2003 and 2022 Series rail-mounted terminal blocks; black | www.wago.com/2009-416 |
| Protective Warning Marker | | |
|  | Nr. articol: 2002-115 Protective warning marker; with high-voltage symbol, black; for 5 terminal blocks; yellow | www.wago.com/2002-115 |
| Marking accessories | | |
|  | Nr. articol: 2002-161 Adaptor | www.wago.com/2002-161 |
|  | Nr. articol: 2009-110 Marking strips; on reel; not stretchable; plain; snap-on type; white | www.wago.com/2009-110 |
|  | Nr. articol: 2009-115 WMB-Inline; for Smart Printer; 1500 pieces on roll; stretchable 5 - 5.2 mm; plain; snap-on type; white | www.wago.com/2009-115 |
|  | Nr. articol: 2009-115/000-002 WMB-Inline; for Smart Printer; 1500 pieces on roll; stretchable 5 - 5.2 mm; plain; snap-on type; yellow | www.wago.com/2009-115/000-002 |

Supus modificărilor.

| | | |
|--|--|--|
|  | Nr. articol: 2009-115/000-005 WMB-Inline; for Smart Printer; 1500 pieces on roll; stretchable 5 - 5.2 mm; plain; snap-on type; red | www.wago.com/2009-115/000-005 |
|  | Nr. articol: 2009-115/000-006 WMB-Inline; for Smart Printer; 1500 pieces on roll; stretchable 5 - 5.2 mm; plain; snap-on type; blue | www.wago.com/2009-115/000-006 |
|  | Nr. articol: 2009-115/000-007 WMB-Inline; for Smart Printer; 1500 pieces on roll; stretchable 5 - 5.2 mm; plain; snap-on type; gray | www.wago.com/2009-115/000-007 |
|  | Nr. articol: 2009-115/000-012 WMB-Inline; for Smart Printer; 1500 pieces on roll; stretchable 5 - 5.2 mm; plain; snap-on type; orange | www.wago.com/2009-115/000-012 |
|  | Nr. articol: 2009-115/000-017 WMB-Inline; for Smart Printer; 1500 pieces on roll; stretchable 5 - 5.2 mm; plain; snap-on type; light green | www.wago.com/2009-115/000-017 |
|  | Nr. articol: 2009-115/000-023 WMB-Inline; for Smart Printer; 1500 pieces on roll; stretchable 5 - 5.2 mm; plain; snap-on type; green | www.wago.com/2009-115/000-023 |
|  | Nr. articol: 2009-115/000-024 WMB-Inline; for Smart Printer; 1500 pieces on roll; stretchable 5 - 5.2 mm; plain; snap-on type; violet | www.wago.com/2009-115/000-024 |
|  | Nr. articol: 2009-145 Mini-WSB Inline; for Smart Printer; 1700 pieces on roll; stretchable 5 - 5.2 mm; plain; snap-on type; white | www.wago.com/2009-145 |
|  | Nr. articol: 2009-145/000-002 Mini-WSB Inline; for Smart Printer; 1700 pieces on roll; stretchable 5 - 5.2 mm; plain; snap-on type; yellow | www.wago.com/2009-145/000-002 |
|  | Nr. articol: 2009-145/000-005 Mini-WSB Inline; for Smart Printer; 1700 pieces on roll; stretchable 5 - 5.2 mm; plain; snap-on type; red | www.wago.com/2009-145/000-005 |
|  | Nr. articol: 2009-145/000-006 Mini-WSB Inline; for Smart Printer; 1700 pieces on roll; stretchable 5 - 5.2 mm; plain; snap-on type; blue | www.wago.com/2009-145/000-006 |
|  | Nr. articol: 2009-145/000-007 Mini-WSB Inline; for Smart Printer; 1700 pieces on roll; stretchable 5 - 5.2 mm; plain; snap-on type; gray | www.wago.com/2009-145/000-007 |
|  | Nr. articol: 2009-145/000-012 Mini-WSB Inline; for Smart Printer; 1700 pieces on roll; stretchable 5 - 5.2 mm; plain; snap-on type; orange | www.wago.com/2009-145/000-012 |
|  | Nr. articol: 2009-145/000-023 Mini-WSB Inline; for Smart Printer; 1700 pieces on roll; stretchable 5 - 5.2 mm; plain; snap-on type; | www.wago.com/2009-145/000-023 |

Supus modificărilor.

green















| | | |
|--|--|--|
|  | Nr. articol: 2009-145/000-024 Mini-WSB Inline; for Smart Printer; 1700 pieces on roll; stretchable 5 - 5.2 mm; plain; snap-on type; violet | www.wago.com/2009-145/000-024 |
|  | Nr. articol: 2009-191 Group marker carrier | www.wago.com/2009-191 |
|  | Nr. articol: 2009-192 Group marker carrier | www.wago.com/2009-192 |
|  | Nr. articol: 2009-193 Group marker carrier | www.wago.com/2009-193 |
|  | Nr. articol: 2009-198 Adaptor | www.wago.com/2009-198 |
|  | Nr. articol: 248-501 Miniature WSB Quick marking system; plain; Marker width 5 mm; 10 strips with 10 markers per card | www.wago.com/248-501 |
|  | Nr. articol: 248-501/000-002 Mini-WSB marking card; as card; not stretchable; plain; snap-on type; yellow | www.wago.com/248-501/000-002 |
|  | Nr. articol: 248-501/000-005 Mini-WSB marking card; as card; not stretchable; plain; snap-on type; red | www.wago.com/248-501/000-005 |
|  | Nr. articol: 248-501/000-006 Mini-WSB marking card; as card; not stretchable; plain; snap-on type; blue | www.wago.com/248-501/000-006 |
|  | Nr. articol: 248-501/000-007 Mini-WSB marking card; as card; not stretchable; plain; snap-on type; gray | www.wago.com/248-501/000-007 |
|  | Nr. articol: 248-501/000-012 Mini-WSB marking card; as card; not stretchable; plain; snap-on type; orange | www.wago.com/248-501/000-012 |
|  | Nr. articol: 248-501/000-017 Mini-WSB marking card; as card; not stretchable; plain; snap-on type; light green | www.wago.com/248-501/000-017 |
|  | Nr. articol: 248-501/000-023 Mini-WSB marking card; as card; not stretchable; plain; snap-on type; green | www.wago.com/248-501/000-023 |
|  | Nr. articol: 248-501/000-024 Mini-WSB marking card; as card; not stretchable; plain; snap-on type; violet | www.wago.com/248-501/000-024 |

Nr. articol: 793-501

Supus modificărilor.

WAGO Kontakttechnik GmbH & Co. KG
/Representative Office Romania
Sos. Pipera-Tunari nr. 1/1
building 1, 2nd floor | 077190 Voluntari, Ilfov
Tel.: +40-(0)31 421 85 68 | Email: info-RO@wago.com

Aveți întrebări despre produsele noastre?
Vă stăm la dispoziție pentru preluarea apelului la +40 (0) 31 421 85 68.

| | | |
|--|--|--|
|  | WMB marking card; as card; not stretchable; plain; snap-on type; white | www.wago.com/793-501 |
|  | Nr. articol: 793-501/000-002 WMB marking card; as card; not stretchable; plain; snap-on type; yellow | www.wago.com/793-501/000-002 |
|  | Nr. articol: 793-501/000-005 WMB marking card; as card; not stretchable; plain; snap-on type; red | www.wago.com/793-501/000-005 |
|  | Nr. articol: 793-501/000-006 WMB marking card; as card; not stretchable; plain; snap-on type; blue | www.wago.com/793-501/000-006 |
|  | Nr. articol: 793-501/000-007 WMB marking card; as card; not stretchable; plain; snap-on type; gray | www.wago.com/793-501/000-007 |
|  | Nr. articol: 793-501/000-012 WMB marking card; as card; not stretchable; plain; snap-on type; orange | www.wago.com/793-501/000-012 |
|  | Nr. articol: 793-501/000-017 WMB marking card; as card; not stretchable; plain; snap-on type; light green | www.wago.com/793-501/000-017 |
|  | Nr. articol: 793-501/000-023 WMB marking card; as card; not stretchable; plain; snap-on type; green | www.wago.com/793-501/000-023 |
|  | Nr. articol: 793-501/000-024 WMB marking card; as card; not stretchable; plain; snap-on type; violet | www.wago.com/793-501/000-024 |
|  | Nr. articol: 793-5501 WMB marking card; as card; for terminal block width 5 - 17.5 mm; stretchable 5 - 5.2 mm; plain; snap-on type; white | www.wago.com/793-5501 |
|  | Nr. articol: 793-5501/000-002 WMB marking card; as card; for terminal block width 5 - 17.5 mm; stretchable 5 - 5.2 mm; plain; snap-on type; yellow | www.wago.com/793-5501/000-002 |
|  | Nr. articol: 793-5501/000-005 WMB marking card; as card; for terminal block width 5 - 17.5 mm; stretchable 5 - 5.2 mm; plain; snap-on type; red | www.wago.com/793-5501/000-005 |
|  | Nr. articol: 793-5501/000-006 WMB marking card; as card; for terminal block width 5 - 17.5 mm; stretchable 5 - 5.2 mm; plain; snap-on type; blue | www.wago.com/793-5501/000-006 |
|  | Nr. articol: 793-5501/000-007 WMB marking card; as card; for terminal block width 5 - 17.5 mm; stretchable 5 - 5.2 mm; plain; snap-on type; gray | www.wago.com/793-5501/000-007 |

Supus modificărilor.

**Nr. articol: 793-5501/000-012**

WMB marking card; as card; for terminal block width 5 - 17.5 mm; stretchable 5 - 5.2 mm; plain; snap-on type; orange

www.wago.com/793-5501/000-012**Nr. articol: 793-5501/000-014**

WMB marking card; as card; for terminal block width 5 - 17.5 mm; stretchable 5 - 5.2 mm; plain; snap-on type; brown

www.wago.com/793-5501/000-014**Nr. articol: 793-5501/000-017**

WMB marking card; as card; for terminal block width 5 - 17.5 mm; stretchable 5 - 5.2 mm; plain; snap-on type; green

www.wago.com/793-5501/000-017**Nr. articol: 793-5501/000-023**

WMB marking card; as card; for terminal block width 5 - 17.5 mm; stretchable 5 - 5.2 mm; plain; snap-on type; light green

www.wago.com/793-5501/000-023**Nr. articol: 793-5501/000-024**

WMB marking card; as card; for terminal block width 5 - 17.5 mm; stretchable 5 - 5.2 mm; plain; snap-on type; violet

www.wago.com/793-5501/000-024**Jumper****Nr. articol: 2002-400**

Adjacent jumper for continuous commoning; insulated; 2-way; Nominal current 25 A; light gray

www.wago.com/2002-400**Nr. articol: 2002-402**

Push-in type jumper bar; insulated; 2-way; Nominal current 25 A; light gray

www.wago.com/2002-402**Nr. articol: 2002-402/000-005**

Push-in type jumper bar; insulated; 2-way; Nominal current 25 A; red

www.wago.com/2002-402/000-005**Nr. articol: 2002-402/000-006**

Push-in type jumper bar; insulated; 2-way; Nominal current 25 A; blue

www.wago.com/2002-402/000-006**Nr. articol: 2002-403**

Push-in type jumper bar; insulated; 3-way; Nominal current 25 A; light gray

www.wago.com/2002-403**Nr. articol: 2002-403/000-005**

Push-in type jumper bar; insulated; 3-way; Nominal current 25 A; red

www.wago.com/2002-403/000-005**Nr. articol: 2002-403/000-006**

Push-in type jumper bar; insulated; 3-way; Nominal current 25 A; blue

www.wago.com/2002-403/000-006**Nr. articol: 2002-404**















Push-in type jumper bar; insulated; 4-way; Nominal current 25 A; light gray

www.wago.com/2002-404**Nr. articol: 2002-404/000-005**















Push-in type jumper bar; insulated; 4-way; Nominal current 25 A; red

www.wago.com/2002-404/000-005

Supus modificărilor.

| | | |
|--|---|--|
|  | Nr. articol: 2002-404/000-006 Push-in type jumper bar; insulated; 4-way; Nominal current 25 A; blue | www.wago.com/2002-404/000-006 |
|  | Nr. articol: 2002-405 Push-in type jumper bar; insulated; 5-way; Nominal current 25 A; light gray | www.wago.com/2002-405 |
|  | Nr. articol: 2002-405/000-005 Push-in type jumper bar; insulated; 5-way; Nominal current 25 A; red | www.wago.com/2002-405/000-005 |
|  | Nr. articol: 2002-405/000-006 Push-in type jumper bar; insulated; 5-way; Nominal current 25 A; blue | www.wago.com/2002-405/000-006 |
|  | Nr. articol: 2002-405/011-000 Star point jumper; insulated; 3-way (1-3-5); IN = IN terminal block; light gray | www.wago.com/2002-405/011-000 |
|  | Nr. articol: 2002-406 Push-in type jumper bar; insulated; 6-way; Nominal current 25 A; light gray | www.wago.com/2002-406 |
|  | Nr. articol: 2002-406/000-005 Push-in type jumper bar; insulated; 6-way; Nominal current 25 A; red | www.wago.com/2002-406/000-005 |
|  | Nr. articol: 2002-406/000-006 Push-in type jumper bar; insulated; 6-way; Nominal current 25 A; blue | www.wago.com/2002-406/000-006 |
|  | Nr. articol: 2002-406/020-000 Delta jumper; insulated; 1-2 3-4 5-6; IN = IN terminal block; light gray | www.wago.com/2002-406/020-000 |
|  | Nr. articol: 2002-407 Push-in type jumper bar; insulated; 7-way; Nominal current 25 A; light gray | www.wago.com/2002-407 |
|  | Nr. articol: 2002-407/000-005 Push-in type jumper bar; insulated; 7-way; Nominal current 25 A; red | www.wago.com/2002-407/000-005 |
|  | Nr. articol: 2002-407/000-006 Push-in type jumper bar; insulated; 7-way; Nominal current 25 A; blue | www.wago.com/2002-407/000-006 |
|  | Nr. articol: 2002-408 Push-in type jumper bar; insulated; 8-way; Nominal current 25 A; light gray | www.wago.com/2002-408 |
|  | Nr. articol: 2002-408/000-005 Push-in type jumper bar; insulated; 8-way; Nominal current 25 A; red | www.wago.com/2002-408/000-005 |













Supus modificărilor.

| | | |
|--|--|--|
|  | Nr. articol: 2002-408/000-006 Push-in type jumper bar; insulated; 8-way; Nominal current 25 A; blue | www.wago.com/2002-408/000-006 |
|  | Nr. articol: 2002-409 Push-in type jumper bar; insulated; 9-way; Nominal current 25 A; light gray | www.wago.com/2002-409 |
|  | Nr. articol: 2002-409/000-005 Push-in type jumper bar; insulated; 9-way; Nominal current 25 A; red | www.wago.com/2002-409/000-005 |
|  | Nr. articol: 2002-409/000-006 Push-in type jumper bar; insulated; 9-way; Nominal current 25 A; blue | www.wago.com/2002-409/000-006 |
|  | Nr. articol: 2002-410 Push-in type jumper bar; insulated; 10-way; Nominal current 25 A; light gray | www.wago.com/2002-410 |
|  | Nr. articol: 2002-410/000-005 Push-in type jumper bar; insulated; 10-way; Nominal current 25 A; red | www.wago.com/2002-410/000-005 |
|  | Nr. articol: 2002-410/000-006 Push-in type jumper bar; insulated; 10-way; Nominal current 25 A; blue | www.wago.com/2002-410/000-006 |
|  | Nr. articol: 2002-423 Adjacent jumper for continuous commoning; insulated; from 1 to 3; Nominal current 25 A; light gray | www.wago.com/2002-423 |
|  | Nr. articol: 2002-423/000-005 Adjacent jumper for continuous commoning; insulated; from 1 to 3; Nominal current 25 A; red | www.wago.com/2002-423/000-005 |
|  | Nr. articol: 2002-423/000-006 Adjacent jumper for continuous commoning; insulated; from 1 to 3; Nominal current 25 A; blue | www.wago.com/2002-423/000-006 |
|  | Nr. articol: 2002-433 Push-in type jumper bar; insulated; from 1 to 3; Nominal current 25 A; light gray | www.wago.com/2002-433 |
|  | Nr. articol: 2002-434 Push-in type jumper bar; insulated; from 1 to 4; Nominal current 25 A; light gray | www.wago.com/2002-434 |
|  | Nr. articol: 2002-435 Push-in type jumper bar; insulated; from 1 to 5; Nominal current 25 A; light gray | www.wago.com/2002-435 |
|  | Nr. articol: 2002-436 Push-in type jumper bar; insulated; from 1 to 6; Nominal current 25 A; light gray | www.wago.com/2002-436 |
|  | Nr. articol: 2002-437 Push-in type jumper bar; insulated; from 1 to 7; Nominal current 25 A; light gray | www.wago.com/2002-437 |









Supus modificărilor.

WAGO Kontakttechnik GmbH & Co. KG
/Representative Office Romania
Sos. Pipera-Tunari nr. 1/1
building 1, 2nd floor | 077190 Voluntari, Ilfov
Tel.: +40-(0)31 421 85 68 | Email: info-RO@wago.com

Aveți întrebări despre produsele noastre?
Vă stăm la dispoziție pentru preluarea apelului la +40 (0) 31 421 85 68.

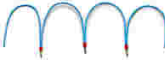
| | | |
|--|--|--|
|  | Nr. articol: 2002-438 Push-in type jumper bar; insulated; from 1 to 8; Nominal current 25 A; light gray | www.wago.com/2002-438 |
|  | Nr. articol: 2002-439 Push-in type jumper bar; insulated; from 1 to 9; Nominal current 25 A; light gray | www.wago.com/2002-439 |
|  | Nr. articol: 2002-440 Push-in type jumper bar; insulated; from 1 to 10; Nominal current 25 A; light gray | www.wago.com/2002-440 |
|  | Nr. articol: 2002-472 Staggered jumper; insulated; 2-way; Nominal current 25 A; suitable for 2002 and 2003 Series rail-mounted terminal blocks; light gray | www.wago.com/2002-472 |
|  | Nr. articol: 2002-473 Staggered jumper; insulated; 3-way; Nominal current 25 A; suitable for 2002 and 2003 Series rail-mounted terminal blocks; light gray | www.wago.com/2002-473 |
| | Nr. articol: 2002-473/011-000 Ready-made staggered jumper; insulated; 2-way (1-3); Nominal current 25 A; with contact lugs broken off at the factory and circuit marking; light gray | www.wago.com/2002-473/011-000 |
|  | Nr. articol: 2002-474 Staggered jumper; insulated; 4-way; Nominal current 25 A; suitable for 2002 and 2003 Series rail-mounted terminal blocks; light gray | www.wago.com/2002-474 |
|  | Nr. articol: 2002-475 Staggered jumper; insulated; 5-way; Nominal current 25 A; suitable for 2002 and 2003 Series rail-mounted terminal blocks; light gray | www.wago.com/2002-475 |
| | Nr. articol: 2002-475/011-000 Ready-made staggered jumper; insulated; 3-way (1-3-5); Nominal current 25 A; with contact lugs broken off at the factory and circuit marking; light gray | www.wago.com/2002-475/011-000 |
|  | Nr. articol: 2002-476 Staggered jumper; insulated; 6-way; Nominal current 25 A; suitable for 2002 and 2003 Series rail-mounted terminal blocks; light gray | www.wago.com/2002-476 |
|  | Nr. articol: 2002-477 Staggered jumper; insulated; 7-way; Nominal current 25 A; suitable for 2002 and 2003 Series rail-mounted terminal blocks; light gray | www.wago.com/2002-477 |
|  | Nr. articol: 2002-477/011-000 Ready-made staggered jumper; insulated; 1-3-5-7; Nominal current 25 A; with contact lugs broken off at the factory and circuit marking; light gray | www.wago.com/2002-477/011-000 |
|  | Nr. articol: 2002-478 Staggered jumper; insulated; 8-way; Nominal current 25 A; suitable for 2002 and 2003 Series rail-mounted terminal blocks; light gray | www.wago.com/2002-478 |
|  | Nr. articol: 2002-479 Staggered jumper; insulated; 9-way; Nominal current 25 A; suitable for 2002 and 2003 Series rail-mounted terminal blocks; light gray | www.wago.com/2002-479 |
| | Nr. articol: 2002-479/011-000 Ready-made staggered jumper; insulated; 1-3-5-7-9; Nominal current 25 A; with contact lugs broken off at the factory and circuit marking; light gray | www.wago.com/2002-479/011-000 |
| | Nr. articol: 2002-480 | |

Supus modificărilor.

| | | |
|--|---|--|
|  | Staggered jumper; insulated; 10-way; Nominal current 25 A; suitable for 2002 and 2003 Series rail-mounted terminal blocks; light gray | www.wago.com/2002-480 |
|  | Nr. articol: 2002-481 Staggered jumper; insulated; 11-way; Nominal current 25 A; suitable for 2002 and 2003 Series rail-mounted terminal blocks; light gray | www.wago.com/2002-481 |
| | Nr. articol: 2002-481/011-000 Ready-made staggered jumper; insulated; 1-3-5-7-9-11; Nominal current 25 A; with contact lugs broken off at the factory and circuit marking; light gray | www.wago.com/2002-481/011-000 |
|  | Nr. articol: 2002-482 Staggered jumper; insulated; 12-way; Nominal current 25 A; suitable for 2002 and 2003 Series rail-mounted terminal blocks; light gray | www.wago.com/2002-482 |
|  | Nr. articol: 210-103 Wire commoning chain; insulated; 50 connections; black | www.wago.com/210-103 |
|  | Nr. articol: 210-123 Wire commoning chain; insulated; 50 connections | www.wago.com/210-123 |
| End plate | | |
|  | Nr. articol: 2022-1291 End and intermediate plate; 1 mm thick; gray | www.wago.com/2022-1291 |
|  | Nr. articol: 2022-1292 End and intermediate plate; 1 mm thick; orange | www.wago.com/2022-1292 |
| Insulation stop | | |
|  | Nr. articol: 2002-171 Insulation stop; 0.25 - 0.5 mm ² ; 5 pieces/strip; light gray | www.wago.com/2002-171 |
|  | Nr. articol: 2002-172 Insulation stop; 0.75 - 1 mm ² ; 5 pieces/strip; dark gray | www.wago.com/2002-172 |

Descărcări

Documentation

Additional Information

| | | | |
|------------------------|-------------|---------------|------------|
| Technical explanations | Apr 3, 2019 | pdf 2,1 MB | Descărcare |
|------------------------|-------------|---------------|------------|

CAD/CAE-Data

CAD data

| | | |
|------------------------|-----|------------|
| 2D/3D Models 2022-1201 | URL | Descărcare |
|------------------------|-----|------------|

CAE data

EPLAN Data Portal 2022-1201

Supus modificărilor.

WAGO Kontakttechnik GmbH & Co. KG
/Representative Office Romania
Sos. Pipera-Tunari nr. 1/1
building 1, 2nd floor | 077190 Voluntari, Ilfov
Tel.: +40-(0)31 421 85 68 | Email: info-RO@wago.com

Aveți întrebări despre produsele noastre?
Vă stăm la dispoziție pentru preluarea apelului la +40 (0) 31 421 85 68.

Installation Notes

Installation

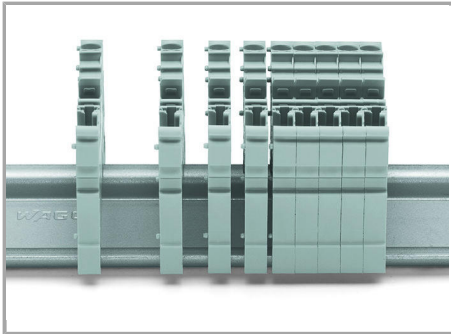

Snap individual carrier terminal blocks onto the carrier rail and slide together.

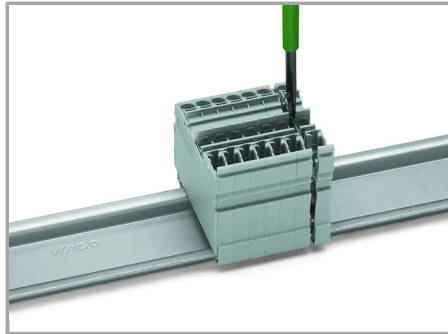

Open the assembly by laterally sliding a block via operating tool (3.5 x 0.5 mm blade).

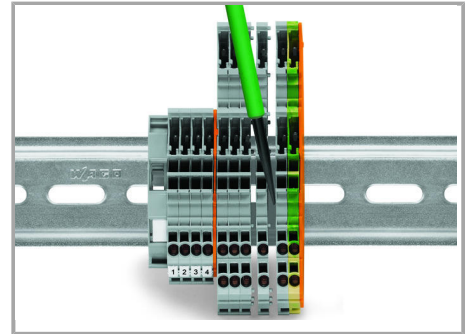

Separate terminal block assembly and slide individual terminal blocks laterally using an operating tool.

Inserting a conductor

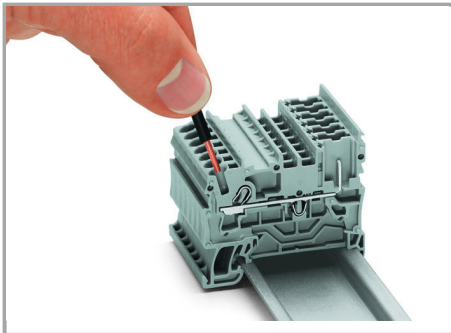

Push-in CAGE CLAMP® enables solid conductors and fine-stranded conductors with ferrules to be connected by simply pushing them into the unit.

Commoning

Supus modificărilor.

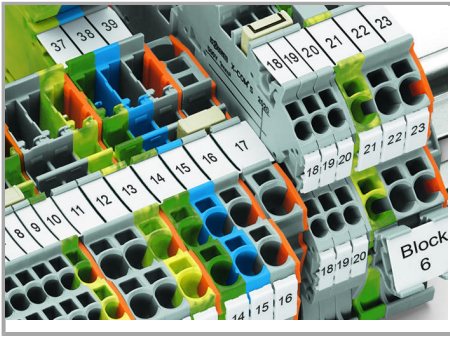

Commoning X-COM®S-SYSTEM Terminal Blocks using jumpers for TOPJOB® S Terminal Blocks. An end plate provides connection to TOPJOB® S Terminal Blocks. 2020 and 2022 Series Terminal Blocks are combinable. Jumper slots are on the same level for both series.

Testing

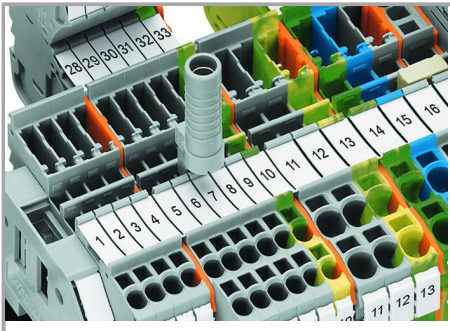

Test plug adapter (2009-174) for 4 mm test plugs or banana plugs – also suitable for X-COM®S-SYSTEM-MINI Terminal Blocks.

Coding

Supus modificărilor.

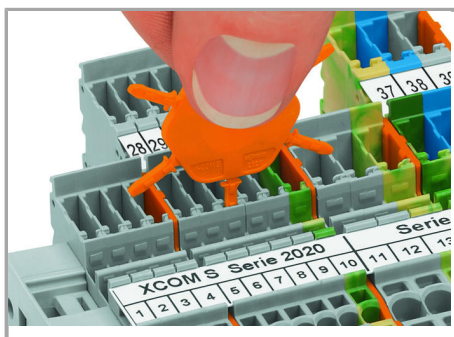

Insert coding pin into the corresponding slot and twist it off.

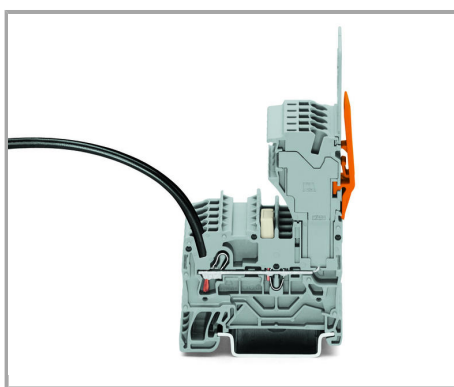

1-conductor female plug

Carrier terminal blocks can be commoned via 2000 Series Push-In Type Jumper Bars and tested via 859-500 Test Pin.

Marking

Supus modificărilor.

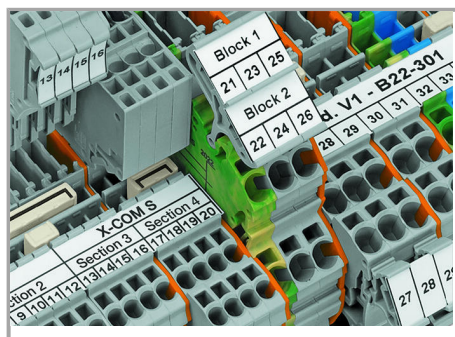

Clear marking via large marking area

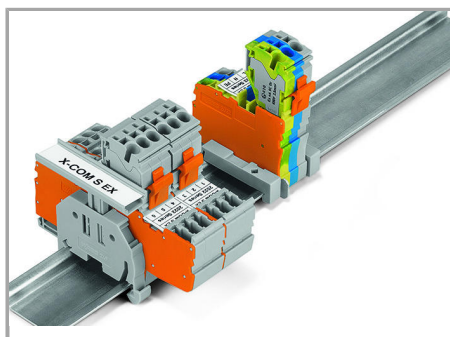

Group marking with height-adjustable group marker carrier (2009 163)

Safety

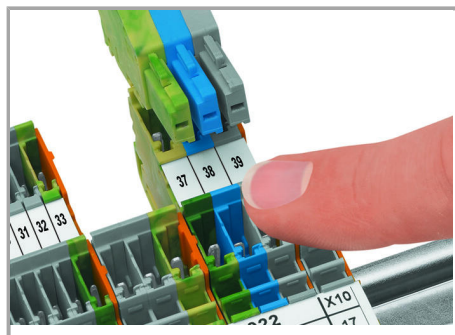

Carrier terminal blocks and female plugs are touch-proof.

Familie de produse

X-COM S

Afișare globală produse din familie.

Supus modificărilor.