

Fișă tehnică | Număr articol: 282-687

3-conductor ground terminal block; 6 mm²; center marking; for DIN-rail 35 x 15 and 35 x 7.5; CAGE CLAMP®; 6,00 mm²; green-yellow

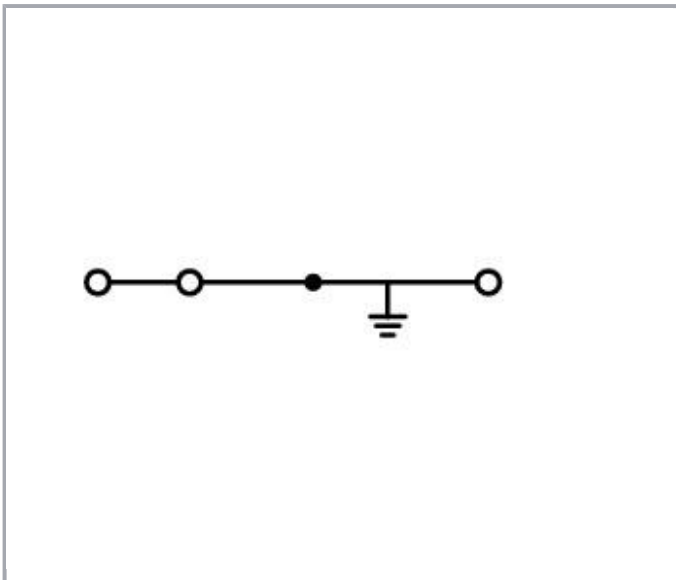

www.wago.com/282-687

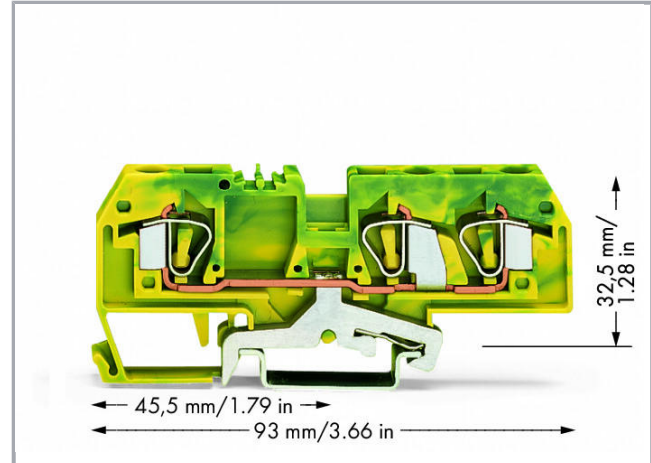

Date

Electrical data

Ratings per IEC/EN 60664-1

Ratings per

IEC/EN 60947-7-2

Supus modificărilor.

WAGO Kontakttechnik GmbH & Co. KG
/Representative Office Romania
Sos. Pipera-Tunari nr. 1/1
building 1, 2nd floor | 077190 Voluntari, Ilfov
Tel.: +40-(0)31 421 85 68 | Email: info-RO@wago.com

Aveți întrebări despre produsele noastre?
Vă stăm la dispoziție pentru preluarea apelului la +40 (0) 31 421 85 68.



Connection data

Connection technology	CAGE CLAMP®
Actuation type	Operating tool
Connectable conductor materials	Copper
Solid conductor	0,2 ... 6 mm ² / 24 ... 10 AWG
Fine-stranded conductor	0,2 ... 6 mm ² / 24 ... 10 AWG
Strip length	12 ... 13 mm / 0.47 ... 0.51 inch
Total number of connection points	3
Total number of potentials	1
Number of levels	1
Wiring type	Front-entry wiring

Geometrical Data

Width	8 mm / 0.315 inch
Height from upper-edge of DIN-rail	32,5 mm / 1.28 inch
Depth	93 mm / 3.661 inch

Mechanical data

Design	horizontal type
Mounting type	DIN-35 rail
Marking level	Center marking

Material Data

Color	green-yellow
Insulation material	Polyamide 66 (PA 66)
Fire load	0,312 MJ
Weight	27,6 g

Commercial data

Product Group	1 (Rail Mounted Terminal Blocks)
Packaging type	BOX
Country of origin	DE
GTIN	4044918471749
Customs tariff number	85369010000



Supus modificărilor.

WAGO Kontakttechnik GmbH & Co. KG
 /Representative Office Romania
 Sos. Pipera-Tunari nr. 1/1
 building 1, 2nd floor | 077190 Voluntari, Ilfov
 Tel.: +40-(0)31 421 85 68 | Email: info-RO@wago.com



Aveți întrebări despre produsele noastre?
 Vă stăm la dispoziție pentru preluarea apelului la +40 (0) 31 421 85 68.

Aprobări / certificate

Country specific Approvals

Emblemă	Aprobare	Text de aprobare suplimentar	Nume certificat
	CCA DEKRA Certification B.V.	EN 60947	NTR NL-7522
	CCA DEKRA Certification B.V.	EN 60947	2195540.01
	CSA DEKRA Certification B.V.	C22.2 No. 158	1505033

Ship Approvals

Emblemă	Aprobare	Text de aprobare suplimentar	Nume certificat
	ABS American Bureau of Shipping	EN 60947	20-HG1941090-PDA
	BV Bureau Veritas S.A.	EN 60947	07436/E0 BV
	DNV GL Det Norske Veritas, Germanischer Lloyd	-	TAE00001V2
	LR Lloyds Register	EN 60947	91/20112 (E9)

UL-Approvals









Emblemă	Aprobare	Text de aprobare suplimentar	Nume certificat
	UL UL International Germany GmbH	UL 1059	20190731-E45172

Supus modificărilor.

Counterpart

Produse compatibile















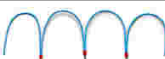

Carrier rail

	Nr. articol: 210-112 Steel carrier rail; 35 x 7.5 mm; 1 mm thick; 2 m long; slotted; according to EN 60715; "Hole width 25 mm	www.wago.com/210-112
	Nr. articol: 210-113 Steel carrier rail; 35 x 7.5 mm; 1 mm thick; 2 m long; unslotted; according to EN 60715	www.wago.com/210-113
	Nr. articol: 210-114 Steel carrier rail; 35 x 15 mm; 1.5 mm thick; 2 m long; unslotted; similar to EN 60715	www.wago.com/210-114
	Nr. articol: 210-115 Steel carrier rail; 35 x 7.5 mm; 1 mm thick; 2 m long; slotted; according to EN 60715; "Hole width 18 mm	www.wago.com/210-115
	Nr. articol: 210-118 Steel carrier rail; 35 x 15 mm; 2.3 mm thick; 2 m long; unslotted; according to EN 60715	www.wago.com/210-118
	Nr. articol: 210-196 Aluminum carrier rail; 35 x 8.2 mm; 1.6 mm thick; 2 m long; unslotted; similar to EN 60715; silver-colored	www.wago.com/210-196
	Nr. articol: 210-197 Steel carrier rail; 35 x 15 mm; 1.5 mm thick; 2 m long; slotted; similar to EN 60715	www.wago.com/210-197
	Nr. articol: 210-198 Copper carrier rail; 35 x 15 mm; 2.3 mm thick; 2 m long; unslotted; according to EN 60715; copper-colored	www.wago.com/210-198
	Nr. articol: 210-504 Steel carrier rail; 35 x 7.5 mm; 1 mm thick; 2 m long; slotted; galvanized; according to EN 60715	www.wago.com/210-504
	Nr. articol: 210-505 Steel carrier rail; 35 x 7.5 mm; 1 mm thick; 2 m long; unslotted; galvanized; according to EN 60715	www.wago.com/210-505
	Nr. articol: 210-506 Steel carrier rail; 35 x 15 mm; 1.5 mm thick; 2 m long; unslotted; galvanized; similar to EN 60715	www.wago.com/210-506

Supus modificărilor.

WAGO Kontakttechnik GmbH & Co. KG
/Representative Office Romania
Sos. Pipera-Tunari nr. 1/1
building 1, 2nd floor | 077190 Voluntari, Ilfov
Tel.: +40-(0)31 421 85 68 | Email: info-RO@wago.com

Aveți întrebări despre produsele noastre?
Vă stăm la dispoziție pentru preluarea apelului la +40 (0) 31 421 85 68.

	Nr. articol: 210-508 Steel carrier rail; 35 x 15 mm; 1.5 mm thick; 2 m long; slotted; galvanized; similar to EN 60715	www.wago.com/210-508
General accessories		
	Nr. articol: 209-143 Group marker carrier; gray	www.wago.com/209-143
	Nr. articol: 209-144 Group marker carrier; gray	www.wago.com/209-144
	Nr. articol: 709-310 B-type test plug module; modular; suitable for all WAGO 282 Series rail-mounted terminal blocks with jumper slots; 6,00 mm ² ; gray	www.wago.com/709-310
	Nr. articol: 709-311 B-type spacer module; modular; e.g., for bridging commoned terminal blocks; gray	www.wago.com/709-311
Jumper		
	Nr. articol: 210-103 Wire commoning chain; insulated; 50 connections; black	www.wago.com/210-103
	Nr. articol: 210-123 Wire commoning chain; insulated; 50 connections	www.wago.com/210-123
	Nr. articol: 282-402 Adjacent jumper; insulated; Nominal current 41 A	www.wago.com/282-402
	Nr. articol: 282-409 Alternate jumper; insulated; Nominal current 41 A; gray	www.wago.com/282-409
	Nr. articol: 282-422 Adjacent jumper; insulated; Nominal current 41 A; yellow-green	www.wago.com/282-422
	Nr. articol: 282-424 Adjacent jumper; insulated; Nominal current 41 A; orange	www.wago.com/282-424
	Nr. articol: 709-110 Wire commoning chain; insulated; 4 connections; 3 x 110 mm; black	www.wago.com/709-110
	Nr. articol: 709-111 Wire commoning chain; insulated; 3 connections; 2 x 120 mm; black	www.wago.com/709-111
	Nr. articol: 709-112 Wire commoning chain; insulated; 3 connections; 2 x 170 mm; black	www.wago.com/709-112
tools		
	Nr. articol: 210-721 Operating tool; Blade: 5.5 x 0.8 mm; with a partially insulated shaft	www.wago.com/210-721
assembling		
	Nr. articol: 209-106 Mounting carrier; for isolated mounting on DIN 35 rails; gray	www.wago.com/209-106

Supus modificărilor.

**Nr. articol: 709-153**

Cover; Type 1; suitable for cover carrier, type 1; 1 m long; transparent

www.wago.com/709-153**protection****Nr. articol: 282-415**

Protective warning marker; with high-voltage symbol, black; for 5 terminal blocks; yellow

www.wago.com/282-415**End plate****Nr. articol: 282-308**

End and intermediate plate; 2.5 mm thick; gray

www.wago.com/282-308**Nr. articol: 282-309**

Separator plate; 2 mm thick; oversized; gray

www.wago.com/282-309**Nr. articol: 282-339**

End and intermediate plate; 2.5 mm thick; orange

www.wago.com/282-339**Nr. articol: 282-340**

Separator plate; 2 mm thick; oversized; orange

www.wago.com/282-340**Marking accessories****Nr. articol: 2009-115**

WMB-Inline; for Smart Printer; 1500 pieces on roll; stretchable 5 - 5.2 mm; plain; snap-on type; white

www.wago.com/2009-115**Nr. articol: 2009-115/000-002**

WMB-Inline; for Smart Printer; 1500 pieces on roll; stretchable 5 - 5.2 mm; plain; snap-on type; yellow

www.wago.com/2009-115/000-002**Nr. articol: 2009-115/000-006**

WMB-Inline; for Smart Printer; 1500 pieces on roll; stretchable 5 - 5.2 mm; plain; snap-on type; blue

www.wago.com/2009-115/000-006**Nr. articol: 2009-115/000-007**

WMB-Inline; for Smart Printer; 1500 pieces on roll; stretchable 5 - 5.2 mm; plain; snap-on type; gray

www.wago.com/2009-115/000-007**Nr. articol: 2009-115/000-012**

WMB-Inline; for Smart Printer; 1500 pieces on roll; stretchable 5 - 5.2 mm; plain; snap-on type; orange

www.wago.com/2009-115/000-012**Nr. articol: 2009-115/000-017**

WMB-Inline; for Smart Printer; 1500 pieces on roll; stretchable 5 - 5.2 mm; plain; snap-on type; light green

www.wago.com/2009-115/000-017**Nr. articol: 2009-115/000-023**















WMB-Inline; for Smart Printer; 1500 pieces on roll; stretchable 5 - 5.2 mm; plain; snap-on type; green

www.wago.com/2009-115/000-023**Nr. articol: 2009-115/000-024**

WMB-Inline; for Smart Printer; 1500 pieces on roll; stretchable 5 - 5.2 mm; plain; snap-on type; violet

www.wago.com/2009-115/000-024**Nr. articol: 209-185**

Supus modificărilor.

	Adaptor; gray	www.wago.com/209-185
	Nr. articol: 210-612 Marking strips; for self-marking; plain; Self-adhesive; transparent	www.wago.com/210-612
	Nr. articol: 249-105 Group marker carrier; gray	www.wago.com/249-105
	Nr. articol: 793-501 WMB marking card; as card; not stretchable; plain; snap-on type; white	www.wago.com/793-501
	Nr. articol: 793-501/000-002 WMB marking card; as card; not stretchable; plain; snap-on type; yellow	www.wago.com/793-501/000-002
	Nr. articol: 793-501/000-005 WMB marking card; as card; not stretchable; plain; snap-on type; red	www.wago.com/793-501/000-005
	Nr. articol: 793-501/000-006 WMB marking card; as card; not stretchable; plain; snap-on type; blue	www.wago.com/793-501/000-006
	Nr. articol: 793-501/000-007 WMB marking card; as card; not stretchable; plain; snap-on type; gray	www.wago.com/793-501/000-007
	Nr. articol: 793-501/000-012 WMB marking card; as card; not stretchable; plain; snap-on type; orange	www.wago.com/793-501/000-012
	Nr. articol: 793-501/000-017 WMB marking card; as card; not stretchable; plain; snap-on type; light green	www.wago.com/793-501/000-017
	Nr. articol: 793-501/000-023 WMB marking card; as card; not stretchable; plain; snap-on type; green	www.wago.com/793-501/000-023
	Nr. articol: 793-501/000-024 WMB marking card; as card; not stretchable; plain; snap-on type; violet	www.wago.com/793-501/000-024
	Nr. articol: 793-5501 WMB marking card; as card; for terminal block width 5 - 17.5 mm; stretchable 5 - 5.2 mm; plain; snap-on type; white	www.wago.com/793-5501
	Nr. articol: 793-5501/000-002 WMB marking card; as card; for terminal block width 5 - 17.5 mm; stretchable 5 - 5.2 mm; plain; snap-on type; yellow	www.wago.com/793-5501/000-002
	Nr. articol: 793-5501/000-005 WMB marking card; as card; for terminal block width 5 - 17.5 mm; stretchable 5 - 5.2 mm; plain; snap-	

Supus modificărilor.



on type; red

www.wago.com/793-5501/000-005**Nr. articol: 793-5501/000-006**

WMB marking card; as card; for terminal block width 5 - 17.5 mm; stretchable 5 - 5.2 mm; plain; snap-on type; blue

www.wago.com/793-5501/000-006**Nr. articol: 793-5501/000-007**

WMB marking card; as card; for terminal block width 5 - 17.5 mm; stretchable 5 - 5.2 mm; plain; snap-on type; gray

www.wago.com/793-5501/000-007**Nr. articol: 793-5501/000-012**

WMB marking card; as card; for terminal block width 5 - 17.5 mm; stretchable 5 - 5.2 mm; plain; snap-on type; orange

www.wago.com/793-5501/000-012**Nr. articol: 793-5501/000-014**

WMB marking card; as card; for terminal block width 5 - 17.5 mm; stretchable 5 - 5.2 mm; plain; snap-on type; brown

www.wago.com/793-5501/000-014**Nr. articol: 793-5501/000-017**

WMB marking card; as card; for terminal block width 5 - 17.5 mm; stretchable 5 - 5.2 mm; plain; snap-on type; green

www.wago.com/793-5501/000-017**Nr. articol: 793-5501/000-023**

WMB marking card; as card; for terminal block width 5 - 17.5 mm; stretchable 5 - 5.2 mm; plain; snap-on type; light green

www.wago.com/793-5501/000-023**Nr. articol: 793-5501/000-024**

WMB marking card; as card; for terminal block width 5 - 17.5 mm; stretchable 5 - 5.2 mm; plain; snap-on type; violet

www.wago.com/793-5501/000-024**check****Nr. articol: 209-170**Test plug adapter; 8.3 mm wide; for 4 mm Ø test plugs; suitable for 1.5 mm² - 10 mm² tbs; graywww.wago.com/209-170**ferrule****Nr. articol: 216-262**Ferrule; Sleeve for 0.75 mm² / 18 AWG; insulated; electro-tin plated; electrolytic copper; gastight crimped; acc. to DIN 46228, Part 4/09.90; graywww.wago.com/216-262**Nr. articol: 216-263**Ferrule; Sleeve for 1 mm² / AWG 18; insulated; electro-tin plated; electrolytic copper; gastight crimped; acc. to DIN 46228, Part 4/09.90; redwww.wago.com/216-263**Nr. articol: 216-264**Ferrule; Sleeve for 1.5 mm² / AWG 16; insulated; electro-tin plated; electrolytic copper; gastight crimped; acc. to DIN 46228, Part 4/09.90; blackwww.wago.com/216-264**Nr. articol: 216-266**Ferrule; Sleeve for 2.5 mm² / AWG 14; insulated; electro-tin plated; electrolytic copper; gastight crimped; acc. to DIN 46228, Part 4/09.90; bluewww.wago.com/216-266**Nr. articol: 216-267**Ferrule; Sleeve for 4 mm² / AWG 12; insulated; electro-tin plated; electrolytic copper; gastightwww.wago.com/216-267

Supus modificărilor.



crimped; acc. to DIN 46228, Part 4/09.90; gray

Descărcări Documentation

Additional Information

Technical explanations

Apr 3, 2019

pdf
2,1 MB

Descărcare

CAD/CAE-Data

CAD data

2D/3D Models 282-687

URL

Descărcare

CAE data

EPLAN Data Portal 282-687

URL

Descărcare

WSCAD Universe 282-687

URL

Descărcare

Installation Notes

Installation

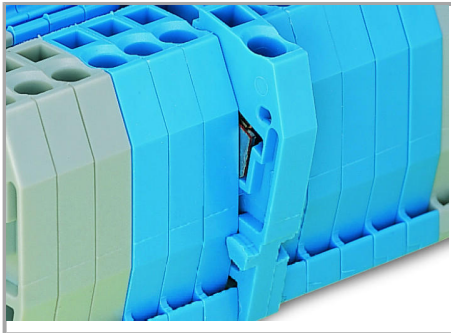

Quick assembly keys prevent reverse mounting.

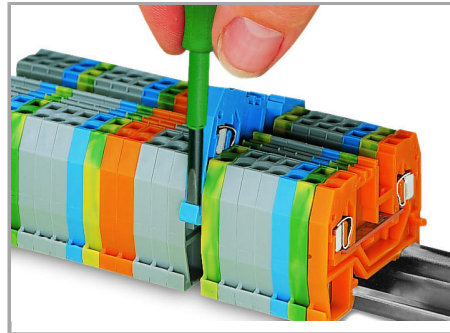

Removing a terminal block from the assembly.

Inserting a conductor

Supus modificărilor.

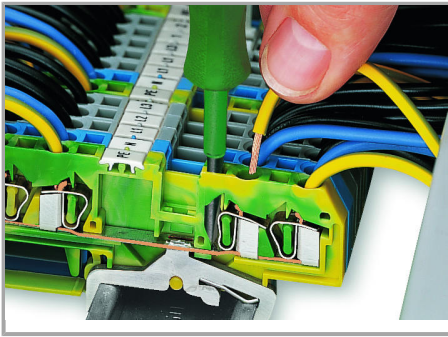

CAGE CLAMP® connection

Inserting a conductor.

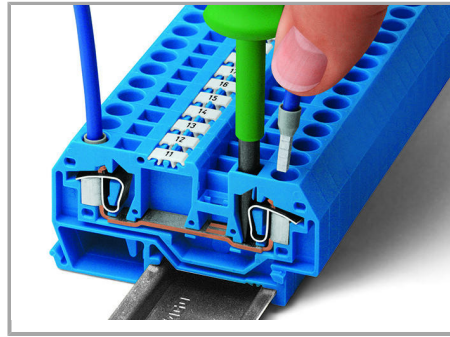

CAGE CLAMP® connection

Inserting a conductor.

With ferruled conductors, it is necessary to use a terminal block one size larger than the conductor's nominal cross-section.

Testing

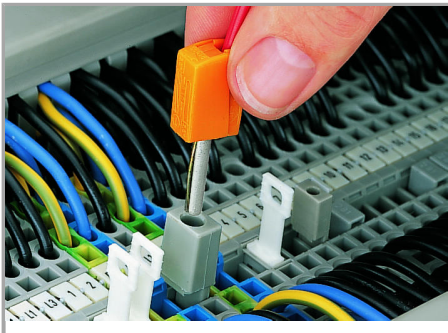

Testing with a test plug

(picture shows 209-170 Test Plug Adapter).

Marking

Supus modificărilor.

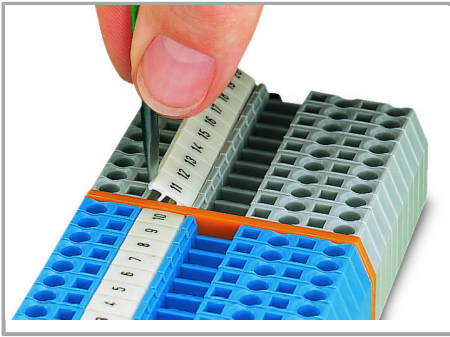

Marking via WMB Multi Marking System.

Supus modificărilor.