

Descriere articol

- Protected against mismatching and maintenance-free
- Push-in CAGE CLAMP® spring pressure connection technology allows solid conductors to be simply pushed into a unit
- Compact design with 4.4 mm pole spacing
- When assembled, the installation connectors complies with IP40 and are suitable for easily accessible areas

Note:

All connectors for mounted installations (snap-in versions for lighting fixtures or devices, all types of PCB and distribution connectors) are factory-equipped with locking levers to ensure plugs and sockets are securely locked. Additional locking levers are only required for flying leads (plug /socket).

Note on mismatching protection:

All WINSTA® components are 100% protected against mismatching when:

- a.) plugging different numbers of poles
- b.) plugging while rotated 180
- c.) plugging while laterally staggered
- d.) plugging one pole

Safety information 1:

Application note for the U.S. market (USR): Some versions may also be used for current interruption in accordance with the UL certificate in select applications with currents below 5 A and voltages up to 600 V. For further information, please contact your local sales office.

Supus modificărilor.

**Date****Electrical data**

Note on Contact Resistance

approx. 1 mΩ of contact resistance approx. 0.25 mΩ contact transition plug/socket

Ratings per IEC/EN 60664-1

Ratings per	IEC/EN 60664-1
Nominal voltage (III/3)	250 V
Rated surge voltage (III/3)	4 kV
Rated current	16 A
Legend (ratings)	(III / 3) ≙ Overvoltage category III / Pollution degree 3

Approvals per UL 1977

Rated voltage UL 1977	600 V
Rated current UL 1977	14 A

Connection data

Connection technology	Push-in CAGE CLAMP®
Actuation type	Operating tool Push-in
Nominal cross-section	1,5 mm ²
Solid conductor	0,25 ... 1,5 mm ² / 22 ... 16 AWG
Solid conductor; push-in termination	0,75 ... 1,5 mm ² / 20 ... 16 AWG
Stranded conductor	0,25 ... 1 mm ² / 22 ... 18 AWG
Fine-stranded conductor	0,25 ... 1,5 mm ² / 22 ... 16 AWG
Fine-stranded conductor; with insulated ferrule	0,25 ... 0,75 mm ² / 22 ... 20 AWG
Fine-stranded conductor; with uninsulated ferrule	0,25 ... 0,75 mm ² / 22 ... 20 AWG
Fine-stranded conductor; with ferrule; push-in termination	0,75 mm ² / 20 AWG
Strip length	9 mm / 0.35 inch
Note (strip length)	see also packaging or instructions
Pole No.	2
Total number of connection points	2
Total number of potentials	2
Conductor entry direction to mating direction	0°

Supus modificărilor.

WAGO Kontakttechnik GmbH & Co. KG
 /Representative Office Romania
 Sos. Pipera-Tunari nr. 1/1
 building 1, 2nd floor | 077190 Voluntari, Ilfov
 Tel.: +40-(0)31 421 85 68 | Email: info-RO@wago.com

Aveți întrebări despre produsele noastre?
 Vă stăm la dispoziție pentru preluarea apelului la +40 (0) 31 421 85 68.



Geometrical Data

Pin spacing	4,4 mm / 0.173 inch
Width	10,4 mm / 0.409 inch
Height	11,7 mm / 0.461 inch
Depth	34,1 mm / 1.343 inch

Mechanical data

Technologie	DALI
Coding	I
Mating force of a plug-in connection	approx. 20 ... 70 N (depending on pole number)
Retention force of a plug-in connection	Locked: > 80 N
Unmating force of a plug-in connection	Unlocked: approx. 20 ... 70 N (depending on pole number)
Number of mating cycles	200, without resistive load 100, with resistive load $I_N = 16$ A, tested (1.5 mm ² /AWG 16)
Marking	+ -
Protection type	IP20
Note on protection type	IP40 when mated with strain relief housing
Potential marking	+ -
Application	Lighting management

Plug connection

Contact type (pluggable connector)	Male connector/plug
Connector (connection type)	for conductor
Mismating protection	Yes
Locking of plug-in connection	locking lever
Locking lever	retrofitable

Material Data

Color	blue
Insulation material	Polyamide 66 (PA 66)
Clamping spring material	Chrome nickel spring steel (CrNi)
Contact material	Copper or copper alloy (surface-treated)
Fire load	0,056 MJ

Supus modificărilor.

WAGO Kontakttechnik GmbH & Co. KG
/Representative Office Romania
Sos. Pipera-Tunari nr. 1/1
building 1, 2nd floor | 077190 Voluntari, Ilfov
Tel.: +40-(0)31 421 85 68 | Email: info-RO@wago.com

Aveți întrebări despre produsele noastre?
Vă stăm la dispoziție pentru preluarea apelului la +40 (0) 31 421 85 68.

Weight	2,5g
--------	------

Environmental Requirements

Processing temperature	-5 ... +40 °C
Continuous operating temperature	-35 ... +85 °C
Note on continuous operating temperature	Insulating parts for temperatures ≤ 105 °C

Commercial data

Product Group	20 (WINSTA)
Packaging type	BOX
Country of origin	PL
GTIN	4055143548502
Customs tariff number	85366990990

Aprobări / certificate

Country specific Approvals

Emblemă	Aprobare	Text de aprobare suplimentar	Nume certificat
	CCA DEKRA Certification B.V.	EN 61535	71- 102984

Ship Approvals

Emblemă	Aprobare	Text de aprobare suplimentar	Nume certificat
	ABS American Bureau of Shipping	Steel Vessel Rules	19- HG1869855- PDA
	DNV GL Det Norske Veritas, Germanischer Lloyd	-	TAE00001Z6
	LR Lloyds Register	EN 61535	08/20047 (E2)

UL-Approvals

Supus modificărilor.

WAGO Kontakttechnik GmbH & Co. KG
/Representative Office Romania
Sos. Pipera-Tunari nr. 1/1
building 1, 2nd floor | 077190 Voluntari, Ilfov
Tel.: +40-(0)31 421 85 68 | Email: info-RO@wago.com

Aveți întrebări despre produsele noastre?
Vă stăm la dispoziție pentru preluarea apelului la +40 (0) 31 421 85 68.

Emblemă	Aprobare	Text de aprobare suplimentar	Nume certificat
	cURus Underwriters Laboratories Inc.	UL 1977	E45171

Counterpart



Nr. articol890-1102
Socket; 2-pole; Cod. I; 1,50 mm²; blue

www.wago.com/890-1102



Nr. articol890-1617
T-distribution connector; 2-pole; Cod. I; 1 input; 2 outputs; 2 locking levers; blue

www.wago.com/890-1617



Nr. articol890-1620
T-distribution connector; 2-pole; Cod. I; 1 input; 2 outputs; 3 locking levers; for flying leads; blue

www.wago.com/890-1620



Nr. articol890-1904
3-way distribution connector; 2-pole; Cod. I; 1 input; 3 outputs; blue

www.wago.com/890-1904



Nr. articol890-1907
5-way distribution connector; 2-pole; Cod. I; 1 input; 5 outputs; blue

www.wago.com/890-1907



Nr. articol890-2102
Snap-in socket; 2-pole; Cod. I; 1,50 mm²; blue

www.wago.com/890-2102



Nr. articol890-3102
Socket for PCBs; straight; 2-pole; Cod. I

www.wago.com/890-3102



Nr. articol890-3102/011-000
Socket for PCBs; angled; 2-pole; Cod. I

www.wago.com/890-3102/011-000



Nr. articol891-8982/006-101

www.wago.com/891-8982

Supus modificărilor.

pre-assembled interconnecting cable; Eca; Socket/plug; 2-pole; Cod. I; H05VV-F 2 x 1.5 mm²; 1 m; /006-101
1,50 mm²; blue



Nr. articol891-8982/106-101

pre-assembled connecting cable; Eca; Socket/open-ended; 2-pole; Cod. I; H05VV-F 2 x 1.5 mm²; 1 m; 1,50 mm²; blue

www.wago.com/891-8982/106-101

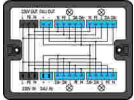

Nr. articol899-631/181-000

Distribution box; 230 V + DALI; 2 inputs; 6 outputs; Cod. A, I; MINI, MIDI; black

www.wago.com/899-631/181-000

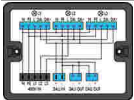

Nr. articol899-631/455-000

Distribution box; 400 V + DALI; 2 inputs; 5 outputs; Cod. A, I; MINI, MIDI; black

www.wago.com/899-631/455-000

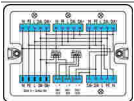

Nr. articol899-681/146-000

Distribution box; 230 V + DALI; 1 input; 7 outputs; Cod. A, B, I; MINI, MIDI; white

www.wago.com/899-681/146-000

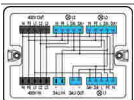

Nr. articol899-681/147-000

Distribution box; 400 V + DALI; 2 inputs; 5 outputs; Cod. A, I; MINI, MIDI; white

www.wago.com/899-681/147-000

Produse compatibile

tools



Nr. articol: 210-719

Operating tool; Blade: 2.5 x 0.4 mm; with a partially insulated shaft

www.wago.com/210-719

Descărcări

CAD/CAE-Data

CAD data

2D/3D Models 890-1112

[URL](#)

[Descărcare](#)

CAE data

EPLAN Data Portal 890-1112

[URL](#)

[Descărcare](#)

WSCAD Universe 890-1112

[URL](#)

[Descărcare](#)

Installation Notes

Supus modificărilor.

WAGO Kontakttechnik GmbH & Co. KG
/Representative Office Romania
Sos. Pipera-Tunari nr. 1/1
building 1, 2nd floor | 077190 Voluntari, Ilfov
Tel.: +40-(0)31 421 85 68 | Email: info-RO@wago.com

Aveți întrebări despre produsele noastre?

Vă stăm la dispoziție pentru preluarea apelului la +40 (0) 31 421 85 68.

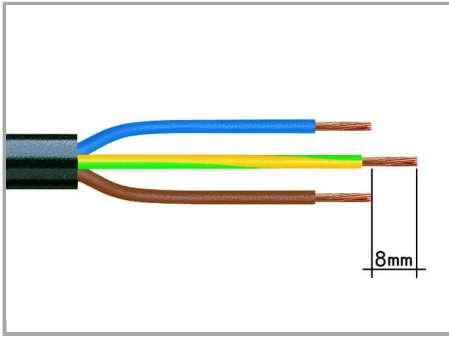

1. Strip length, outer insulation = 30 mm (2-pole), 37 mm (3-pole), 45 mm (4- and 5-pole)

2. Strip length = 9 mm

3. Extended ground conductor = 8 mm

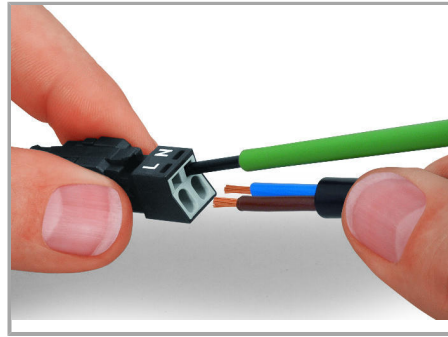

To terminate fine-stranded conductors, open the clamping unit via screwdriver (2.5 mm blade width) and insert a stripped conductor until it hits backstop. Terminate solid conductors by simply pushing them in.

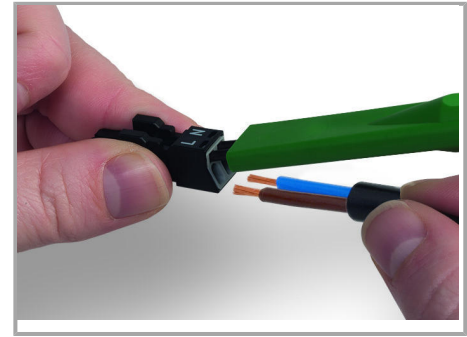

To terminate fine-stranded conductors, open clamping units via operating tool (890-382) and insert stripped conductors until they hit backstop.

Terminate solid conductors by simply pushing them in.

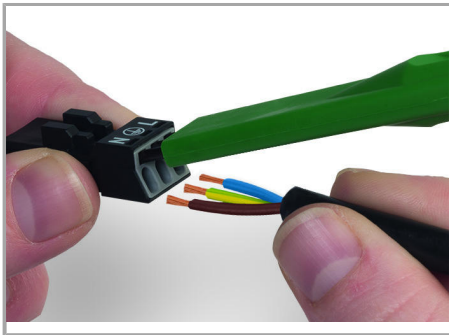

To terminate fine-stranded conductors, open clamping units via operating tool (890-383) and insert stripped conductors until they hit backstop.

Terminate solid conductors by simply pushing them in.

Installation

Supus modificărilor.



Latch wired connector onto the base of the strain relief housing.



Push down strain relief clamp by hand.

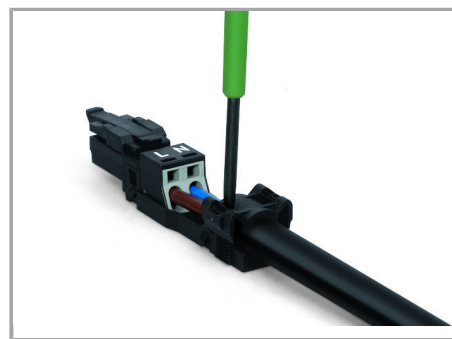

Push down strain relief clamp via 2.5 mm screwdriver alternately on both sides.

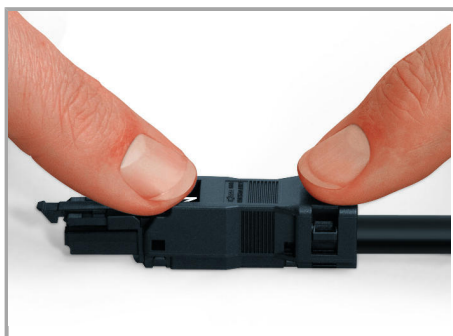

Latch the top of the strain relief housing.

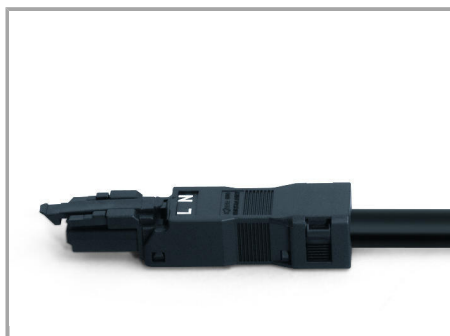

The printed marking of the connector is clearly visible in the openings of the strain relief housing.

Familie de produse

WINSTA® MINI

Afișare globală produse din familie.

Supus modificărilor.