

Fișă tehnică | Număr articol: 279-837

4-conductor ground terminal block; 1.5 mm²; center marking; for DIN-rail 35 x 15 and 35 x 7.5; CAGE CLAMP®; 1,50 mm²; green-yellow

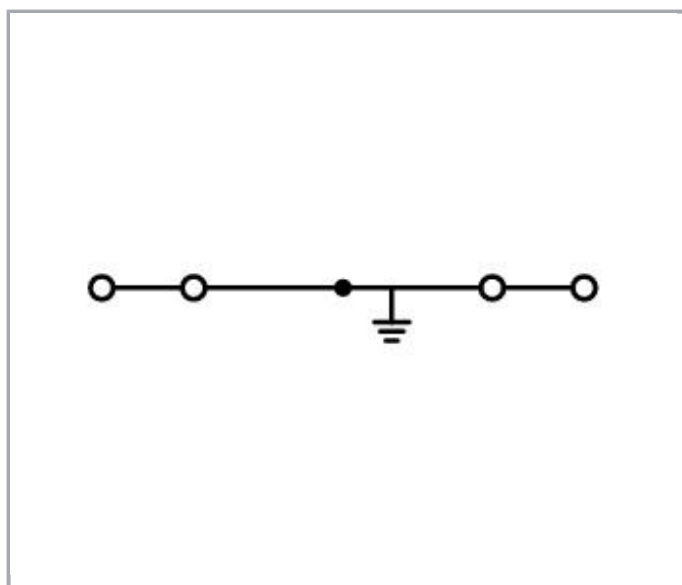

www.wago.com/279-837

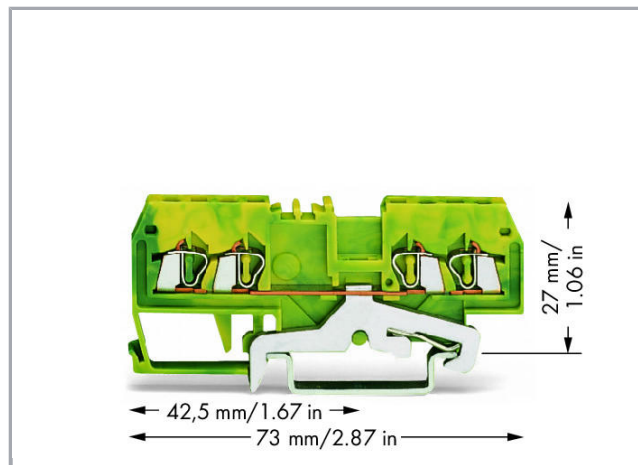
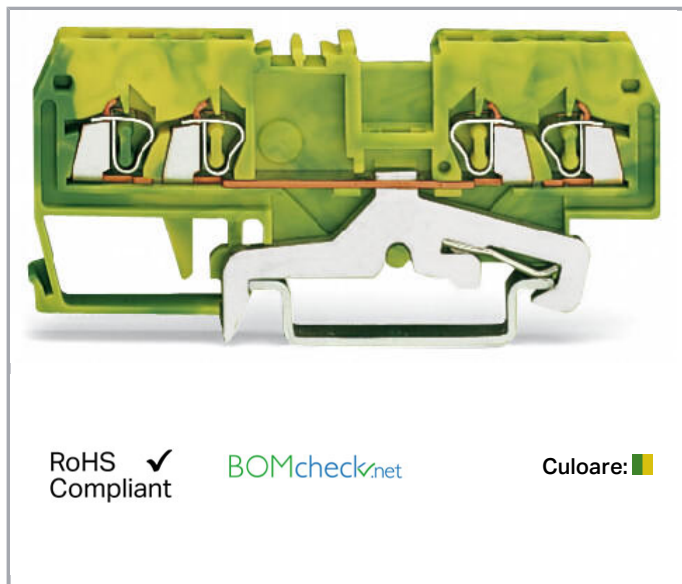

Date

Electrical data

Supus modificărilor.

WAGO Kontakttechnik GmbH & Co. KG
/Representative Office Romania
Sos. Pipera-Tunari nr. 1/1
building 1, 2nd floor | 077190 Voluntari, Ilfov
Tel.: +40-(0)31 421 85 68 | Email: info-RO@wago.com

Aveți întrebări despre produsele noastre?
Vă stăm la dispoziție pentru preluarea apelului la +40 (0) 31 421 85 68.

Ratings per IEC/EN 60664-1

Ratings per	IEC/EN 60947-7-2
-------------	------------------

Connection data

Connection technology	CAGE CLAMP®
Actuation type	Operating tool
Connectable conductor materials	Copper
Solid conductor	0,08 ... 1,5 mm ² / 28 ... 16 AWG
Fine-stranded conductor	0,08 ... 1,5 mm ² / 28 ... 16 AWG
Strip length	8 ... 9 mm / 0.31 ... 0.35 inch
Total number of connection points	4
Total number of potentials	1
Number of levels	1
Wiring type	Front-entry wiring

Geometrical Data

Width	4 mm / 0.157 inch
Height from upper-edge of DIN-rail	27 mm / 1.063 inch
Depth	73 mm / 2.874 inch

Mechanical data

Design	horizontal type
Mounting type	DIN-35 rail
Marking level	Center marking

Material Data

Color	green-yellow
Insulation material	Polyamide 66 (PA 66)
Fire load	0,103 MJ
Weight	9,9 g

Commercial data

Product Group	1 (Rail Mounted Terminal Blocks)
Packaging type	BOX

Supus modificărilor.



WAGO Kontakttechnik GmbH & Co. KG
 /Representative Office Romania
 Sos. Pipera-Tunari nr. 1/1
 building 1, 2nd floor | 077190 Voluntari, Ilfov
 Tel.: +40-(0)31 421 85 68 | Email: info-RO@wago.com

Aveți întrebări despre produsele noastre?
 Vă stăm la dispoziție pentru preluarea apelului la +40 (0) 31 421 85 68.





Country of origin	DE
GTIN	4045454084455
Customs tariff number	85369010000

Aprobări / certificate

Country specific Approvals

Emblemă	Aprobare	Text de aprobare suplimentar	Nume certificat
	CCA DEKRA Certification B.V.	EN 60947	NTR NL-7081
	CSA DEKRA Certification B.V.	C22.2 No. 158	70133738
	KEMA/KEUR DEKRA Certification B.V.	EN 60947	2160584.04

Ship Approvals

Emblemă	Aprobare	Text de aprobare suplimentar	Nume certificat
	ABS American Bureau of Shipping	-	20-HG1941090-PDA
	BV Bureau Veritas S.A.	EN 60947	07436/E0 BV
	DNV GL Det Norske Veritas, Germanischer Lloyd	-	TAE00001V2
	LR Lloyds Register	EN 60947	91/20112 (E9)

UL-Approvals

Nume

Supus modificărilor.

WAGO Kontakttechnik GmbH & Co. KG
/Representative Office Romania
Sos. Pipera-Tunari nr. 1/1
building 1, 2nd floor | 077190 Voluntari, Ilfov
Tel.: +40-(0)31 421 85 68 | Email: info-RO@wago.com









Aveți întrebări despre produsele noastre?
Vă stăm la dispoziție pentru preluarea apelului la +40 (0) 31 421 85 68.

Emblemă	Aprobare	Text de aprobare suplimentar	certificat
	UR Underwriters Laboratories Inc.	UL 1059	E45172

Counterpart

Produse compatibile







Carrier rail

	Nr. articol: 210-112 Steel carrier rail; 35 x 7.5 mm; 1 mm thick; 2 m long; slotted; according to EN 60715; "Hole width 25 mm	www.wago.com/210-112
	Nr. articol: 210-113 Steel carrier rail; 35 x 7.5 mm; 1 mm thick; 2 m long; unslotted; according to EN 60715	www.wago.com/210-113
	Nr. articol: 210-114 Steel carrier rail; 35 x 15 mm; 1.5 mm thick; 2 m long; unslotted; similar to EN 60715	www.wago.com/210-114
	Nr. articol: 210-115 Steel carrier rail; 35 x 7.5 mm; 1 mm thick; 2 m long; slotted; according to EN 60715; "Hole width 18 mm	www.wago.com/210-115
	Nr. articol: 210-118 Steel carrier rail; 35 x 15 mm; 2.3 mm thick; 2 m long; unslotted; according to EN 60715	www.wago.com/210-118
	Nr. articol: 210-196 Aluminum carrier rail; 35 x 8.2 mm; 1.6 mm thick; 2 m long; unslotted; similar to EN 60715; silver-colored	www.wago.com/210-196
	Nr. articol: 210-197 Steel carrier rail; 35 x 15 mm; 1.5 mm thick; 2 m long; slotted; similar to EN 60715	www.wago.com/210-197
	Nr. articol: 210-198 Copper carrier rail; 35 x 15 mm; 2.3 mm thick; 2 m long; unslotted; according to EN 60715; copper-colored	www.wago.com/210-198
	Nr. articol: 210-504 Steel carrier rail; 35 x 7.5 mm; 1 mm thick; 2 m long; slotted; galvanized; according to EN 60715	www.wago.com/210-504















Supus modificărilor.

WAGO Kontakttechnik GmbH & Co. KG
/Representative Office Romania
Sos. Pipera-Tunari nr. 1/1
building 1, 2nd floor | 077190 Voluntari, Ilfov
Tel.: +40-(0)31 421 85 68 | Email: info-RO@wago.com















Aveți întrebări despre produsele noastre?
Vă stăm la dispoziție pentru preluarea apelului la +40 (0) 31 421 85 68.

	Nr. articol: 210-505 Steel carrier rail; 35 x 7.5 mm; 1 mm thick; 2 m long; unslotted; galvanized; according to EN 60715	www.wago.com/210-505
	Nr. articol: 210-506 Steel carrier rail; 35 x 15 mm; 1.5 mm thick; 2 m long; unslotted; galvanized; similar to EN 60715	www.wago.com/210-506
	Nr. articol: 210-508 Steel carrier rail; 35 x 15 mm; 1.5 mm thick; 2 m long; slotted; galvanized; similar to EN 60715	www.wago.com/210-508
Jumper		
	Nr. articol: 210-103 Wire commoning chain; insulated; 50 connections; black	www.wago.com/210-103
	Nr. articol: 249-123 Push-in type wire jumper; insulated; wire length 180 mm; Conductor cross section 0.75 mm ²	www.wago.com/249-123
	Nr. articol: 249-125 Push-in type wire jumper; insulated; wire length 60 mm; Conductor cross section 0.75 mm ²	www.wago.com/249-125
	Nr. articol: 249-126 Push-in type wire jumper; insulated; wire length 110 mm; Conductor cross section 0.75 mm ²	www.wago.com/249-126
	Nr. articol: 249-127 Push-in type wire jumper; insulated; wire length 250 mm; Conductor cross section 0.75 mm ²	www.wago.com/249-127
	Nr. articol: 279-402 Adjacent jumper; insulated; Nominal current 15 A; gray	www.wago.com/279-402
	Nr. articol: 279-409 Alternate jumper; insulated; Nominal current 15 A; gray	www.wago.com/279-409
	Nr. articol: 279-422 Adjacent jumper; insulated; Nominal current 15 A; yellow-green	www.wago.com/279-422
	Nr. articol: 279-482 Comb-style jumper bar; insulated; 2-way; IN = IN terminal block; gray	www.wago.com/279-482
	Nr. articol: 279-483 Comb-style jumper bar; insulated; 3-way; IN = IN terminal block; gray	www.wago.com/279-483
	Nr. articol: 279-490 Comb-style jumper bar; insulated; 10-way; IN = IN terminal block; gray	www.wago.com/279-490
	Nr. articol: 279-492 Alternate comb-style jumper bar; insulated; 2-way; IN = IN terminal block; gray	www.wago.com/279-492
assembling		
	Nr. articol: 209-106 Mounting carrier; for isolated mounting on DIN 35 rails; gray	www.wago.com/209-106
	Nr. articol: 709-153 Cover; Type 1; suitable for cover carrier, type 1; 1 m long; transparent	www.wago.com/709-153
Insulation stop		

Supus modificărilor.

	Nr. articol: 279-470 Insulation stop; 0.08 - 0.2 mm ² "s" (0.14 mm ² "f-st"); 5 pieces/strip; white	www.wago.com/279-470
	Nr. articol: 279-471 Insulation stop; 0.25 mm ² ; 5 pieces/strip; dark gray	www.wago.com/279-471
check		
	Nr. articol: 209-170 Test plug adapter; 8.3 mm wide; for 4 mm Ø test plugs; suitable for 1.5 mm ² - 10 mm ² tbs; gray	www.wago.com/209-170
	Nr. articol: 280-404 Test plug adapter; 5 mm wide; for test plug 210-137 (2.3 mm Ø); suitable for 1.5 mm ² - 4 mm ² tbs; gray	www.wago.com/280-404
ferrule		
	Nr. articol: 216-101 Ferrule; Sleeve for 0.5 mm ² / AWG 22; uninsulated; electro-tin plated	www.wago.com/216-101
	Nr. articol: 216-102 Ferrule; Sleeve for 0.75 mm ² / AWG 20; uninsulated; electro-tin plated	www.wago.com/216-102
	Nr. articol: 216-103 Ferrule; Sleeve for 1 mm ² / AWG 18; uninsulated; electro-tin plated	www.wago.com/216-103
	Nr. articol: 216-201 Ferrule; Sleeve for 0.5 mm ² / 20 AWG; insulated; electro-tin plated; white	www.wago.com/216-201
	Nr. articol: 216-202 Ferrule; Sleeve for 0.75 mm ² / 18 AWG; insulated; electro-tin plated; gray	www.wago.com/216-202
	Nr. articol: 216-203 Ferrule; Sleeve for 1 mm ² / AWG 18; insulated; electro-tin plated; red	www.wago.com/216-203
	Nr. articol: 216-301 Ferrule; Sleeve for 0.25 mm ² / AWG 24; insulated; electro-tin plated; yellow	www.wago.com/216-301
	Nr. articol: 216-302 Ferrule; Sleeve for 0.34 mm ² / 22 AWG; insulated; electro-tin plated; green	www.wago.com/216-302
Marking accessories		
	Nr. articol: 2009-114 WMB-Inline; for Smart Printer; 2000 pieces on roll; stretchable 4 - 4.2 mm; plain; snap-on type; white	www.wago.com/2009-114
	Nr. articol: 2009-114/000-002 WMB-Inline; for Smart Printer; 2000 pieces on roll; stretchable 4 - 4.2 mm; plain; snap-on type; yellow	www.wago.com/2009-114/000-002
	Nr. articol: 2009-114/000-005 WMB-Inline; for Smart Printer; 2000 pieces on roll; stretchable 4 - 4.2 mm; plain; snap-on type; red	www.wago.com/2009-114/000-005
	Nr. articol: 2009-114/000-006 WMB-Inline; for Smart Printer; 2000 pieces on roll; stretchable 4 - 4.2 mm; plain; snap-on type; blue	www.wago.com/2009-114/000-006

Supus modificărilor.

	Nr. articol: 2009-114/000-007 WMB-Inline; for Smart Printer; 2000 pieces on roll; stretchable 4 - 4.2 mm; plain; snap-on type; gray	www.wago.com/2009-114/000-007
	Nr. articol: 2009-114/000-012 WMB-Inline; for Smart Printer; 2000 pieces on roll; stretchable 4 - 4.2 mm; plain; snap-on type; orange	www.wago.com/2009-114/000-012
	Nr. articol: 2009-114/000-023 WMB-Inline; for Smart Printer; 2000 pieces on roll; stretchable 4 - 4.2 mm; plain; snap-on type; green	www.wago.com/2009-114/000-023
	Nr. articol: 2009-114/000-024 WMB-Inline; for Smart Printer; 2000 pieces on roll; stretchable 4 - 4.2 mm; plain; snap-on type; violet	www.wago.com/2009-114/000-024
	Nr. articol: 209-128 Adaptor; gray	www.wago.com/209-128
	Nr. articol: 209-140 Group marker carrier; gray	www.wago.com/209-140
	Nr. articol: 209-141 Group marker carrier; gray	www.wago.com/209-141
	Nr. articol: 209-142 Group marker carrier; gray	www.wago.com/209-142
	Nr. articol: 209-185 Adaptor; gray	www.wago.com/209-185
	Nr. articol: 249-105 Group marker carrier; gray	www.wago.com/249-105
	Nr. articol: 793-4501 WMB marking card; as card; stretchable 4 - 4.2 mm; plain; snap-on type; white	www.wago.com/793-4501
	Nr. articol: 793-4501/000-002 WMB marking card; as card; stretchable 4 - 4.2 mm; plain; snap-on type; yellow	www.wago.com/793-4501/000-002
	Nr. articol: 793-4501/000-005 WMB marking card; as card; stretchable 4 - 4.2 mm; plain; snap-on type; red	www.wago.com/793-4501/000-005
	Nr. articol: 793-4501/000-006 WMB marking card; as card; stretchable 4 - 4.2 mm; plain; snap-on type; blue	www.wago.com/793-4501/000-006
	Nr. articol: 793-4501/000-007 WMB marking card; as card; stretchable 4 - 4.2 mm; plain; snap-on type; gray	www.wago.com/793-4501/000-007

Supus modificărilor.

WAGO Kontakttechnik GmbH & Co. KG
/Representative Office Romania
Sos. Pipera-Tunari nr. 1/1
building 1, 2nd floor | 077190 Voluntari, Ilfov
Tel.: +40-(0)31 421 85 68 | Email: info-RO@wago.com

Aveți întrebări despre produsele noastre?
Vă stăm la dispoziție pentru preluarea apelului la +40 (0) 31 421 85 68.



Nr. articol: 793-4501/000-012
WMB marking card; as card; stretchable 4 - 4.2 mm; plain; snap-on type; orange

www.wago.com/793-4501/000-012



Nr. articol: 793-4501/000-014
WMB marking card; as card; stretchable 4 - 4.2 mm; plain; snap-on type; brown

www.wago.com/793-4501/000-014



Nr. articol: 793-4501/000-017
WMB marking card; as card; stretchable 4 - 4.2 mm; plain; snap-on type; green

www.wago.com/793-4501/000-017



Nr. articol: 793-4501/000-023
WMB marking card; as card; stretchable 4 - 4.2 mm; plain; snap-on type; light green

www.wago.com/793-4501/000-023



Nr. articol: 793-4501/000-024
WMB marking card; as card; stretchable 4 - 4.2 mm; plain; snap-on type; violet

www.wago.com/793-4501/000-024

tools



Nr. articol: 210-647
Operating tool; Blade: 2.5 x 0.4 mm; with a partially insulated shaft

www.wago.com/210-647



Nr. articol: 210-648
Operating tool; Blade: 2.5 x 0.4 mm; with a partially insulated shaft; angled; short

www.wago.com/210-648



Nr. articol: 210-719
Operating tool; Blade: 2.5 x 0.4 mm; with a partially insulated shaft

www.wago.com/210-719

Protective Warning Marker



Nr. articol: 279-415
Protective warning marker; with high-voltage symbol, black; for 5 terminal blocks; yellow

www.wago.com/279-415

End plate



Nr. articol: 279-344
End and intermediate plate; 2 mm thick; gray

www.wago.com/279-344



Nr. articol: 279-345
Separator plate; 2 mm thick; oversized; gray

www.wago.com/279-345



Nr. articol: 279-346
End and intermediate plate; 2 mm thick; orange

www.wago.com/279-346



Nr. articol: 279-347
Separator plate; 2 mm thick; oversized; orange

www.wago.com/279-347

Descărcări

Documentation

Additional Information

Technical explanations

Apr 3, 2019

pdf

Descărcare

Supus modificărilor.

CAD/CAE-Data

CAD data

2D/3D Models 279-837	URL	Descărcare
----------------------	---------------------	----------------------------

CAE data

EPLAN Data Portal 279-837	URL	Descărcare
---------------------------	---------------------	----------------------------

WSCAD Universe 279-837	URL	Descărcare
------------------------	---------------------	----------------------------

Installation Notes

Installation

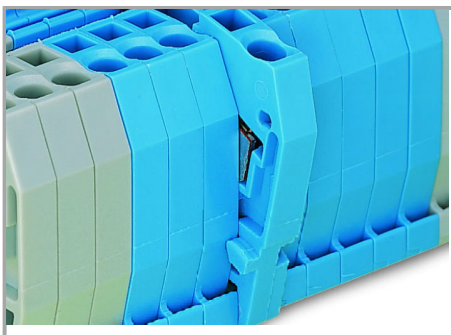

Quick assembly keys prevent reverse mounting.

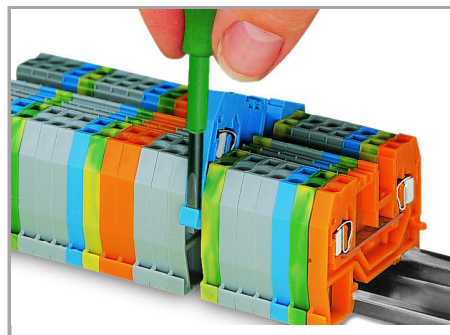

Removing a terminal block from the assembly.

Inserting a conductor

Supus modificărilor.

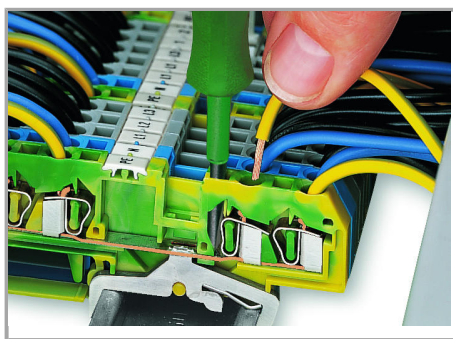

CAGE CLAMP® connection

Inserting a conductor.

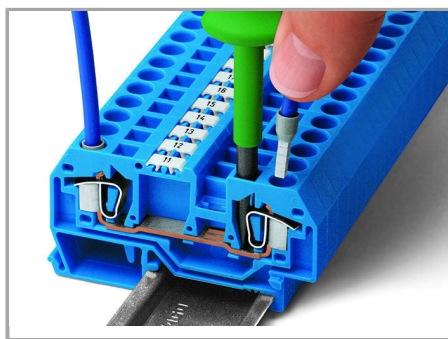

CAGE CLAMP® connection

Inserting a conductor.

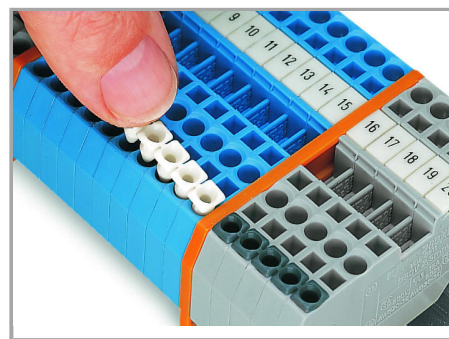

Inserting insulation stops.

With ferruled conductors, it is necessary to use a terminal block one size larger than the conductor's nominal cross-section.

Commoning

Supus modificărilor.

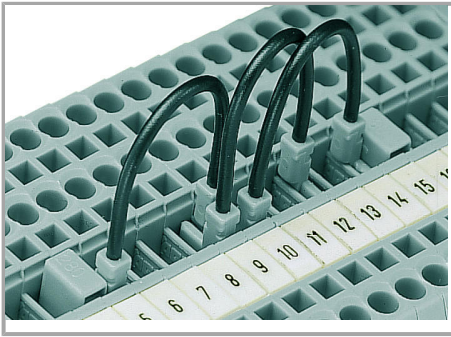

Supus modificărilor.

WAGO Kontakttechnik GmbH & Co. KG
/Representative Office Romania
Sos. Pipera-Tunari nr. 1/1
building 1, 2nd floor | 077190 Voluntari, Ilfov
Tel.: +40-(0)31 421 85 68 | Email: info-RO@wago.com

Aveți întrebări despre produsele noastre?

Vă stăm la dispoziție pentru preluarea apelului la +40 (0) 31 421 85 68.



Wire jumpers

When installing machines or control systems, it is often necessary to make an additional connection between two terminal blocks that are not next to each other on the rail. In such cases, WAGO's touch-proof, push-in type wire jumpers are the ideal solution.

These jumpers are compatible with the following rail-mount terminal blocks:

- 279 Series (1.5 mm²/16 AWG),
-
- 280/775/780 Series (2.5 mm²/14 AWG)
-
- 281/769/776/777/781 and 880 Series (4 mm²/12 AWG)
-

They are available in three conductor lengths (60, 110 and 250 mm), allowing up to 60 terminal blocks to be commoned depending on their width (see table on the right).

Compared with the 279 Series, the 280/775/780 and 281/776/777/781 Series can also accommodate two wire jumpers, allowing the use of commoning chains. Furthermore, the 280/769/775/780/880 and 281/776/777/781 Series allow both wire jumper and adjacent jumper to be simultaneously plugged into a same terminal block.

Testing

Supus modificărilor.

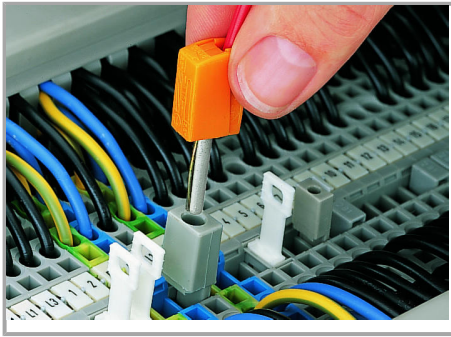

Testing with a test plug

(picture shows 209-170 Test Plug Adapter).

Marking

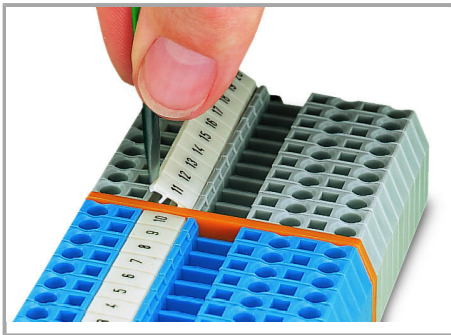

Marking via WMB Multi Marking System.

Supus modificărilor.