

## Fișă tehnică | Număr articol: 770-657

3-way distribution connector; 3-pole; Cod. A; 1 input; 3 outputs; white

[www.wago.com/770-657](http://www.wago.com/770-657)

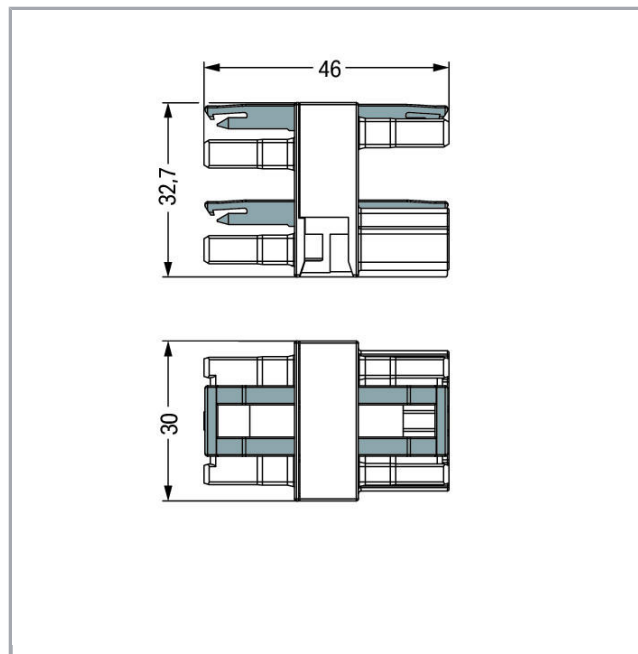
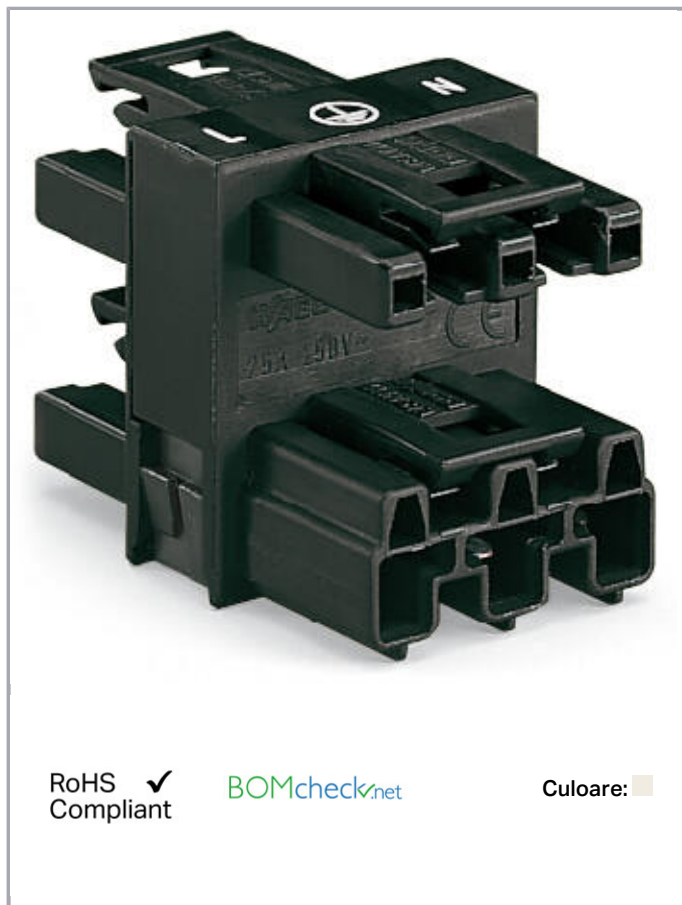

### Descriere articol

- Protected against mismatching and maintenance-free
- Additional variable coding is possible

#### Note:

All connectors for mounted installations (snap-in versions for lighting fixtures or devices, all types of PCB and distribution connectors) are factory-equipped with locking levers to ensure plugs and sockets are securely locked. Additional locking levers are only required for flying leads (plug /socket).

#### Note on mismatching protection:

All WINSTA<sup>®</sup> components are 100% protected against mismatching when:

- plugging different numbers of poles
- plugging while rotated 180

Supus modificărilor.

WAGO Kontakttechnik GmbH & Co. KG  
/Representative Office Romania  
Sos. Pipera-Tunari nr. 1/1  
building 1, 2nd floor | 077190 Voluntari, Ilfov  
Tel.: +40-(0)31 421 85 68 | Email: info-RO@wago.com

Aveți întrebări despre produsele noastre?  
Vă stăm la dispoziție pentru preluarea apelului la +40 (0) 31 421 85 68.



c.) plugging while laterally staggered

d.) plugging one pole

**Safety information 1:**

Application note for the U.S. market (USR): Some versions may also be used for current interruption in accordance with the UL certificate in select applications with currents below 16 A and voltages up to 600 V. For further information, please contact your local sales office.

**Date****Electrical data**

Note on Contact Resistance	approx. 1 mΩ of contact resistance approx. 0.25 mΩ contact transition plug/socket
----------------------------	---

**Ratings per IEC/EN 60664-1**

Ratings per	IEC/EN 60664-1
Nominal voltage (III/3)	250 V
Rated surge voltage (III/3)	4 kV
Rated current	25 A
Legend (ratings)	(III / 3) ≙ Overvoltage category III / Pollution degree 3

**Approvals per UL 1977**

Rated voltage UL 1977	600 V
Rated current UL 1977	23 A

**Connection data**

Pole No.	3
Total number of potentials	3
Ground function	with preceding ground contact

**Geometrical Data**

Pin spacing	10 mm / 0.394 inch
Width	30 mm / 1.181 inch
Height	32,7 mm / 1.287 inch
Depth	46 mm / 1.811 inch

**Mechanical data**

Coding	A
Mating force of a plug-in connection	approx. 20 ... 70 N (depending on pole number)
Retention force of a plug-in connection	When locked: > 80 N

Supus modificărilor.

WAGO Kontakttechnik GmbH & Co. KG  
 /Representative Office Romania  
 Sos. Pipera-Tunari nr. 1/1  
 building 1, 2nd floor | 077190 Voluntari, Ilfov  
 Tel.: +40-(0)31 421 85 68 | Email: info-RO@wago.com

Aveți întrebări despre produsele noastre?  
 Vă stăm la dispoziție pentru preluarea apelului la +40 (0) 31 421 85 68.



Unmating force of a plug-in connection	when unlocked: approx. 20 ... 70 N (depending on pole number)
Number of mating cycles	200, without resistive load 100, with resistive load $I_N = 25$ A, tested (4 mm <sup>2</sup> /AWG 12)
Distributor type	Distribution connector, 3-way,
Marking	L N
Protection type	IP20
Note on protection type	Only when mated (these compact connectors are not designed for use in open, easily accessible areas).
Potential marking	L N
Application	General mains applications

### Plug connection

Contact type (pluggable connector)	Socket/plug
Mismating protection	Yes
Locking of plug-in connection	locking lever
Locking lever	yes

### Material Data

Color	white
Insulation material	Polyamide 66 (PA 66)
Contact material	Copper or copper alloy (surface-treated)
Fire load	0,426 MJ
Weight	25,5 g

### Environmental Requirements

Processing temperature	-5 ... +40 °C
Continuous operating temperature	-35 ... +85 °C
Note on continuous operating temperature	Insulating parts for temperatures $\leq 105$ °C

### Commercial data

Packaging type	BOX
Country of origin	DE
GTIN	4045454251512
Customs tariff number	85366990990

Supus modificărilor.

WAGO Kontakttechnik GmbH & Co. KG  
 /Representative Office Romania  
 Sos. Pipera-Tunari nr. 1/1  
 building 1, 2nd floor | 077190 Voluntari, Ilfov  
 Tel.: +40-(0)31 421 85 68 | Email: info-RO@wago.com



Aveți întrebări despre produsele noastre?  
 Vă stăm la dispoziție pentru preluarea apelului la +40 (0) 31 421 85 68.

## Aprobări / certificate

## Country specific Approvals

Emblemă	Aprobare	Text de aprobare suplimentar	Nume certificat
	CCA DEKRA Certification B.V.	EN 61535	2173495.02



## Ship Approvals

Emblemă	Aprobare	Text de aprobare suplimentar	Nume certificat
	ABS American Bureau of Shipping	-	19- HG1868589- PDA
	DNV GL Det Norske Veritas, Germanischer Lloyd	-	TAE00001Z6
	LR Lloyds Register	IEC 61984	02/20050 (E6)

## UL-Approvals

Emblemă	Aprobare	Text de aprobare suplimentar	Nume certificat
	cURus Underwriters Laboratories Inc.	UL 1977	E45171 Sec. 9

## Counterpart

	Nr. articol770-123 Socket; with strain relief housing; 3-pole; Cod. A; 4,00 mm <sup>2</sup> ; white	<a href="http://www.wago.com/770-123">www.wago.com/770-123</a>
	Nr. articol770-133 Plug; with strain relief housing; 3-pole; Cod. A; 4,00 mm <sup>2</sup> ; white	<a href="http://www.wago.com/770-133">www.wago.com/770-133</a>

Supus modificărilor.

WAGO Kontakttechnik GmbH & Co. KG  
/Representative Office Romania  
Sos. Pipera-Tunari nr. 1/1  
building 1, 2nd floor | 077190 Voluntari, Ilfov  
Tel.: +40-(0)31 421 85 68 | Email: info-RO@wago.com

Aveți întrebări despre produsele noastre?  
Vă stăm la dispoziție pentru preluarea apelului la +40 (0) 31 421 85 68.



**Nr. articol**770-223

Socket; 3-pole; Cod. A; 4,00 mm<sup>2</sup>; white

[www.wago.com/770-223](http://www.wago.com/770-223)



**Nr. articol**770-223/035-050

Socket; with strain relief housing; 3-pole; Cod. A; 4,00 mm<sup>2</sup>; white

[www.wago.com/770-223/035-050](http://www.wago.com/770-223/035-050)



**Nr. articol**770-233

Plug; 3-pole; Cod. A; 4,00 mm<sup>2</sup>; white

[www.wago.com/770-233](http://www.wago.com/770-233)



**Nr. articol**770-233/035-050

Plug; with strain relief housing; 3-pole; Cod. A; 4,00 mm<sup>2</sup>; white

[www.wago.com/770-233/035-050](http://www.wago.com/770-233/035-050)



**Nr. articol**771-9993/006-102

pre-assembled interconnecting cable; Eca; Socket/plug; 3-pole; Cod. A; H05VV-F 3G 1.5 mm<sup>2</sup>; 1 m; 1,50 mm<sup>2</sup>; white

[www.wago.com/771-9993/006-102](http://www.wago.com/771-9993/006-102)



**Nr. articol**771-9993/106-102

pre-assembled connecting cable; Eca; Socket/open-ended; 3-pole; Cod. A; H05VV-F 3G 1.5 mm<sup>2</sup>; 1 m; 1,50 mm<sup>2</sup>; white

[www.wago.com/771-9993/106-102](http://www.wago.com/771-9993/106-102)



**Nr. articol**771-9993/206-102

pre-assembled connecting cable; Eca; Plug/open-ended; 3-pole; Cod. A; H05VV-F 3G 1.5 mm<sup>2</sup>; 1 m; 1,50 mm<sup>2</sup>; white

[www.wago.com/771-9993/206-102](http://www.wago.com/771-9993/206-102)

## Descărcări

### CAD/CAE-Data

#### CAD data

2D/3D Models 770-657

[URL](#)

[Descărcare](#)

#### CAE data

EPLAN Data Portal 770-657

[URL](#)

[Descărcare](#)

WSCAD Universe 770-657

[URL](#)

[Descărcare](#)

## Installation Notes

### Installation

Supus modificărilor.

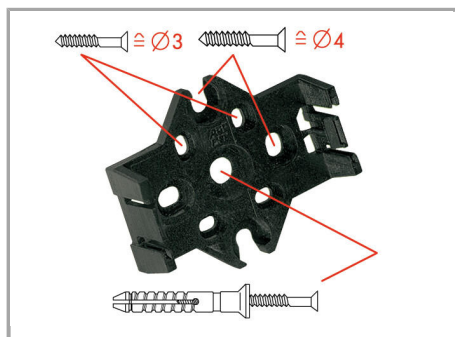

The mounting plate for distribution connectors can be mounted using commercially available screws or nail-drive anchors.



The distribution connectors are latched when mounted on the mounting plate.



To release the distribution connector, unlock the latch using a screwdriver.

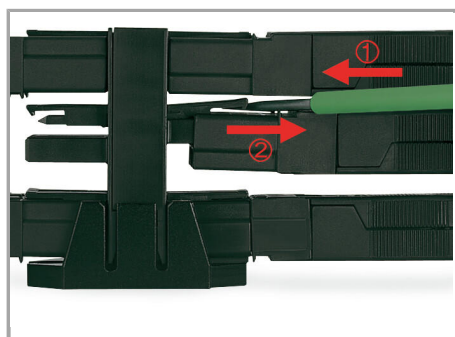

All distributor connections are locked and protected against accidental disconnection directly after mating. Locking of any connection is released using a screwdriver, even if all connections are in use.

## Familie de produse

*WINSTA*® MIDI

Afișare globală produse din familie.

Supus modificărilor.