

## Fișă tehnică | Număr articol: 280-904

2-conductor through terminal block; 2.5 mm<sup>2</sup>; suitable for Ex i applications; center marking; for DIN-rail 35 x 15 and 35 x 7.5; CAGE CLAMP®; 2,50 mm<sup>2</sup>; blue

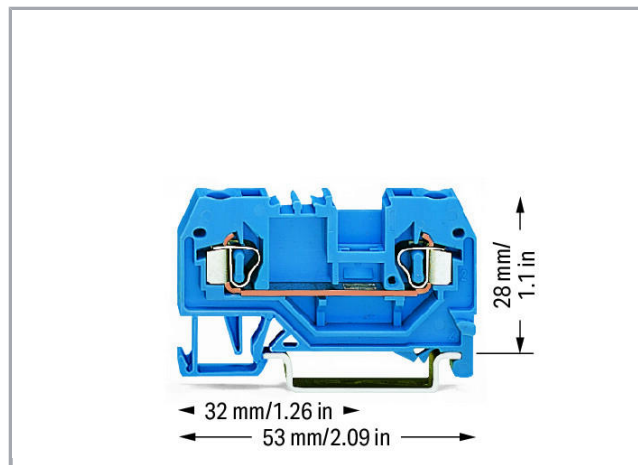

[www.wago.com/280-904](http://www.wago.com/280-904)

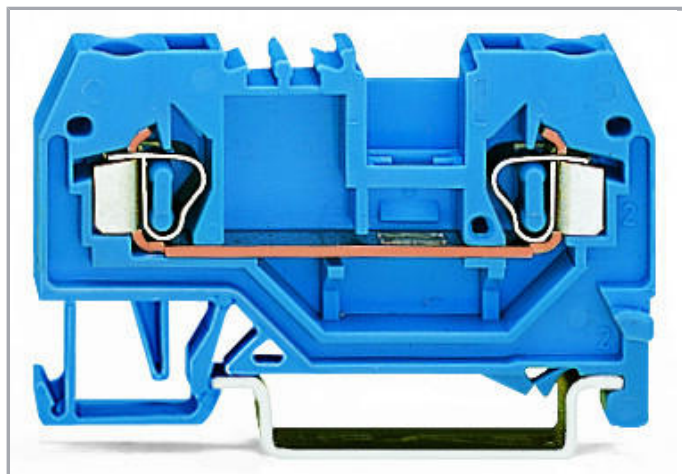

RoHS  Compliant

BOMcheck.net

Culoare: ■

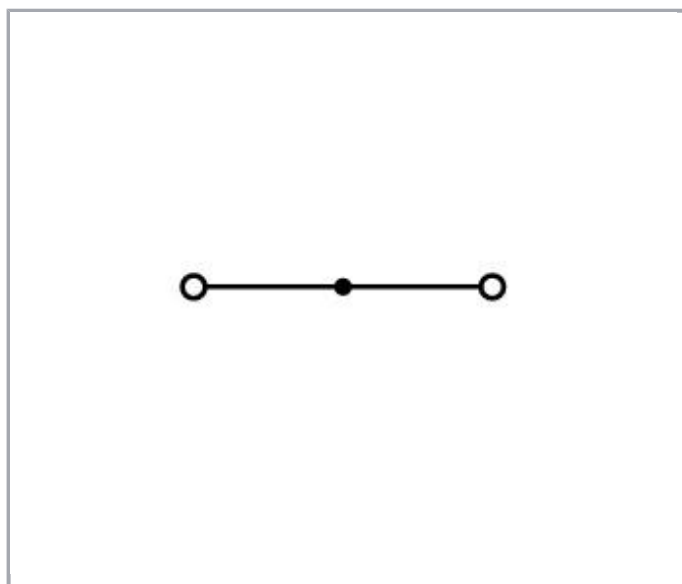

### Descriere articol

Supus modificărilor.

WAGO Kontakttechnik GmbH & Co. KG  
/Representative Office Romania  
Sos. Pipera-Tunari nr. 1/1  
building 1, 2nd floor | 077190 Voluntari, Ilfov  
Tel.: +40-(0)31 421 85 68 | Email: info-RO@wago.com

Aveți întrebări despre produsele noastre?  
Vă stăm la dispoziție pentru preluarea apelului la +40 (0) 31 421 85 68.

**Note:****Terminating Aluminum Conductors**

WAGO spring clamp terminal blocks are suitable for solid aluminum conductors up to 4 mm<sup>2</sup>/12 AWG if WAGO "Alu-Plus" Contact Paste is used for termination.

"Alu-Plus" Contact Paste Advantages:

- Automatically destroys the oxide film during clamping.
- Prevents fresh oxidation at the clamping point.
- Prevents electrolytic corrosion between aluminum and copper conductors (in the same terminal block).
- Provides long-term protection against corrosion.

Using terminal blocks with CAGE CLAMP® Spring Pressure Connection Technology, **aluminum conductors must first be cleaned with a blade** and then immediately be inserted into the clamping units filled with "Alu-Plus" Contact Paste.

It is also possible to apply WAGO "Alu-Plus" **additionally** on the whole surface of the aluminum conductor before termination.

Please note that the nominal currents must be adapted to the reduced conductivity of the aluminum conductors::

2.5 mm<sup>2</sup> = 16 A

4 mm<sup>2</sup> = 22 A

**Date****Electrical data****Ratings per IEC/EN 60664-1**

|                             |   |
|-----------------------------|---|
| Ratings per                 | IEC/EN 60947-7-1  |
| Nominal voltage (III/3)     | 800 V   |
| Rated surge voltage (III/3) | 8 kV  |
| Rated current               | 24 A  |
| Legend (ratings)            | (III / 3) ± Overvoltage category III / Pollution degree 3 |

**Connection data**

|                                   |  |
|-----------------------------------|--|
| Connection technology             | CAGE CLAMP®                                  |
| Actuation type                    | Operating tool                               |
| Connectable conductor materials   | Copper<br>Aluminum                           |
| Solid conductor                   | 0,08 ... 2,5 mm <sup>2</sup> / 28 ... 12 AWG |
| Fine-stranded conductor           | 0,08 ... 2,5 mm <sup>2</sup> / 28 ... 12 AWG |
| Strip length                      | 8 ... 9 mm / 0.31 ... 0.35 inch              |
| Total number of connection points | 2  |

Supus modificărilor.

WAGO Kontakttechnik GmbH & Co. KG  
/Representative Office Romania  
Sos. Pipera-Tunari nr. 1/1  
building 1, 2nd floor | 077190 Voluntari, Ilfov  
Tel.: +40-(0)31 421 85 68 | Email: info-RO@wago.com

Aveți întrebări despre produsele noastre?  
Vă stăm la dispoziție pentru preluarea apelului la +40 (0) 31 421 85 68.



|                                |                    |
|--------------------------------|--------------------|
| Total number of potentials     | 1                  |
| Number of levels               | 1                  |
| Wiring type                    | Front-entry wiring |
| Note (conductor cross-section) | 12 AWG: THHN, THWN |

**Geometrical Data**

|                                    |                    |
|------------------------------------|--------------------|
| Width                              | 5 mm / 0.197 inch  |
| Height from upper-edge of DIN-rail | 28 mm / 1.102 inch |
| Depth                              | 53 mm / 2.087 inch |

**Mechanical data**

|               |                 |
|---------------|-----------------|
| Design        | horizontal type |
| Mounting type | DIN-35 rail     |
| Marking level | Center marking  |

**Material Data**

|                     |                      |
|---------------------|----------------------|
| Color               | blue                 |
| Insulation material | Polyamide 66 (PA 66) |
| Fire load           | 0,106 MJ             |
| Weight              | 5,7 g                |

**Commercial data**

|                       |               |
|-----------------------|---------------|
| Packaging type        | BOX           |
| Country of origin     | DE            |
| GTIN                  | 4044918391870 |
| Customs tariff number | 85369010000   |

**Aprobări / certificate****Country specific Approvals**

| Emblemă | Aprobare                               | Text de aprobare suplimentar | Nume certificat |
|---------|--|------------------------------|-----------------|
|         | <b>CCA</b><br>DEKRA Certification B.V. | EN 60947                     | 2157201.01      |
|         | <b>CSA</b><br>DEKRA Certification B.V. | C22.2                        | 1536071         |





Supus modificărilor.

WAGO Kontakttechnik GmbH & Co. KG  
 /Representative Office Romania  
 Sos. Pipera-Tunari nr. 1/1  
 building 1, 2nd floor | 077190 Voluntari, Ilfov  
 Tel.: +40-(0)31 421 85 68 | Email: info-RO@wago.com

Aveți întrebări despre produsele noastre?  
 Vă stăm la dispoziție pentru preluarea apelului la +40 (0) 31 421 85 68.



## Ship Approvals

| Emblemă  | Aprobare  | Text de aprobare suplimentar | Nume certificat          |
|--|---|------------------------------|--------------------------|
|    | <b>ABS</b><br>American Bureau of Shipping               | EN 60947                     | 20-<br>HG1941090-<br>PDA |
|   | <b>BV</b><br>Bureau Veritas S.A.                        | EN 60947                     | 07436/E0 BV              |
|    | <b>DNV GL</b><br>Det Norske Veritas, Germanischer Lloyd | -                            | TAE00001V2               |
|  | <b>LR</b><br>Lloyds Register                            | EN 60947                     | 91/20112<br>(E9)         |

## UL-Approvals

| Emblemă  | Aprobare                                    | Text de aprobare suplimentar | Nume certificat     |
|--|---|------------------------------|---------------------|
|  | <b>UL</b><br>Underwriters Laboratories Inc. | UL 1059                      | 20170731-<br>E45172 |

## Counterpart

















## Produse compatibile

Supus modificărilor.

WAGO Kontakttechnik GmbH & Co. KG  
 /Representative Office Romania  
 Sos. Pipera-Tunari nr. 1/1  
 building 1, 2nd floor | 077190 Voluntari, Ilfov  
 Tel.: +40-(0)31 421 85 68 | Email: info-RO@wago.com

Aveți întrebări despre produsele noastre?  
 Vă stăm la dispoziție pentru preluarea apelului la +40 (0) 31 421 85 68.

## Jumper

|  |  |  |
|--|--|--|
|    | <b>Nr. articol: 210-103</b><br>Wire commoning chain; insulated; 50 connections; black                                    | <a href="http://www.wago.com/210-103">www.wago.com/210-103</a> |
|    | <b>Nr. articol: 210-123</b><br>Wire commoning chain; insulated; 50 connections   | <a href="http://www.wago.com/210-123">www.wago.com/210-123</a> |
|    | <b>Nr. articol: 249-123</b><br>Push-in type wire jumper; insulated; wire length 180 mm; Conductor cross section 0.75 mm² | <a href="http://www.wago.com/249-123">www.wago.com/249-123</a> |
|    | <b>Nr. articol: 249-125</b><br>Push-in type wire jumper; insulated; wire length 60 mm; Conductor cross section 0.75 mm²  | <a href="http://www.wago.com/249-125">www.wago.com/249-125</a> |
|    | <b>Nr. articol: 249-126</b><br>Push-in type wire jumper; insulated; wire length 110 mm; Conductor cross section 0.75 mm² | <a href="http://www.wago.com/249-126">www.wago.com/249-126</a> |
|    | <b>Nr. articol: 249-127</b><br>Push-in type wire jumper; insulated; wire length 250 mm; Conductor cross section 0.75 mm² | <a href="http://www.wago.com/249-127">www.wago.com/249-127</a> |
|   | <b>Nr. articol: 280-402</b><br>Adjacent jumper; insulated; IN = IN terminal block; gray                                  | <a href="http://www.wago.com/280-402">www.wago.com/280-402</a> |
|  | <b>Nr. articol: 280-409</b><br>Alternate jumper; insulated; IN = IN terminal block; gray                                 | <a href="http://www.wago.com/280-409">www.wago.com/280-409</a> |
|  | <b>Nr. articol: 280-422</b><br>Adjacent jumper; insulated; IN = IN terminal block; yellow-green                          | <a href="http://www.wago.com/280-422">www.wago.com/280-422</a> |
|  | <b>Nr. articol: 280-482</b><br>Comb-style jumper bar; insulated; 2-way; IN = IN terminal block; gray                     | <a href="http://www.wago.com/280-482">www.wago.com/280-482</a> |
|  | <b>Nr. articol: 280-483</b><br>Comb-style jumper bar; insulated; 3-way; IN = IN terminal block; gray                     | <a href="http://www.wago.com/280-483">www.wago.com/280-483</a> |
|  | <b>Nr. articol: 280-484</b><br>Comb-style jumper bar; insulated; 4-way; IN = IN terminal block; gray                     | <a href="http://www.wago.com/280-484">www.wago.com/280-484</a> |
|  | <b>Nr. articol: 280-485</b><br>Comb-style jumper bar; insulated; 5-way; IN = IN terminal block; gray                     | <a href="http://www.wago.com/280-485">www.wago.com/280-485</a> |
|  | <b>Nr. articol: 280-490</b><br>Comb-style jumper bar; insulated; 10-way; IN = IN terminal block; gray                    | <a href="http://www.wago.com/280-490">www.wago.com/280-490</a> |
|  | <b>Nr. articol: 280-492</b><br>Alternate comb-style jumper bar; insulated; 2-way; IN = IN terminal block; gray           | <a href="http://www.wago.com/280-492">www.wago.com/280-492</a> |
|  | <b>Nr. articol: 284-414</b><br>Step-down jumper; insulated; from 10/6 mm² to 4/2.5/1.5 mm²; Nominal current 15 A; gray   | <a href="http://www.wago.com/284-414">www.wago.com/284-414</a> |

Supus modificărilor.



**Nr. articol: 709-110**  
Wire commoning chain; insulated; 4 connections; 3 x 110 mm; black

[www.wago.com/709-110](http://www.wago.com/709-110)



**Nr. articol: 709-111**  
Wire commoning chain; insulated; 3 connections; 2 x 120 mm; black

[www.wago.com/709-111](http://www.wago.com/709-111)



**Nr. articol: 709-112**  
Wire commoning chain; insulated; 3 connections; 2 x 170 mm; black

[www.wago.com/709-112](http://www.wago.com/709-112)



**Nr. articol: 780-452**  
Staggered jumper; insulated; from 1 to 2; Spacing: 5 mm; suitable for 2-conductor female plugs; gray

[www.wago.com/780-452](http://www.wago.com/780-452)



**Nr. articol: 780-453**  
Staggered jumper; insulated; from 1 to 3; Spacing: 5 mm; suitable for 2-conductor female plugs; gray

[www.wago.com/780-453](http://www.wago.com/780-453)



**Nr. articol: 780-454**  
Staggered jumper; insulated; from 1 to 4; Spacing: 5 mm; suitable for 2-conductor female plugs; gray

[www.wago.com/780-454](http://www.wago.com/780-454)



**Nr. articol: 780-455**  
Staggered jumper; insulated; from 1 to 5; Spacing: 5 mm; suitable for 2-conductor female plugs; gray

[www.wago.com/780-455](http://www.wago.com/780-455)



**Nr. articol: 780-456**  
Staggered jumper; insulated; from 1 to 6; Spacing: 5 mm; suitable for 2-conductor female plugs; gray

[www.wago.com/780-456](http://www.wago.com/780-456)



**Nr. articol: 780-457**  
Staggered jumper; insulated; from 1 to 7; Spacing: 5 mm; suitable for 2-conductor female plugs; gray

[www.wago.com/780-457](http://www.wago.com/780-457)



**Nr. articol: 780-458**  
Staggered jumper; insulated; from 1 to 8; Spacing: 5 mm; suitable for 2-conductor female plugs; gray

[www.wago.com/780-458](http://www.wago.com/780-458)

#### assembling



**Nr. articol: 209-106**  
Mounting carrier; for isolated mounting on DIN 35 rails; gray

[www.wago.com/209-106](http://www.wago.com/209-106)



**Nr. articol: 210-148**  
Angled support bracket; without screw

[www.wago.com/210-148](http://www.wago.com/210-148)



**Nr. articol: 709-153**  
Cover; Type 1; suitable for cover carrier, type 1; 1 m long; transparent

[www.wago.com/709-153](http://www.wago.com/709-153)

#### check



**Nr. articol: 209-170**  
Test plug adapter; 8.3 mm wide; for 4 mm Ø test plugs; suitable for 1.5 mm<sup>2</sup> - 10 mm<sup>2</sup> tbs; gray

[www.wago.com/209-170](http://www.wago.com/209-170)



**Nr. articol: 249-106**  
B-type test plug module; modular; 1,50 mm<sup>2</sup>; gray

[www.wago.com/249-106](http://www.wago.com/249-106)



**Nr. articol: 249-107**  
B-type spacer module; modular; e.g., for bridging commoned terminal blocks; gray

[www.wago.com/249-107](http://www.wago.com/249-107)

















**Nr. articol: 249-141**  
L-type test plug module; modular; with spring-loaded contact pin; Center module; 1,50 mm<sup>2</sup>; gray













[www.wago.com/249-141](http://www.wago.com/249-141)

**Nr. articol: 249-142**

Supus modificărilor.

|   |  |  |
|---|--|--|
|    | L-type end module; modular; with rigid contact pin; End module; 1,50 mm <sup>2</sup> ; gray  | <a href="http://www.wago.com/249-142">www.wago.com/249-142</a>                                 |
|    | <b>Nr. articol: 249-143</b><br>L-type spacer module; modular; e.g., bridging commoned terminal blocks; gray  | <a href="http://www.wago.com/249-143">www.wago.com/249-143</a>                                 |
|    | <b>Nr. articol: 280-404</b><br>Test plug adapter; 5 mm wide; for test plug 210-137 (2.3 mm Ø); suitable for 1.5 mm <sup>2</sup> - 4 mm <sup>2</sup> tbs; gray              | <a href="http://www.wago.com/280-404">www.wago.com/280-404</a>                                 |
|    | <b>Nr. articol: 280-418</b><br>Test plug module; modular; suitable for all WAGO 280 and 780 Series rail-mounted terminal blocks with jumper slots in the current bar; gray | <a href="http://www.wago.com/280-418">www.wago.com/280-418</a>                                 |
|    | <b>Nr. articol: 280-419</b><br>Spacer module; modular; bridging commoned terminal blocks; gray   | <a href="http://www.wago.com/280-419">www.wago.com/280-419</a>                                 |
| <b>tools</b>  |  |  |
|    | <b>Nr. articol: 210-657</b><br>Operating tool; Blade: 3.5 x 0.5 mm; with a partially insulated shaft; short  | <a href="http://www.wago.com/210-657">www.wago.com/210-657</a>                                 |
|    | <b>Nr. articol: 210-658</b><br>Operating tool; Blade: 3.5 x 0.5 mm; with a partially insulated shaft; angled; short  | <a href="http://www.wago.com/210-658">www.wago.com/210-658</a>                                 |
|    | <b>Nr. articol: 210-720</b><br>Operating tool; Blade: 3.5 x 0.5 mm; with a partially insulated shaft   | <a href="http://www.wago.com/210-720">www.wago.com/210-720</a>                                 |
| <b>Insulation stop</b>  |  |  |
|   | <b>Nr. articol: 280-470</b><br>Insulation stop; 0.08 - 0.2 mm <sup>2</sup> "s" (0.14 mm <sup>2</sup> "f-st"); 5 pieces/strip; white  | <a href="http://www.wago.com/280-470">www.wago.com/280-470</a>                                 |
|  | <b>Nr. articol: 280-471</b><br>Insulation stop; 0.25 - 0.5 mm <sup>2</sup> ; 5 pieces/strip; light gray  | <a href="http://www.wago.com/280-471">www.wago.com/280-471</a>                                 |
|  | <b>Nr. articol: 280-472</b><br>Insulation stop; 0.75 - 1 mm <sup>2</sup> ; 5 pieces/strip  | <a href="http://www.wago.com/280-472">www.wago.com/280-472</a>                                 |
| <b>Female plug</b>  |  |  |
|  | <b>Nr. articol: 232-132/005-000</b><br>Female connector for rail-mount terminal blocks; 0.6 x 1 mm pins; straight; Pin spacing 5 mm; 2-pole; gray                          | <a href="http://www.wago.com/232-132/005-000">www.wago.com/232-132/005-000</a>                 |
|  | <b>Nr. articol: 232-132/005-000/039-000</b><br>Female connector for rail-mount terminal blocks; 0.6 x 1 mm pins; straight; Locking lever; Pin spacing 5 mm; 2-pole; gray   | <a href="http://www.wago.com/232-132/005-000/039-000">www.wago.com/232-132/005-000/039-000</a> |
|  | <b>Nr. articol: 232-133/005-000</b><br>Female connector for rail-mount terminal blocks; 0.6 x 1 mm pins; straight; Pin spacing 5 mm; 3-pole; gray                          | <a href="http://www.wago.com/232-133/005-000">www.wago.com/232-133/005-000</a>                 |
|  | <b>Nr. articol: 232-133/005-000/039-000</b><br>Female connector for rail-mount terminal blocks; 0.6 x 1 mm pins; straight; Locking lever; Pin spacing 5 mm; 3-pole; gray   | <a href="http://www.wago.com/232-133/005-000/039-000">www.wago.com/232-133/005-000/039-000</a> |

Supus modificărilor.

|  |  |  |
|--|--|--|
|    | <b>Nr. articol: 232-134/005-000</b><br>Female connector for rail-mount terminal blocks; 0.6 x 1 mm pins; straight; Pin spacing 5 mm; 4-pole; gray                        | <a href="http://www.wago.com/232-134/005-000">www.wago.com/232-134/005-000</a>                 |
|    | <b>Nr. articol: 232-134/005-000/039-000</b><br>Female connector for rail-mount terminal blocks; 0.6 x 1 mm pins; straight; Locking lever; Pin spacing 5 mm; 4-pole; gray | <a href="http://www.wago.com/232-134/005-000/039-000">www.wago.com/232-134/005-000/039-000</a> |
|    | <b>Nr. articol: 232-135/005-000</b><br>Female connector for rail-mount terminal blocks; 0.6 x 1 mm pins; straight; Pin spacing 5 mm; 5-pole; gray                        | <a href="http://www.wago.com/232-135/005-000">www.wago.com/232-135/005-000</a>                 |
|    | <b>Nr. articol: 232-135/005-000/039-000</b><br>Female connector for rail-mount terminal blocks; 0.6 x 1 mm pins; straight; Locking lever; Pin spacing 5 mm; 5-pole; gray | <a href="http://www.wago.com/232-135/005-000/039-000">www.wago.com/232-135/005-000/039-000</a> |
|    | <b>Nr. articol: 232-136/005-000</b><br>Female connector for rail-mount terminal blocks; 0.6 x 1 mm pins; straight; Pin spacing 5 mm; 6-pole; gray                        | <a href="http://www.wago.com/232-136/005-000">www.wago.com/232-136/005-000</a>                 |
|    | <b>Nr. articol: 232-136/005-000/039-000</b><br>Female connector for rail-mount terminal blocks; 0.6 x 1 mm pins; straight; Locking lever; Pin spacing 5 mm; 6-pole; gray | <a href="http://www.wago.com/232-136/005-000/039-000">www.wago.com/232-136/005-000/039-000</a> |
|    | <b>Nr. articol: 232-137/005-000</b><br>Female connector for rail-mount terminal blocks; 0.6 x 1 mm pins; straight; Pin spacing 5 mm; 7-pole; gray                        | <a href="http://www.wago.com/232-137/005-000">www.wago.com/232-137/005-000</a>                 |
|  | <b>Nr. articol: 232-137/005-000/039-000</b><br>Female connector for rail-mount terminal blocks; 0.6 x 1 mm pins; straight; Locking lever; Pin spacing 5 mm; 7-pole; gray | <a href="http://www.wago.com/232-137/005-000/039-000">www.wago.com/232-137/005-000/039-000</a> |
|  | <b>Nr. articol: 232-138/005-000</b><br>Female connector for rail-mount terminal blocks; 0.6 x 1 mm pins; straight; Pin spacing 5 mm; 8-pole; gray                        | <a href="http://www.wago.com/232-138/005-000">www.wago.com/232-138/005-000</a>                 |
|  | <b>Nr. articol: 232-138/005-000/039-000</b><br>Female connector for rail-mount terminal blocks; 0.6 x 1 mm pins; straight; Locking lever; Pin spacing 5 mm; 8-pole; gray | <a href="http://www.wago.com/232-138/005-000/039-000">www.wago.com/232-138/005-000/039-000</a> |
|  | <b>Nr. articol: 232-139/005-000</b><br>Female connector for rail-mount terminal blocks; 0.6 x 1 mm pins; straight; Pin spacing 5 mm; 9-pole; gray                        | <a href="http://www.wago.com/232-139/005-000">www.wago.com/232-139/005-000</a>                 |
|  | <b>Nr. articol: 232-139/005-000/039-000</b><br>Female connector for rail-mount terminal blocks; 0.6 x 1 mm pins; straight; Locking lever; Pin spacing 5 mm; 9-pole; gray | <a href="http://www.wago.com/232-139/005-000/039-000">www.wago.com/232-139/005-000/039-000</a> |
|  | <b>Nr. articol: 232-140/005-000</b><br>Female connector for rail-mount terminal blocks; 0.6 x 1 mm pins; straight; Pin spacing 5 mm; 10-pole; gray                       | <a href="http://www.wago.com/232-140/005-000">www.wago.com/232-140/005-000</a>                 |













**Nr. articol: 232-140/005-000/039-000**

Supus modificărilor.

WAGO Kontakttechnik GmbH & Co. KG  
/Representative Office Romania  
Sos. Pipera-Tunari nr. 1/1  
building 1, 2nd floor | 077190 Voluntari, Ilfov  
Tel.: +40-(0)31 421 85 68 | Email: info-RO@wago.com

Aveți întrebări despre produsele noastre?  
Vă stăm la dispoziție pentru preluarea apelului la +40 (0) 31 421 85 68.



|  |   |  |
|--|---|--|
|    | Female connector for rail-mount terminal blocks; 0.6 x 1 mm pins; straight; Locking lever; Pin spacing 5 mm; 10-pole; gray  | <a href="http://www.wago.com/232-140/005-000/039-000">www.wago.com/232-140/005-000/039-000</a> |
|    | <b>Nr. articol: 232-142/005-000</b><br>Female connector for rail-mount terminal blocks; 0.6 x 1 mm pins; straight; Pin spacing 5 mm; 12-pole; gray                        | <a href="http://www.wago.com/232-142/005-000">www.wago.com/232-142/005-000</a>                 |
|    | <b>Nr. articol: 232-142/005-000/039-000</b><br>Female connector for rail-mount terminal blocks; 0.6 x 1 mm pins; straight; Locking lever; Pin spacing 5 mm; 12-pole; gray | <a href="http://www.wago.com/232-142/005-000/039-000">www.wago.com/232-142/005-000/039-000</a> |
|    | <b>Nr. articol: 232-146/005-000</b><br>Female connector for rail-mount terminal blocks; 0.6 x 1 mm pins; straight; Pin spacing 5 mm; 16-pole; gray                        | <a href="http://www.wago.com/232-146/005-000">www.wago.com/232-146/005-000</a>                 |
|    | <b>Nr. articol: 232-146/005-000/039-000</b><br>Female connector for rail-mount terminal blocks; 0.6 x 1 mm pins; straight; Locking lever; Pin spacing 5 mm; 16-pole; gray | <a href="http://www.wago.com/232-146/005-000/039-000">www.wago.com/232-146/005-000/039-000</a> |
|    | <b>Nr. articol: 232-147/005-000/039-000</b><br>Female connector for rail-mount terminal blocks; 0.6 x 1 mm pins; straight; Locking lever; Pin spacing 5 mm; 17-pole; gray | <a href="http://www.wago.com/232-147/005-000/039-000">www.wago.com/232-147/005-000/039-000</a> |
|   | <b>Nr. articol: 232-150/005-000</b><br>Female connector for rail-mount terminal blocks; 0.6 x 1 mm pins; straight; Pin spacing 5 mm; 20-pole; gray                        | <a href="http://www.wago.com/232-150/005-000">www.wago.com/232-150/005-000</a>                 |
|  | <b>Nr. articol: 232-150/005-000/039-000</b><br>Female connector for rail-mount terminal blocks; 0.6 x 1 mm pins; straight; Locking lever; Pin spacing 5 mm; 20-pole; gray | <a href="http://www.wago.com/232-150/005-000/039-000">www.wago.com/232-150/005-000/039-000</a> |
|  | <b>Nr. articol: 232-232/005-000</b><br>Female connector for rail-mount terminal blocks; 0.6 x 1 mm pins; angled; Pin spacing 5 mm; 2-pole; gray                           | <a href="http://www.wago.com/232-232/005-000">www.wago.com/232-232/005-000</a>                 |
|  | <b>Nr. articol: 232-232/005-000/039-000</b><br>Female connector for rail-mount terminal blocks; 0.6 x 1 mm pins; angled; Locking lever; Pin spacing 5 mm; 2-pole; gray    | <a href="http://www.wago.com/232-232/005-000/039-000">www.wago.com/232-232/005-000/039-000</a> |
|  | <b>Nr. articol: 232-233/005-000</b><br>Female connector for rail-mount terminal blocks; 0.6 x 1 mm pins; angled; Pin spacing 5 mm; 3-pole; gray                           | <a href="http://www.wago.com/232-233/005-000">www.wago.com/232-233/005-000</a>                 |
|  | <b>Nr. articol: 232-233/005-000/039-000</b><br>Female connector for rail-mount terminal blocks; 0.6 x 1 mm pins; angled; Locking lever; Pin spacing 5 mm; 3-pole; gray    | <a href="http://www.wago.com/232-233/005-000/039-000">www.wago.com/232-233/005-000/039-000</a> |
|  | <b>Nr. articol: 232-234/005-000</b><br>Female connector for rail-mount terminal blocks; 0.6 x 1 mm pins; angled; Pin spacing 5 mm; 4-pole; gray                           | <a href="http://www.wago.com/232-234/005-000">www.wago.com/232-234/005-000</a>                 |
|  | <b>Nr. articol: 232-234/005-000/039-000</b>   |  |

Supus modificărilor.



Female connector for rail-mount terminal blocks; 0.6 x 1 mm pins; angled; Locking lever; Pin spacing 5 mm; 4-pole; gray [www.wago.com/232-234/005-000/039-000](http://www.wago.com/232-234/005-000/039-000)



**Nr. articol: 232-235/005-000**  
Female connector for rail-mount terminal blocks; 0.6 x 1 mm pins; angled; Pin spacing 5 mm; 5-pole; gray [www.wago.com/232-235/005-000](http://www.wago.com/232-235/005-000)



**Nr. articol: 232-235/005-000/039-000**  
Female connector for rail-mount terminal blocks; 0.6 x 1 mm pins; angled; Locking lever; Pin spacing 5 mm; 5-pole; gray [www.wago.com/232-235/005-000/039-000](http://www.wago.com/232-235/005-000/039-000)



**Nr. articol: 232-236/005-000**  
Female connector for rail-mount terminal blocks; 0.6 x 1 mm pins; angled; Pin spacing 5 mm; 6-pole; gray [www.wago.com/232-236/005-000](http://www.wago.com/232-236/005-000)



**Nr. articol: 232-236/005-000/039-000**  
Female connector for rail-mount terminal blocks; 0.6 x 1 mm pins; angled; Locking lever; Pin spacing 5 mm; 6-pole; gray [www.wago.com/232-236/005-000/039-000](http://www.wago.com/232-236/005-000/039-000)



**Nr. articol: 232-237/005-000**  
Female connector for rail-mount terminal blocks; 0.6 x 1 mm pins; angled; Pin spacing 5 mm; 7-pole; gray [www.wago.com/232-237/005-000](http://www.wago.com/232-237/005-000)



**Nr. articol: 232-238/005-000**  
Female connector for rail-mount terminal blocks; 0.6 x 1 mm pins; angled; Pin spacing 5 mm; 8-pole; gray [www.wago.com/232-238/005-000](http://www.wago.com/232-238/005-000)



**Nr. articol: 232-239/005-000**  
Female connector for rail-mount terminal blocks; 0.6 x 1 mm pins; angled; Pin spacing 5 mm; 9-pole; gray [www.wago.com/232-239/005-000](http://www.wago.com/232-239/005-000)



**Nr. articol: 232-240/005-000**  
Female connector for rail-mount terminal blocks; 0.6 x 1 mm pins; angled; Pin spacing 5 mm; 10-pole; gray [www.wago.com/232-240/005-000](http://www.wago.com/232-240/005-000)



**Nr. articol: 232-240/005-000/039-000**  
Female connector for rail-mount terminal blocks; 0.6 x 1 mm pins; angled; Locking lever; Pin spacing 5 mm; 10-pole; gray [www.wago.com/232-240/005-000/039-000](http://www.wago.com/232-240/005-000/039-000)



**Nr. articol: 232-242/005-000**  
Female connector for rail-mount terminal blocks; 0.6 x 1 mm pins; angled; Pin spacing 5 mm; 12-pole; gray [www.wago.com/232-242/005-000](http://www.wago.com/232-242/005-000)















**Nr. articol: 232-242/005-000/039-000**  
Female connector for rail-mount terminal blocks; 0.6 x 1 mm pins; angled; Locking lever; Pin spacing 5 mm; 12-pole; gray [www.wago.com/232-242/005-000/039-000](http://www.wago.com/232-242/005-000/039-000)















**Nr. articol: 232-246/005-000**  
Female connector for rail-mount terminal blocks; 0.6 x 1 mm pins; angled; Pin spacing 5 mm; 16-pole; gray [www.wago.com/232-246/005-000](http://www.wago.com/232-246/005-000)

**Nr. articol: 232-246/005-000/039-000**

Supus modificărilor.

|  |   |  |
|--|---|--|
|    | Female connector for rail-mount terminal blocks; 0.6 x 1 mm pins; angled; Locking lever; Pin spacing 5 mm; 16-pole; gray  | <a href="http://www.wago.com/232-246/005-000/039-000">www.wago.com/232-246/005-000/039-000</a> |
|    | <b>Nr. articol: 232-250/005-000</b><br>Female connector for rail-mount terminal blocks; 0.6 x 1 mm pins; angled; Pin spacing 5 mm; 20-pole; gray                        | <a href="http://www.wago.com/232-250/005-000">www.wago.com/232-250/005-000</a>                 |
|    | <b>Nr. articol: 232-250/005-000/039-000</b><br>Female connector for rail-mount terminal blocks; 0.6 x 1 mm pins; angled; Locking lever; Pin spacing 5 mm; 20-pole; gray | <a href="http://www.wago.com/232-250/005-000/039-000">www.wago.com/232-250/005-000/039-000</a> |
|    | <b>Nr. articol: 232-732/005-000</b><br>THT female header; 0.6 x 1.0 mm solder pin; gray   | <a href="http://www.wago.com/232-732/005-000">www.wago.com/232-732/005-000</a>                 |
|    | <b>Nr. articol: 232-733/005-000</b><br>THT female header; 0.6 x 1.0 mm solder pin; gray   | <a href="http://www.wago.com/232-733/005-000">www.wago.com/232-733/005-000</a>                 |
|    | <b>Nr. articol: 232-734/005-000</b><br>THT female header; 0.6 x 1.0 mm solder pin; gray   | <a href="http://www.wago.com/232-734/005-000">www.wago.com/232-734/005-000</a>                 |
|   | <b>Nr. articol: 232-734/005-000/039-000</b><br>THT female header; 0.6 x 1.0 mm solder pin; gray   | <a href="http://www.wago.com/232-734/005-000/039-000">www.wago.com/232-734/005-000/039-000</a> |
|  | <b>Nr. articol: 232-735/005-000</b><br>THT female header; 0.6 x 1.0 mm solder pin; gray   | <a href="http://www.wago.com/232-735/005-000">www.wago.com/232-735/005-000</a>                 |
|  | <b>Nr. articol: 232-735/005-000/039-000</b><br>THT female header; 0.6 x 1.0 mm solder pin; gray   | <a href="http://www.wago.com/232-735/005-000/039-000">www.wago.com/232-735/005-000/039-000</a> |
|  | <b>Nr. articol: 232-736/005-000</b><br>THT female header; 0.6 x 1.0 mm solder pin; gray   | <a href="http://www.wago.com/232-736/005-000">www.wago.com/232-736/005-000</a>                 |
|  | <b>Nr. articol: 232-736/005-000/039-000</b><br>THT female header; 0.6 x 1.0 mm solder pin; gray   | <a href="http://www.wago.com/232-736/005-000/039-000">www.wago.com/232-736/005-000/039-000</a> |
|  | <b>Nr. articol: 232-738/005-000</b><br>THT female header; 0.6 x 1.0 mm solder pin; gray   | <a href="http://www.wago.com/232-738/005-000">www.wago.com/232-738/005-000</a>                 |
|  | <b>Nr. articol: 232-740/005-000</b><br>THT female header; 0.6 x 1.0 mm solder pin; gray   | <a href="http://www.wago.com/232-740/005-000">www.wago.com/232-740/005-000</a>                 |

Supus modificărilor.

|  |  |  |
|--|--|--|
|    | <b>Nr. articol:</b> 232-742/005-000<br>THT female header; 0.6 x 1.0 mm solder pin; gray  | <a href="http://www.wago.com/232-742/005-000">www.wago.com/232-742/005-000</a>                 |
|    | <b>Nr. articol:</b> 232-832/005-000<br>THT female header; 0.6 x 1.0 mm solder pin; angled; Pin spacing 7.5 mm; 2-pole; gray  | <a href="http://www.wago.com/232-832/005-000">www.wago.com/232-832/005-000</a>                 |
|    | <b>Nr. articol:</b> 232-833/005-000<br>THT female header; 0.6 x 1.0 mm solder pin; angled; Pin spacing 7.5 mm; 3-pole; gray  | <a href="http://www.wago.com/232-833/005-000">www.wago.com/232-833/005-000</a>                 |
|    | <b>Nr. articol:</b> 232-834/005-000<br>THT female header; 0.6 x 1.0 mm solder pin; angled; Pin spacing 7.5 mm; 4-pole; gray  | <a href="http://www.wago.com/232-834/005-000">www.wago.com/232-834/005-000</a>                 |
|    | <b>Nr. articol:</b> 232-836/005-000<br>THT female header; 0.6 x 1.0 mm solder pin; angled; Pin spacing 7.5 mm; 6-pole; gray  | <a href="http://www.wago.com/232-836/005-000">www.wago.com/232-836/005-000</a>                 |
|    | <b>Nr. articol:</b> 232-836/005-000/039-000<br>THT female header; 0.6 x 1.0 mm solder pin; angled; Locking lever; Pin spacing 7.5 mm; 6-pole; gray   | <a href="http://www.wago.com/232-836/005-000/039-000">www.wago.com/232-836/005-000/039-000</a> |
|    | <b>Nr. articol:</b> 232-840/005-000<br>THT female header; 0.6 x 1.0 mm solder pin; angled; Pin spacing 7.5 mm; 10-pole; gray   | <a href="http://www.wago.com/232-840/005-000">www.wago.com/232-840/005-000</a>                 |
|  | <b>Nr. articol:</b> 232-842/005-000<br>THT female header; 0.6 x 1.0 mm solder pin; angled; Pin spacing 7.5 mm; 12-pole; gray   | <a href="http://www.wago.com/232-842/005-000">www.wago.com/232-842/005-000</a>                 |
|  | <b>Nr. articol:</b> 722-132/005-000<br>Female connector for rail-mount terminal blocks; 0.6 x 1 mm pins; straight; 100% protected against mismatching; Pin spacing 5 mm; 2-pole; light gray                        | <a href="http://www.wago.com/722-132/005-000">www.wago.com/722-132/005-000</a>                 |
|  | <b>Nr. articol:</b> 722-132/005-000/039-000<br>Female connector for rail-mount terminal blocks; 0.6 x 1 mm pins; straight; 100% protected against mismatching; Locking lever; Pin spacing 5 mm; 2-pole; light gray | <a href="http://www.wago.com/722-132/005-000/039-000">www.wago.com/722-132/005-000/039-000</a> |
|  | <b>Nr. articol:</b> 722-133/005-000<br>Female connector for rail-mount terminal blocks; 0.6 x 1 mm pins; straight; 100% protected against mismatching; Pin spacing 5 mm; 3-pole; light gray                        | <a href="http://www.wago.com/722-133/005-000">www.wago.com/722-133/005-000</a>                 |
|  | <b>Nr. articol:</b> 722-133/005-000/039-000<br>Female connector for rail-mount terminal blocks; 0.6 x 1 mm pins; straight; 100% protected against mismatching; Locking lever; Pin spacing 5 mm; 3-pole; light gray | <a href="http://www.wago.com/722-133/005-000/039-000">www.wago.com/722-133/005-000/039-000</a> |
|  | <b>Nr. articol:</b> 722-134/005-000<br>Female connector for rail-mount terminal blocks; 0.6 x 1 mm pins; straight; 100% protected against mismatching; Pin spacing 5 mm; 4-pole; light gray                        | <a href="http://www.wago.com/722-134/005-000">www.wago.com/722-134/005-000</a>                 |

**Nr. articol:** 722-134/005-000/039-000

Supus modificărilor.



Female connector for rail-mount terminal blocks; 0.6 x 1 mm pins; straight; 100% protected against mismatching; Locking lever; Pin spacing 5 mm; 4-pole; light gray

[www.wago.com/722-134/005-000/039-000](http://www.wago.com/722-134/005-000/039-000)



**Nr. articol: 722-135/005-000**

Female connector for rail-mount terminal blocks; 0.6 x 1 mm pins; straight; 100% protected against mismatching; Pin spacing 5 mm; 5-pole; light gray

[www.wago.com/722-135/005-000](http://www.wago.com/722-135/005-000)



**Nr. articol: 722-135/005-000/039-000**

Female connector for rail-mount terminal blocks; 0.6 x 1 mm pins; straight; 100% protected against mismatching; Locking lever; Pin spacing 5 mm; 5-pole; light gray

[www.wago.com/722-135/005-000/039-000](http://www.wago.com/722-135/005-000/039-000)



**Nr. articol: 722-136/005-000**

Female connector for rail-mount terminal blocks; 0.6 x 1 mm pins; straight; 100% protected against mismatching; Pin spacing 5 mm; 6-pole; light gray

[www.wago.com/722-136/005-000](http://www.wago.com/722-136/005-000)



**Nr. articol: 722-136/005-000/039-000**

Female connector for rail-mount terminal blocks; 0.6 x 1 mm pins; straight; 100% protected against mismatching; Locking lever; Pin spacing 5 mm; 6-pole; light gray

[www.wago.com/722-136/005-000/039-000](http://www.wago.com/722-136/005-000/039-000)



**Nr. articol: 722-137/005-000**

Female connector for rail-mount terminal blocks; 0.6 x 1 mm pins; straight; 100% protected against mismatching; Pin spacing 5 mm; 7-pole; light gray

[www.wago.com/722-137/005-000](http://www.wago.com/722-137/005-000)



**Nr. articol: 722-137/005-000/039-000**

Female connector for rail-mount terminal blocks; 0.6 x 1 mm pins; straight; 100% protected against mismatching; Locking lever; Pin spacing 5 mm; 7-pole; light gray

[www.wago.com/722-137/005-000/039-000](http://www.wago.com/722-137/005-000/039-000)



**Nr. articol: 722-138/005-000**

Female connector for rail-mount terminal blocks; 0.6 x 1 mm pins; straight; 100% protected against mismatching; Pin spacing 5 mm; 8-pole; light gray

[www.wago.com/722-138/005-000](http://www.wago.com/722-138/005-000)



**Nr. articol: 722-138/005-000/039-000**

Female connector for rail-mount terminal blocks; 0.6 x 1 mm pins; straight; 100% protected against mismatching; Locking lever; Pin spacing 5 mm; 8-pole; light gray

[www.wago.com/722-138/005-000/039-000](http://www.wago.com/722-138/005-000/039-000)



**Nr. articol: 722-139/005-000**

Female connector for rail-mount terminal blocks; 0.6 x 1 mm pins; straight; 100% protected against mismatching; Pin spacing 5 mm; 9-pole; light gray

[www.wago.com/722-139/005-000](http://www.wago.com/722-139/005-000)



**Nr. articol: 722-139/005-000/039-000**

Female connector for rail-mount terminal blocks; 0.6 x 1 mm pins; straight; 100% protected against mismatching; Locking lever; Pin spacing 5 mm; 9-pole; light gray

[www.wago.com/722-139/005-000/039-000](http://www.wago.com/722-139/005-000/039-000)



**Nr. articol: 722-140/005-000**

Female connector for rail-mount terminal blocks; 0.6 x 1 mm pins; straight; 100% protected against mismatching; Pin spacing 5 mm; 10-pole; light gray

[www.wago.com/722-140/005-000](http://www.wago.com/722-140/005-000)



**Nr. articol: 722-140/005-000/039-000**

Female connector for rail-mount terminal blocks; 0.6 x 1 mm pins; straight; 100% protected against mismatching; Locking lever; Pin spacing 5 mm; 10-pole; light gray













[www.wago.com/722-140/005-000/039-000](http://www.wago.com/722-140/005-000/039-000)

**Nr. articol: 722-141/005-000**

Supus modificărilor.

WAGO Kontakttechnik GmbH & Co. KG  
/Representative Office Romania  
Sos. Pipera-Tunari nr. 1/1  
building 1, 2nd floor | 077190 Voluntari, Ilfov  
Tel.: +40-(0)31 421 85 68 | Email: info-RO@wago.com

Aveți întrebări despre produsele noastre?  
Vă stăm la dispoziție pentru preluarea apelului la +40 (0) 31 421 85 68.













|  |   |  |
|--|---|--|
|    | Female connector for rail-mount terminal blocks; 0.6 x 1 mm pins; straight; 100% protected against mismatching; Pin spacing 5 mm; 11-pole; light gray   | <a href="http://www.wago.com/722-141/005-000">www.wago.com/722-141/005-000</a>                 |
|    | <b>Nr. articol: 722-142/005-000</b><br>Female connector for rail-mount terminal blocks; 0.6 x 1 mm pins; straight; 100% protected against mismatching; Pin spacing 5 mm; 12-pole; light gray                        | <a href="http://www.wago.com/722-142/005-000">www.wago.com/722-142/005-000</a>                 |
|    | <b>Nr. articol: 722-142/005-007/039-000</b><br>Female connector for rail-mount terminal blocks; gray  | <a href="http://www.wago.com/722-142/005-007/039-000">www.wago.com/722-142/005-007/039-000</a> |
|    | <b>Nr. articol: 722-143/005-000</b><br>Female connector for rail-mount terminal blocks; 0.6 x 1 mm pins; straight; 100% protected against mismatching; Pin spacing 5 mm; 13-pole; light gray                        | <a href="http://www.wago.com/722-143/005-000">www.wago.com/722-143/005-000</a>                 |
|    | <b>Nr. articol: 722-144/005-000</b><br>Female connector for rail-mount terminal blocks; 0.6 x 1 mm pins; straight; 100% protected against mismatching; Pin spacing 5 mm; 14-pole; light gray                        | <a href="http://www.wago.com/722-144/005-000">www.wago.com/722-144/005-000</a>                 |
|    | <b>Nr. articol: 722-144/005-000/039-000</b><br>Female connector for rail-mount terminal blocks; 0.6 x 1 mm pins; straight; 100% protected against mismatching; Locking lever; Pin spacing 5 mm; 14-pole; light gray | <a href="http://www.wago.com/722-144/005-000/039-000">www.wago.com/722-144/005-000/039-000</a> |
|    | <b>Nr. articol: 722-145/005-000</b><br>Female connector for rail-mount terminal blocks; 0.6 x 1 mm pins; straight; 100% protected against mismatching; Pin spacing 5 mm; 15-pole; light gray                        | <a href="http://www.wago.com/722-145/005-000">www.wago.com/722-145/005-000</a>                 |
|   | <b>Nr. articol: 722-146/005-000</b><br>Female connector for rail-mount terminal blocks; 0.6 x 1 mm pins; straight; 100% protected against mismatching; Pin spacing 5 mm; 16-pole; light gray                        | <a href="http://www.wago.com/722-146/005-000">www.wago.com/722-146/005-000</a>                 |
|  | <b>Nr. articol: 722-146/005-000/039-000</b><br>Female connector for rail-mount terminal blocks; 0.6 x 1 mm pins; straight; 100% protected against mismatching; Locking lever; Pin spacing 5 mm; 16-pole; light gray | <a href="http://www.wago.com/722-146/005-000/039-000">www.wago.com/722-146/005-000/039-000</a> |
|  | <b>Nr. articol: 722-150/005-000</b><br>Female connector for rail-mount terminal blocks; 0.6 x 1 mm pins; straight; 100% protected against mismatching; Pin spacing 5 mm; 20-pole; light gray                        | <a href="http://www.wago.com/722-150/005-000">www.wago.com/722-150/005-000</a>                 |
|  | <b>Nr. articol: 722-150/005-000/039-000</b><br>Female connector for rail-mount terminal blocks; 0.6 x 1 mm pins; straight; 100% protected against mismatching; Locking lever; Pin spacing 5 mm; 20-pole; light gray | <a href="http://www.wago.com/722-150/005-000/039-000">www.wago.com/722-150/005-000/039-000</a> |
|  | <b>Nr. articol: 722-232/005-000</b><br>Female connector for rail-mount terminal blocks; 0.6 x 1 mm pins; angled; 100% protected against mismatching; Pin spacing 5 mm; 2-pole; light gray                           | <a href="http://www.wago.com/722-232/005-000">www.wago.com/722-232/005-000</a>                 |
|  | <b>Nr. articol: 722-232/005-000/039-000</b><br>Female connector for rail-mount terminal blocks; 0.6 x 1 mm pins; angled; 100% protected against mismatching; Locking lever; Pin spacing 5 mm; 2-pole; light gray    | <a href="http://www.wago.com/722-232/005-000/039-000">www.wago.com/722-232/005-000/039-000</a> |

**Nr. articol: 722-233/005-000**

Supus modificărilor.

WAGO Kontakttechnik GmbH & Co. KG  
/Representative Office Romania  
Sos. Pipera-Tunari nr. 1/1  
building 1, 2nd floor | 077190 Voluntari, Ilfov  
Tel.: +40-(0)31 421 85 68 | Email: info-RO@wago.com















Aveți întrebări despre produsele noastre?  
Vă stăm la dispoziție pentru preluarea apelului la +40 (0) 31 421 85 68.

|  |  |  |
|--|--|--|
|    | Female connector for rail-mount terminal blocks; 0.6 x 1 mm pins; angled; 100% protected against mismatching; Pin spacing 5 mm; 3-pole; light gray   | <a href="http://www.wago.com/722-233/005-000">www.wago.com/722-233/005-000</a>                 |
|    | <b>Nr. articol: 722-233/005-000/039-000</b><br>Female connector for rail-mount terminal blocks; 0.6 x 1 mm pins; angled; 100% protected against mismatching; Locking lever; Pin spacing 5 mm; 3-pole; light gray | <a href="http://www.wago.com/722-233/005-000/039-000">www.wago.com/722-233/005-000/039-000</a> |
|    | <b>Nr. articol: 722-234/005-000</b><br>Female connector for rail-mount terminal blocks; 0.6 x 1 mm pins; angled; 100% protected against mismatching; Pin spacing 5 mm; 4-pole; light gray                        | <a href="http://www.wago.com/722-234/005-000">www.wago.com/722-234/005-000</a>                 |
|    | <b>Nr. articol: 722-234/005-000/039-000</b><br>Female connector for rail-mount terminal blocks; 0.6 x 1 mm pins; angled; 100% protected against mismatching; Locking lever; Pin spacing 5 mm; 4-pole; light gray | <a href="http://www.wago.com/722-234/005-000/039-000">www.wago.com/722-234/005-000/039-000</a> |
|    | <b>Nr. articol: 722-235/005-000</b><br>Female connector for rail-mount terminal blocks; 0.6 x 1 mm pins; angled; 100% protected against mismatching; Pin spacing 5 mm; 5-pole; light gray                        | <a href="http://www.wago.com/722-235/005-000">www.wago.com/722-235/005-000</a>                 |
|    | <b>Nr. articol: 722-235/005-000/039-000</b><br>Female connector for rail-mount terminal blocks; 0.6 x 1 mm pins; angled; 100% protected against mismatching; Locking lever; Pin spacing 5 mm; 5-pole; light gray | <a href="http://www.wago.com/722-235/005-000/039-000">www.wago.com/722-235/005-000/039-000</a> |
|   | <b>Nr. articol: 722-236/005-000</b><br>Female connector for rail-mount terminal blocks; 0.6 x 1 mm pins; angled; 100% protected against mismatching; Pin spacing 5 mm; 6-pole; light gray                        | <a href="http://www.wago.com/722-236/005-000">www.wago.com/722-236/005-000</a>                 |
|  | <b>Nr. articol: 722-236/005-000/039-000</b><br>Female connector for rail-mount terminal blocks; 0.6 x 1 mm pins; angled; 100% protected against mismatching; Locking lever; Pin spacing 5 mm; 6-pole; light gray | <a href="http://www.wago.com/722-236/005-000/039-000">www.wago.com/722-236/005-000/039-000</a> |
|  | <b>Nr. articol: 722-237/005-000</b><br>Female connector for rail-mount terminal blocks; 0.6 x 1 mm pins; angled; 100% protected against mismatching; Pin spacing 5 mm; 7-pole; light gray                        | <a href="http://www.wago.com/722-237/005-000">www.wago.com/722-237/005-000</a>                 |
|  | <b>Nr. articol: 722-237/005-000/039-000</b><br>Female connector for rail-mount terminal blocks; 0.6 x 1 mm pins; angled; 100% protected against mismatching; Locking lever; Pin spacing 5 mm; 7-pole; light gray | <a href="http://www.wago.com/722-237/005-000/039-000">www.wago.com/722-237/005-000/039-000</a> |
|  | <b>Nr. articol: 722-238/005-000</b><br>Female connector for rail-mount terminal blocks; 0.6 x 1 mm pins; angled; 100% protected against mismatching; Pin spacing 5 mm; 8-pole; light gray                        | <a href="http://www.wago.com/722-238/005-000">www.wago.com/722-238/005-000</a>                 |
|  | <b>Nr. articol: 722-239/005-000</b><br>Female connector for rail-mount terminal blocks; 0.6 x 1 mm pins; angled; 100% protected against mismatching; Pin spacing 5 mm; 9-pole; light gray                        | <a href="http://www.wago.com/722-239/005-000">www.wago.com/722-239/005-000</a>                 |
|  | <b>Nr. articol: 722-239/005-000/039-000</b><br>Female connector for rail-mount terminal blocks; 0.6 x 1 mm pins; angled; 100% protected against mismatching; Locking lever; Pin spacing 5 mm; 9-pole; light gray | <a href="http://www.wago.com/722-239/005-000/039-000">www.wago.com/722-239/005-000/039-000</a> |
|  | <b>Nr. articol: 722-240/005-000</b>  |  |

Supus modificărilor.

WAGO Kontakttechnik GmbH & Co. KG  
 /Representative Office Romania  
 Sos. Pipera-Tunari nr. 1/1  
 building 1, 2nd floor | 077190 Voluntari, Ilfov  
 Tel.: +40-(0)31 421 85 68 | Email: info-RO@wago.com

Aveți întrebări despre produsele noastre?  
 Vă stăm la dispoziție pentru preluarea apelului la +40 (0) 31 421 85 68.

















|  |   |  |
|--|---|--|
|    | Female connector for rail-mount terminal blocks; 0.6 x 1 mm pins; angled; 100% protected against mismatching; Pin spacing 5 mm; 10-pole; light gray   | <a href="http://www.wago.com/722-240/005-000">www.wago.com/722-240/005-000</a>                 |
|    | <b>Nr. articol: 722-240/005-000/039-000</b><br>Female connector for rail-mount terminal blocks; 0.6 x 1 mm pins; angled; 100% protected against mismatching; Locking lever; Pin spacing 5 mm; 10-pole; light gray | <a href="http://www.wago.com/722-240/005-000/039-000">www.wago.com/722-240/005-000/039-000</a> |
|    | <b>Nr. articol: 722-241/005-000</b><br>Female connector for rail-mount terminal blocks; 0.6 x 1 mm pins; angled; 100% protected against mismatching; Pin spacing 5 mm; 11-pole; light gray                        | <a href="http://www.wago.com/722-241/005-000">www.wago.com/722-241/005-000</a>                 |
|    | <b>Nr. articol: 722-242/005-000</b><br>Female connector for rail-mount terminal blocks; 0.6 x 1 mm pins; angled; 100% protected against mismatching; Pin spacing 5 mm; 12-pole; light gray                        | <a href="http://www.wago.com/722-242/005-000">www.wago.com/722-242/005-000</a>                 |
|    | <b>Nr. articol: 722-242/005-000/039-000</b><br>Female connector for rail-mount terminal blocks; 0.6 x 1 mm pins; angled; 100% protected against mismatching; Locking lever; Pin spacing 5 mm; 12-pole; light gray | <a href="http://www.wago.com/722-242/005-000/039-000">www.wago.com/722-242/005-000/039-000</a> |
|    | <b>Nr. articol: 722-243/005-000</b><br>Female connector for rail-mount terminal blocks; 0.6 x 1 mm pins; angled; 100% protected against mismatching; Pin spacing 5 mm; 13-pole; light gray                        | <a href="http://www.wago.com/722-243/005-000">www.wago.com/722-243/005-000</a>                 |
|    | <b>Nr. articol: 722-244/005-000</b><br>Female connector for rail-mount terminal blocks; 0.6 x 1 mm pins; angled; 100% protected against mismatching; Pin spacing 5 mm; 14-pole; light gray                        | <a href="http://www.wago.com/722-244/005-000">www.wago.com/722-244/005-000</a>                 |
|  | <b>Nr. articol: 722-244/005-000/039-000</b><br>Female connector for rail-mount terminal blocks; 0.6 x 1 mm pins; angled; 100% protected against mismatching; Locking lever; Pin spacing 5 mm; 14-pole; light gray | <a href="http://www.wago.com/722-244/005-000/039-000">www.wago.com/722-244/005-000/039-000</a> |
|  | <b>Nr. articol: 722-246/005-000</b><br>Female connector for rail-mount terminal blocks; 0.6 x 1 mm pins; angled; 100% protected against mismatching; Pin spacing 5 mm; 16-pole; light gray                        | <a href="http://www.wago.com/722-246/005-000">www.wago.com/722-246/005-000</a>                 |
|  | <b>Nr. articol: 722-246/005-000/039-000</b><br>Female connector for rail-mount terminal blocks; 0.6 x 1 mm pins; angled; 100% protected against mismatching; Locking lever; Pin spacing 5 mm; 16-pole; light gray | <a href="http://www.wago.com/722-246/005-000/039-000">www.wago.com/722-246/005-000/039-000</a> |
|  | <b>Nr. articol: 722-250/005-000</b><br>Female connector for rail-mount terminal blocks; 0.6 x 1 mm pins; angled; 100% protected against mismatching; Pin spacing 5 mm; 20-pole; light gray                        | <a href="http://www.wago.com/722-250/005-000">www.wago.com/722-250/005-000</a>                 |
| <b>Carrier rail</b>  |   |  |
|  | <b>Nr. articol: 210-112</b><br>Steel carrier rail; 35 x 7.5 mm; 1 mm thick; 2 m long; slotted; according to EN 60715; "Hole width 25 mm   | <a href="http://www.wago.com/210-112">www.wago.com/210-112</a>                                 |
|  | <b>Nr. articol: 210-113</b><br>Steel carrier rail; 35 x 7.5 mm; 1 mm thick; 2 m long; unslotted; according to EN 60715  | <a href="http://www.wago.com/210-113">www.wago.com/210-113</a>                                 |
|  | <b>Nr. articol: 210-114</b><br>Steel carrier rail; 35 x 15 mm; 1.5 mm thick; 2 m long; unslotted; similar to EN 60715   | <a href="http://www.wago.com/210-114">www.wago.com/210-114</a>                                 |

Supus modificărilor.

WAGO Kontakttechnik GmbH & Co. KG  
 /Representative Office Romania  
 Sos. Pipera-Tunari nr. 1/1  
 building 1, 2nd floor | 077190 Voluntari, Ilfov  
 Tel.: +40-(0)31 421 85 68 | Email: info-RO@wago.com

Aveți întrebări despre produsele noastre?  
 Vă stăm la dispoziție pentru preluarea apelului la +40 (0) 31 421 85 68.



|   |   |  |
|---|---|--|
|   | <b>Nr. articol: 210-115</b><br>Steel carrier rail; 35 x 7.5 mm; 1 mm thick; 2 m long; slotted; according to EN 60715; "Hole width 18 mm   | <a href="http://www.wago.com/210-115">www.wago.com/210-115</a> |
|   | <b>Nr. articol: 210-118</b><br>Steel carrier rail; 35 x 15 mm; 2.3 mm thick; 2 m long; unslotted; according to EN 60715                   | <a href="http://www.wago.com/210-118">www.wago.com/210-118</a> |
|   | <b>Nr. articol: 210-196</b><br>Aluminum carrier rail; 35 x 8.2 mm; 1.6 mm thick; 2 m long; unslotted; similar to EN 60715; silver-colored | <a href="http://www.wago.com/210-196">www.wago.com/210-196</a> |
|   | <b>Nr. articol: 210-197</b><br>Steel carrier rail; 35 x 15 mm; 1.5 mm thick; 2 m long; slotted; similar to EN 60715                       | <a href="http://www.wago.com/210-197">www.wago.com/210-197</a> |
|   | <b>Nr. articol: 210-198</b><br>Copper carrier rail; 35 x 15 mm; 2.3 mm thick; 2 m long; unslotted; according to EN 60715; copper-colored  | <a href="http://www.wago.com/210-198">www.wago.com/210-198</a> |
|   | <b>Nr. articol: 210-504</b><br>Steel carrier rail; 35 x 7.5 mm; 1 mm thick; 2 m long; slotted; galvanized; according to EN 60715          | <a href="http://www.wago.com/210-504">www.wago.com/210-504</a> |
|   | <b>Nr. articol: 210-505</b><br>Steel carrier rail; 35 x 7.5 mm; 1 mm thick; 2 m long; unslotted; galvanized; according to EN 60715        | <a href="http://www.wago.com/210-505">www.wago.com/210-505</a> |
|   | <b>Nr. articol: 210-506</b><br>Steel carrier rail; 35 x 15 mm; 1.5 mm thick; 2 m long; unslotted; galvanized; similar to EN 60715         | <a href="http://www.wago.com/210-506">www.wago.com/210-506</a> |
|  | <b>Nr. articol: 210-508</b><br>Steel carrier rail; 35 x 15 mm; 1.5 mm thick; 2 m long; slotted; galvanized; similar to EN 60715           | <a href="http://www.wago.com/210-508">www.wago.com/210-508</a> |
| <b>ferrule</b>  |   |  |
|  | <b>Nr. articol: 216-101</b><br>Ferrule; Sleeve for 0.5 mm <sup>2</sup> / AWG 22; uninsulated; electro-tin plated                          | <a href="http://www.wago.com/216-101">www.wago.com/216-101</a> |
|  | <b>Nr. articol: 216-102</b><br>Ferrule; Sleeve for 0.75 mm <sup>2</sup> / AWG 20; uninsulated; electro-tin plated                         | <a href="http://www.wago.com/216-102">www.wago.com/216-102</a> |
|  | <b>Nr. articol: 216-103</b><br>Ferrule; Sleeve for 1 mm <sup>2</sup> / AWG 18; uninsulated; electro-tin plated                            | <a href="http://www.wago.com/216-103">www.wago.com/216-103</a> |
|  | <b>Nr. articol: 216-104</b><br>Ferrule; Sleeve for 1.5 mm <sup>2</sup> / AWG 16; uninsulated; electro-tin plated                          | <a href="http://www.wago.com/216-104">www.wago.com/216-104</a> |
|  | <b>Nr. articol: 216-201</b><br>Ferrule; Sleeve for 0.5 mm <sup>2</sup> / 20 AWG; insulated; electro-tin plated; white                     | <a href="http://www.wago.com/216-201">www.wago.com/216-201</a> |
|  | <b>Nr. articol: 216-202</b><br>Ferrule; Sleeve for 0.75 mm <sup>2</sup> / 18 AWG; insulated; electro-tin plated; gray                     | <a href="http://www.wago.com/216-202">www.wago.com/216-202</a> |
|  | <b>Nr. articol: 216-203</b><br>Ferrule; Sleeve for 1 mm <sup>2</sup> / AWG 18; insulated; electro-tin plated; red                         | <a href="http://www.wago.com/216-203">www.wago.com/216-203</a> |
|  | <b>Nr. articol: 216-204</b><br>Ferrule; Sleeve for 1.5 mm <sup>2</sup> / AWG 16; insulated; electro-tin plated; black                     | <a href="http://www.wago.com/216-204">www.wago.com/216-204</a> |

Supus modificărilor.

**Nr. articol: 216-301**Ferrule; Sleeve for 0.25 mm<sup>2</sup> / AWG 24; insulated; electro-tin plated; yellow[www.wago.com/216-301](http://www.wago.com/216-301)**Nr. articol: 216-302**Ferrule; Sleeve for 0.34 mm<sup>2</sup> / 22 AWG; insulated; electro-tin plated; green[www.wago.com/216-302](http://www.wago.com/216-302)**Protective Warning Marker****Nr. articol: 280-415**

Protective warning marker; with high-voltage symbol, black; for 5 terminal blocks; yellow

[www.wago.com/280-415](http://www.wago.com/280-415)**General accessories****Nr. articol: 231-162/003-000**

Male connector for rail-mount terminal blocks; 1.2 x 1.2 mm pins; straight; Pin spacing 5 mm; 2-pole; gray

[www.wago.com/231-162/003-000](http://www.wago.com/231-162/003-000)**Nr. articol: 231-163/003-000**

Male connector for rail-mount terminal blocks; 1.2 x 1.2 mm pins; straight; Pin spacing 5 mm; 3-pole; gray

[www.wago.com/231-163/003-000](http://www.wago.com/231-163/003-000)**Nr. articol: 231-164/003-000**

Male connector for rail-mount terminal blocks; 1.2 x 1.2 mm pins; straight; Pin spacing 5 mm; 4-pole; gray

[www.wago.com/231-164/003-000](http://www.wago.com/231-164/003-000)**Nr. articol: 231-165/003-000**

Male connector for rail-mount terminal blocks; 1.2 x 1.2 mm pins; straight; Pin spacing 5 mm; 5-pole; gray

[www.wago.com/231-165/003-000](http://www.wago.com/231-165/003-000)**Nr. articol: 231-166/003-000**

Male connector for rail-mount terminal blocks; 1.2 x 1.2 mm pins; straight; Pin spacing 5 mm; 6-pole; gray

[www.wago.com/231-166/003-000](http://www.wago.com/231-166/003-000)**Nr. articol: 231-167/003-000**

Male connector for rail-mount terminal blocks; 1.2 x 1.2 mm pins; straight; Pin spacing 5 mm; 7-pole; gray

[www.wago.com/231-167/003-000](http://www.wago.com/231-167/003-000)**Nr. articol: 231-168/003-000**

Male connector for rail-mount terminal blocks; 1.2 x 1.2 mm pins; straight; Pin spacing 5 mm; 8-pole; gray

[www.wago.com/231-168/003-000](http://www.wago.com/231-168/003-000)**Nr. articol: 231-169/003-000**

Male connector for rail-mount terminal blocks; 1.2 x 1.2 mm pins; straight; Pin spacing 5 mm; 9-pole; gray

[www.wago.com/231-169/003-000](http://www.wago.com/231-169/003-000)**Nr. articol: 231-170/003-000**

Male connector for rail-mount terminal blocks; 1.2 x 1.2 mm pins; straight; Pin spacing 5 mm; 10-pole; gray















[www.wago.com/231-170/003-000](http://www.wago.com/231-170/003-000)**Nr. articol: 231-171/003-000**

Male connector for rail-mount terminal blocks; 1.2 x 1.2 mm pins; straight; Pin spacing 5 mm; 11-pole; gray

[www.wago.com/231-171/003-000](http://www.wago.com/231-171/003-000)**Nr. articol: 231-172/003-000**

Male connector for rail-mount terminal blocks; 1.2 x 1.2 mm pins; straight; Pin spacing 5 mm; 12-pole;

Supus modificărilor.

|  |  |  |
|--|--|--|
|    | gray   | <a href="http://www.wago.com/231-172/003-000">www.wago.com/231-172/003-000</a> |
|    | <b>Nr. articol: 231-176/003-000</b><br>Male connector for rail-mount terminal blocks; 1.2 x 1.2 mm pins; straight; Pin spacing 5 mm; 16-pole; gray   | <a href="http://www.wago.com/231-176/003-000">www.wago.com/231-176/003-000</a> |
|    | <b>Nr. articol: 231-180/003-000</b><br>Male connector for rail-mount terminal blocks; 1.2 x 1.2 mm pins; straight; Pin spacing 5 mm; 20-pole; gray   | <a href="http://www.wago.com/231-180/003-000">www.wago.com/231-180/003-000</a> |
|    | <b>Nr. articol: 231-668</b><br>Lockout caps; for covering unused clamping units; gray  | <a href="http://www.wago.com/231-668">www.wago.com/231-668</a>                 |
|    | <b>Nr. articol: 231-669</b><br>Lockout caps; for covering unused clamping units; orange  | <a href="http://www.wago.com/231-669">www.wago.com/231-669</a>                 |
|    | <b>Nr. articol: 721-162/003-000</b><br>Male connector for rail-mount terminal blocks; 1.2 x 1.2 mm pins; straight; 100% protected against mismatching; Pin spacing 5 mm; 2-pole; light gray  | <a href="http://www.wago.com/721-162/003-000">www.wago.com/721-162/003-000</a> |
|    | <b>Nr. articol: 721-163/003-000</b><br>Male connector for rail-mount terminal blocks; 1.2 x 1.2 mm pins; straight; 100% protected against mismatching; Pin spacing 5 mm; 3-pole; light gray  | <a href="http://www.wago.com/721-163/003-000">www.wago.com/721-163/003-000</a> |
|  | <b>Nr. articol: 721-164/003-000</b><br>Male connector for rail-mount terminal blocks; 1.2 x 1.2 mm pins; straight; 100% protected against mismatching; Pin spacing 5 mm; 4-pole; light gray  | <a href="http://www.wago.com/721-164/003-000">www.wago.com/721-164/003-000</a> |
|  | <b>Nr. articol: 721-165/003-000</b><br>Male connector for rail-mount terminal blocks; 1.2 x 1.2 mm pins; straight; 100% protected against mismatching; Pin spacing 5 mm; 5-pole; light gray  | <a href="http://www.wago.com/721-165/003-000">www.wago.com/721-165/003-000</a> |
|  | <b>Nr. articol: 721-166/003-000</b><br>Male connector for rail-mount terminal blocks; 1.2 x 1.2 mm pins; straight; 100% protected against mismatching; Pin spacing 5 mm; 6-pole; light gray  | <a href="http://www.wago.com/721-166/003-000">www.wago.com/721-166/003-000</a> |
|  | <b>Nr. articol: 721-167/003-000</b><br>Male connector for rail-mount terminal blocks; 1.2 x 1.2 mm pins; straight; 100% protected against mismatching; Pin spacing 5 mm; 7-pole; light gray  | <a href="http://www.wago.com/721-167/003-000">www.wago.com/721-167/003-000</a> |
|  | <b>Nr. articol: 721-168/003-000</b><br>Male connector for rail-mount terminal blocks; 1.2 x 1.2 mm pins; straight; 100% protected against mismatching; Pin spacing 5 mm; 8-pole; light gray  | <a href="http://www.wago.com/721-168/003-000">www.wago.com/721-168/003-000</a> |
|  | <b>Nr. articol: 721-169/003-000</b><br>Male connector for rail-mount terminal blocks; 1.2 x 1.2 mm pins; straight; 100% protected against mismatching; Pin spacing 5 mm; 9-pole; light gray  | <a href="http://www.wago.com/721-169/003-000">www.wago.com/721-169/003-000</a> |
|  | <b>Nr. articol: 721-170/003-000</b><br>Male connector for rail-mount terminal blocks; 1.2 x 1.2 mm pins; straight; 100% protected against mismatching; Pin spacing 5 mm; 10-pole; light gray | <a href="http://www.wago.com/721-170/003-000">www.wago.com/721-170/003-000</a> |

Supus modificărilor.

WAGO Kontakttechnik GmbH & Co. KG  
 /Representative Office Romania  
 Sos. Pipera-Tunari nr. 1/1  
 building 1, 2nd floor | 077190 Voluntari, Ilfov  
 Tel.: +40-(0)31 421 85 68 | Email: info-RO@wago.com

Aveți întrebări despre produsele noastre?  
 Vă stăm la dispoziție pentru preluarea apelului la +40 (0) 31 421 85 68.

**Nr. articol: 721-171/003-000**

Male connector for rail-mount terminal blocks; 1.2 x 1.2 mm pins; straight; 100% protected against mismatching; Pin spacing 5 mm; 11-pole; light gray

[www.wago.com/721-171/003-000](http://www.wago.com/721-171/003-000)**Nr. articol: 721-172/003-000**

Male connector for rail-mount terminal blocks; 1.2 x 1.2 mm pins; straight; 100% protected against mismatching; Pin spacing 5 mm; 12-pole; light gray

[www.wago.com/721-172/003-000](http://www.wago.com/721-172/003-000)**Nr. articol: 721-173/003-000**

Male connector for rail-mount terminal blocks; 1.2 x 1.2 mm pins; straight; 100% protected against mismatching; Pin spacing 5 mm; 13-pole; light gray

[www.wago.com/721-173/003-000](http://www.wago.com/721-173/003-000)**Nr. articol: 721-174/003-000**

Male connector for rail-mount terminal blocks; 1.2 x 1.2 mm pins; straight; 100% protected against mismatching; Pin spacing 5 mm; 14-pole; light gray

[www.wago.com/721-174/003-000](http://www.wago.com/721-174/003-000)**Nr. articol: 721-175/003-000**

Male connector for rail-mount terminal blocks; 1.2 x 1.2 mm pins; straight; 100% protected against mismatching; Pin spacing 5 mm; 15-pole; light gray

[www.wago.com/721-175/003-000](http://www.wago.com/721-175/003-000)**Nr. articol: 721-176/003-000**

Male connector for rail-mount terminal blocks; 1.2 x 1.2 mm pins; straight; 100% protected against mismatching; Pin spacing 5 mm; 16-pole; light gray

[www.wago.com/721-176/003-000](http://www.wago.com/721-176/003-000)**Nr. articol: 721-180/003-000**

Male connector for rail-mount terminal blocks; 1.2 x 1.2 mm pins; straight; 100% protected against mismatching; Pin spacing 5 mm; 20-pole; light gray

[www.wago.com/721-180/003-000](http://www.wago.com/721-180/003-000)**Marking accessories****Nr. articol: 2009-115**

WMB-Inline; for Smart Printer; 1500 pieces on roll; stretchable 5 - 5.2 mm; plain; snap-on type; white

[www.wago.com/2009-115](http://www.wago.com/2009-115)**Nr. articol: 2009-115/000-002**

WMB-Inline; for Smart Printer; 1500 pieces on roll; stretchable 5 - 5.2 mm; plain; snap-on type; yellow

[www.wago.com/2009-115/000-002](http://www.wago.com/2009-115/000-002)**Nr. articol: 2009-115/000-006**

WMB-Inline; for Smart Printer; 1500 pieces on roll; stretchable 5 - 5.2 mm; plain; snap-on type; blue

[www.wago.com/2009-115/000-006](http://www.wago.com/2009-115/000-006)**Nr. articol: 2009-115/000-007**

WMB-Inline; for Smart Printer; 1500 pieces on roll; stretchable 5 - 5.2 mm; plain; snap-on type; gray

[www.wago.com/2009-115/000-007](http://www.wago.com/2009-115/000-007)**Nr. articol: 2009-115/000-012**

















WMB-Inline; for Smart Printer; 1500 pieces on roll; stretchable 5 - 5.2 mm; plain; snap-on type; orange

[www.wago.com/2009-115/000-012](http://www.wago.com/2009-115/000-012)**Nr. articol: 2009-115/000-017**

WMB-Inline; for Smart Printer; 1500 pieces on roll; stretchable 5 - 5.2 mm; plain; snap-on type; light green

[www.wago.com/2009-115/000-017](http://www.wago.com/2009-115/000-017)















Supus modificărilor.

|  |   |  |
|--|---|--|
|    | <b>Nr. articol: 2009-115/000-023</b><br>WMB-Inline; for Smart Printer; 1500 pieces on roll; stretchable 5 - 5.2 mm; plain; snap-on type; green  | <a href="http://www.wago.com/2009-115/000-023">www.wago.com/2009-115/000-023</a> |
|    | <b>Nr. articol: 2009-115/000-024</b><br>WMB-Inline; for Smart Printer; 1500 pieces on roll; stretchable 5 - 5.2 mm; plain; snap-on type; violet | <a href="http://www.wago.com/2009-115/000-024">www.wago.com/2009-115/000-024</a> |
|    | <b>Nr. articol: 209-128</b><br>Adaptor; gray  | <a href="http://www.wago.com/209-128">www.wago.com/209-128</a>                   |
|    | <b>Nr. articol: 209-140</b><br>Group marker carrier; gray   | <a href="http://www.wago.com/209-140">www.wago.com/209-140</a>                   |
|    | <b>Nr. articol: 209-141</b><br>Group marker carrier; gray   | <a href="http://www.wago.com/209-141">www.wago.com/209-141</a>                   |
|    | <b>Nr. articol: 209-142</b><br>Group marker carrier; gray   | <a href="http://www.wago.com/209-142">www.wago.com/209-142</a>                   |
|    | <b>Nr. articol: 209-185</b><br>Adaptor; gray  | <a href="http://www.wago.com/209-185">www.wago.com/209-185</a>                   |
|    | <b>Nr. articol: 210-612</b><br>Marking strips; for self-marking; plain; Self-adhesive; transparent  | <a href="http://www.wago.com/210-612">www.wago.com/210-612</a>                   |
|   | <b>Nr. articol: 249-105</b><br>Group marker carrier; gray   | <a href="http://www.wago.com/249-105">www.wago.com/249-105</a>                   |
|  | <b>Nr. articol: 793-501</b><br>WMB marking card; as card; not stretchable; plain; snap-on type; white   | <a href="http://www.wago.com/793-501">www.wago.com/793-501</a>                   |
|  | <b>Nr. articol: 793-501/000-002</b><br>WMB marking card; as card; not stretchable; plain; snap-on type; yellow                                  | <a href="http://www.wago.com/793-501/000-002">www.wago.com/793-501/000-002</a>   |
|  | <b>Nr. articol: 793-501/000-005</b><br>WMB marking card; as card; not stretchable; plain; snap-on type; red                                     | <a href="http://www.wago.com/793-501/000-005">www.wago.com/793-501/000-005</a>   |
|  | <b>Nr. articol: 793-501/000-006</b><br>WMB marking card; as card; not stretchable; plain; snap-on type; blue                                    | <a href="http://www.wago.com/793-501/000-006">www.wago.com/793-501/000-006</a>   |
|  | <b>Nr. articol: 793-501/000-007</b><br>WMB marking card; as card; not stretchable; plain; snap-on type; gray                                    | <a href="http://www.wago.com/793-501/000-007">www.wago.com/793-501/000-007</a>   |
|  | <b>Nr. articol: 793-501/000-012</b><br>WMB marking card; as card; not stretchable; plain; snap-on type; orange                                  | <a href="http://www.wago.com/793-501/000-012">www.wago.com/793-501/000-012</a>   |
|  | <b>Nr. articol: 793-501/000-017</b><br>WMB marking card; as card; not stretchable; plain; snap-on type; light green                             | <a href="http://www.wago.com/793-501/000-017">www.wago.com/793-501/000-017</a>   |



Supus modificărilor.

WAGO Kontakttechnik GmbH & Co. KG  
/Representative Office Romania  
Sos. Pipera-Tunari nr. 1/1  
building 1, 2nd floor | 077190 Voluntari, Ilfov  
Tel.: +40-(0)31 421 85 68 | Email: info-RO@wago.com

Aveți întrebări despre produsele noastre?  
Vă stăm la dispoziție pentru preluarea apelului la +40 (0) 31 421 85 68.

|  |   |  |
|--|---|--|
|    | <b>Nr. articol: 793-501/000-023</b><br>WMB marking card; as card; not stretchable; plain; snap-on type; green   | <a href="http://www.wago.com/793-501/000-023">www.wago.com/793-501/000-023</a>   |
|    | <b>Nr. articol: 793-501/000-024</b><br>WMB marking card; as card; not stretchable; plain; snap-on type; violet  | <a href="http://www.wago.com/793-501/000-024">www.wago.com/793-501/000-024</a>   |
|    | <b>Nr. articol: 793-5501</b><br>WMB marking card; as card; for terminal block width 5 - 17.5 mm; stretchable 5 - 5.2 mm; plain; snap-on type; white               | <a href="http://www.wago.com/793-5501">www.wago.com/793-5501</a>                 |
|    | <b>Nr. articol: 793-5501/000-002</b><br>WMB marking card; as card; for terminal block width 5 - 17.5 mm; stretchable 5 - 5.2 mm; plain; snap-on type; yellow      | <a href="http://www.wago.com/793-5501/000-002">www.wago.com/793-5501/000-002</a> |
|    | <b>Nr. articol: 793-5501/000-005</b><br>WMB marking card; as card; for terminal block width 5 - 17.5 mm; stretchable 5 - 5.2 mm; plain; snap-on type; red         | <a href="http://www.wago.com/793-5501/000-005">www.wago.com/793-5501/000-005</a> |
|    | <b>Nr. articol: 793-5501/000-006</b><br>WMB marking card; as card; for terminal block width 5 - 17.5 mm; stretchable 5 - 5.2 mm; plain; snap-on type; blue        | <a href="http://www.wago.com/793-5501/000-006">www.wago.com/793-5501/000-006</a> |
|   | <b>Nr. articol: 793-5501/000-007</b><br>WMB marking card; as card; for terminal block width 5 - 17.5 mm; stretchable 5 - 5.2 mm; plain; snap-on type; gray        | <a href="http://www.wago.com/793-5501/000-007">www.wago.com/793-5501/000-007</a> |
|  | <b>Nr. articol: 793-5501/000-012</b><br>WMB marking card; as card; for terminal block width 5 - 17.5 mm; stretchable 5 - 5.2 mm; plain; snap-on type; orange      | <a href="http://www.wago.com/793-5501/000-012">www.wago.com/793-5501/000-012</a> |
|  | <b>Nr. articol: 793-5501/000-017</b><br>WMB marking card; as card; for terminal block width 5 - 17.5 mm; stretchable 5 - 5.2 mm; plain; snap-on type; green       | <a href="http://www.wago.com/793-5501/000-017">www.wago.com/793-5501/000-017</a> |
|  | <b>Nr. articol: 793-5501/000-023</b><br>WMB marking card; as card; for terminal block width 5 - 17.5 mm; stretchable 5 - 5.2 mm; plain; snap-on type; light green | <a href="http://www.wago.com/793-5501/000-023">www.wago.com/793-5501/000-023</a> |
|  | <b>Nr. articol: 793-5501/000-024</b><br>WMB marking card; as card; for terminal block width 5 - 17.5 mm; stretchable 5 - 5.2 mm; plain; snap-on type; violet      | <a href="http://www.wago.com/793-5501/000-024">www.wago.com/793-5501/000-024</a> |
| <b>End plate</b>   |   |  |
|  | <b>Nr. articol: 280-308</b><br>End and intermediate plate; 2.5 mm thick; gray   | <a href="http://www.wago.com/280-308">www.wago.com/280-308</a>                   |
|  | <b>Nr. articol: 280-309</b><br>End and intermediate plate; 2.5 mm thick; orange   | <a href="http://www.wago.com/280-309">www.wago.com/280-309</a>                   |
|  | <b>Nr. articol: 280-310</b><br>Separator plate; 2 mm thick; oversized; gray   | <a href="http://www.wago.com/280-310">www.wago.com/280-310</a>                   |

Supus modificărilor.

|  |  |  |
|--|--|--|
|  | <b>Nr. articol: 280-311</b><br>Separator plate; 2 mm thick; oversized; orange  | <a href="http://www.wago.com/280-311">www.wago.com/280-311</a> |
|  | <b>Nr. articol: 284-334</b><br>Step-down cover plate; 1 mm thick; for 2-, 3- and 4-conductor terminal blocks; gray   | <a href="http://www.wago.com/284-334">www.wago.com/284-334</a> |
|  | <b>Nr. articol: 284-344</b><br>Step-down cover plate; 1 mm thick; for 2-, 3- and 4-conductor terminal blocks; orange | <a href="http://www.wago.com/284-344">www.wago.com/284-344</a> |

## Descărcări Documentation

### Additional Information

|                        |             |               |            |
|------------------------|-------------|---------------|------------|
| Technical explanations | Apr 3, 2019 | pdf<br>2,1 MB | Descărcare |
|------------------------|-------------|---------------|------------|

## CAD/CAE-Data

### CAD data

|                      |     |            |
|----------------------|-----|------------|
| 2D/3D Models 280-904 | URL | Descărcare |
|----------------------|-----|------------|

### CAE data

|                           |     |            |
|---------------------------|-----|------------|
| EPLAN Data Portal 280-904 | URL | Descărcare |
|---------------------------|-----|------------|

|                        |     |            |
|------------------------|-----|------------|
| WSCAD Universe 280-904 | URL | Descărcare |
|------------------------|-----|------------|

## Installation Notes

### Assembly

Supus modificărilor.

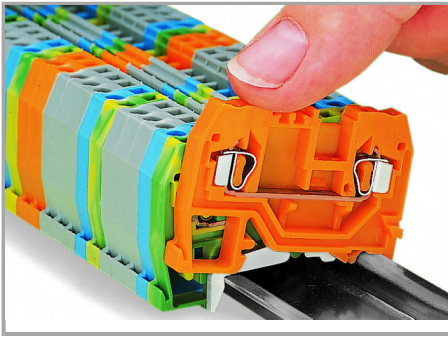

Snapping a terminal block onto the carrier rail.

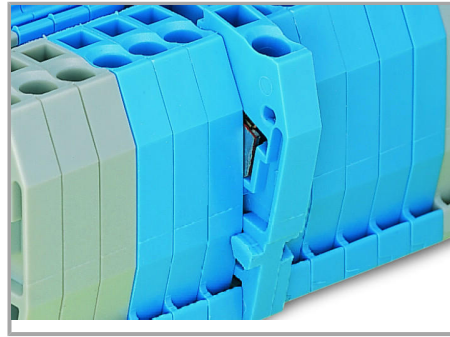

Quick assembly keys prevent reverse mounting.

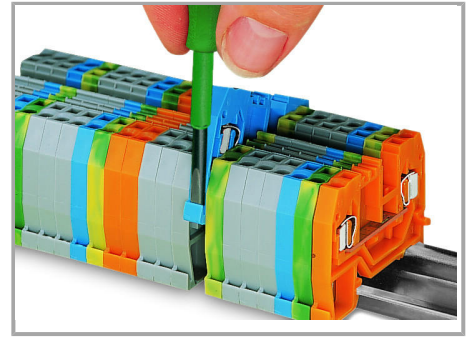

Removing a terminal block from the assembly.

### Inserting a conductor

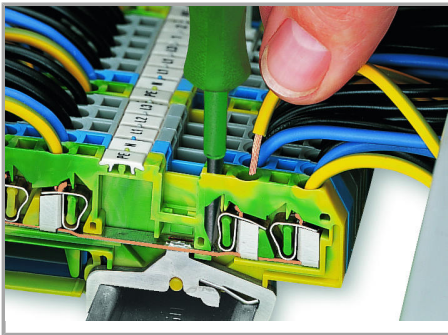

CAGE CLAMP® connection

Inserting a conductor.

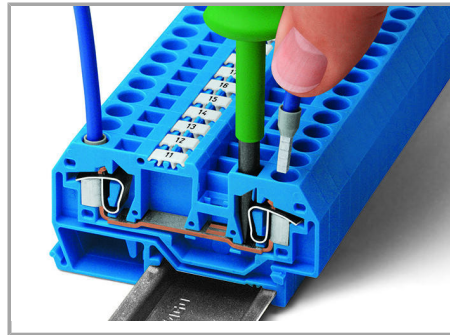

CAGE CLAMP® connection

Inserting a conductor.

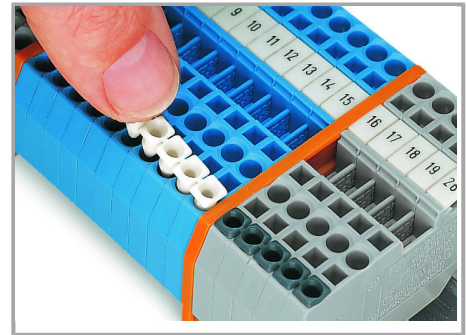

Inserting insulation stops.

With ferruled conductors, it is necessary to use a terminal block one size larger than the conductor's nominal cross-section.

### Commoning

Supus modificărilor.



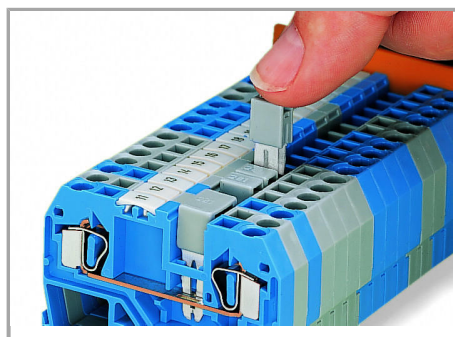

Commoning using an adjacent jumper (280-402).

Push jumper down until fully inserted.

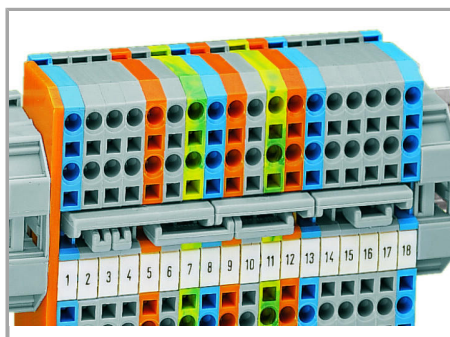

Staggered jumpers for sophisticated circuit requirements – push jumpers down until fully inserted.

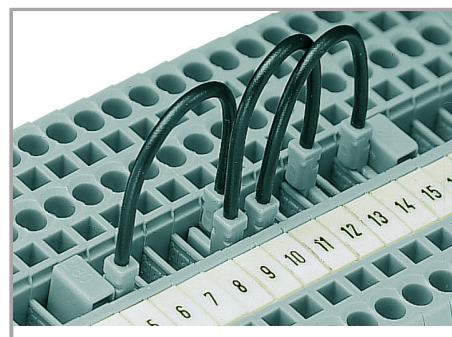

Wire jumpers

When installing machines or control systems, it is often necessary to make an additional connection between two terminal blocks that are not next to each other on the rail. In such cases, WAGO's touch-proof, push-in type wire jumpers are the ideal solution.

These jumpers are compatible with the following rail-mount terminal blocks:

- 279 Series (1.5 mm<sup>2</sup>/16 AWG),
- 
- 280/775/780 Series (2.5 mm<sup>2</sup>/14 AWG)
- 
- 281/769/776/777/781 and 880 Series (4 mm<sup>2</sup>/12 AWG)
- 

They are available in three conductor lengths (60, 110 and 250 mm), allowing up to 60 terminal blocks to be commoned depending on their width (see table on the right).

Supus modificărilor.

Compared with the 279 Series, the 280/775 /780 and 281/776/777/781 Series can also accommodate two wire jumpers, allowing the use of commoning chains. Furthermore, the 280/769/775/780/880 and 281/776/777 /781 Series allow both wire jumper and adjacent jumper to be simultaneously plugged into a same terminal block.

### Testing

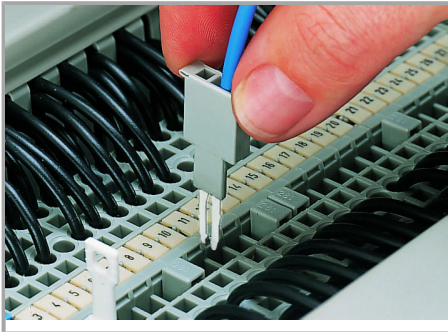

Testing with a test plug

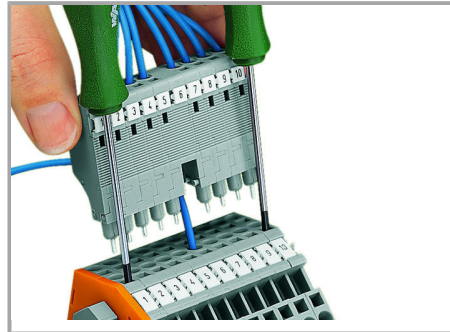

L-type test plug modules fitted with CAGE CLAMP®

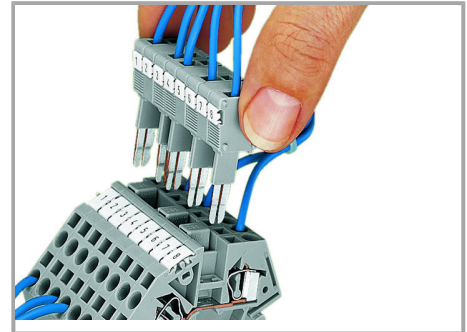

B-type test plug modules fitted with CAGE CLAMP®

(picture shows a test plug fitted with CAGE CLAMP®).

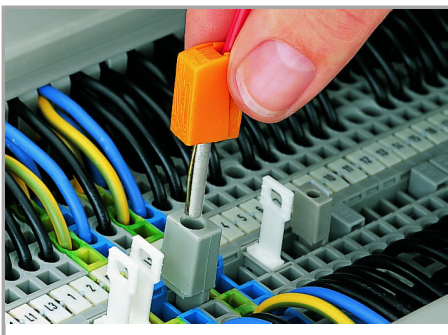

Testing with a test plug

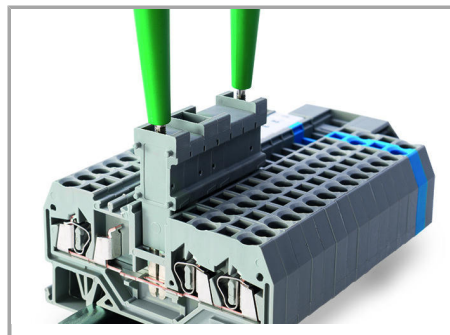

The test plug modules are directly plugged into the jumper contact slot of the current bar.

(picture shows 209-170 Test Plug Adapter).

### Cover

Supus modificărilor.

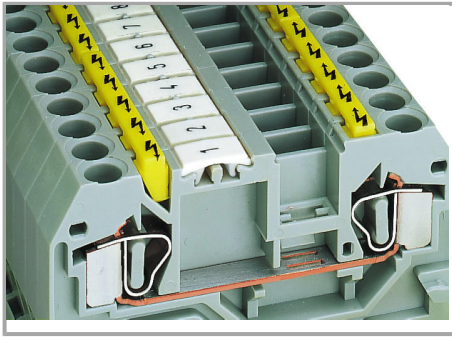

Protective warning markers inserted into the operating slots.

#### Marking

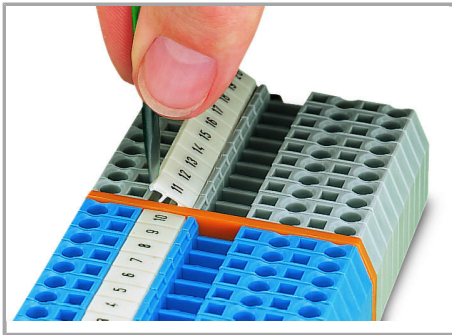

Marking via WMB Multi Marking System.

Supus modificărilor.