

Fișă tehnică | Număr articol: 771-8982/107-803

pre-assembled connecting cable; Eca; Socket/open-ended; 2-pole; Cod. L;
H05VV-F 2 x 2.5 mm²; 8 m; 2,50 mm²; dark gray

www.wago.com/771-8982/107-803

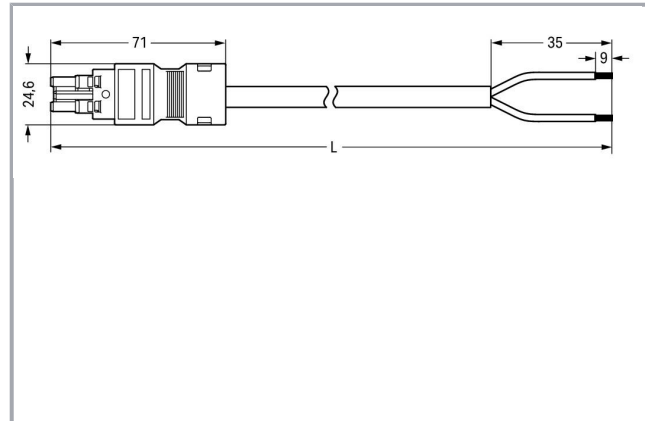
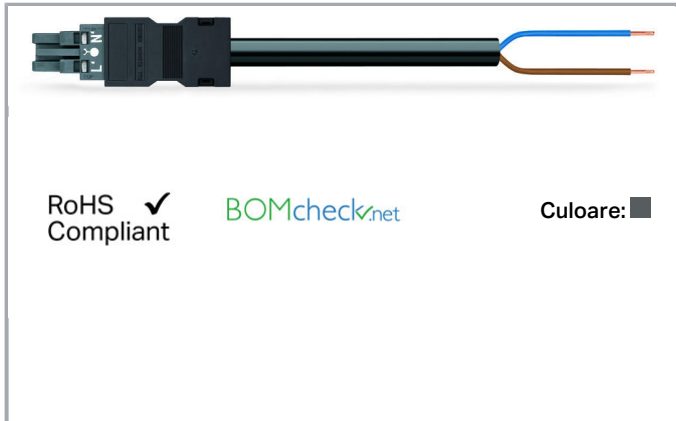

Descriere articol

- Protected against mismatching and maintenance-free
- Push-in CAGE CLAMP® spring pressure connection technology allows solid conductors to be simply pushed into a unit
- Two-wire connection per pole for loops or bridges

Note:

Cables with a different fire class can be found in the eShop.

Note on mismatching protection:

All WINSTA® components are 100% protected against mismatching when:

- plugging different numbers of poles
- plugging while rotated 180
- plugging while laterally staggered
- plugging one pole

Safety information 1:

Application note for the U.S. market (USR): Some versions may also be used for current interruption in accordance with the UL certificate in select applications with currents below 16 A and voltages up to 600 V. For further information, please contact your local sales office.

Date

Electrical data

Note on Contact Resistance

approx. 1 mΩ of contact resistance approx. 0.25 mΩ contact

Supus modificărilor.

WAGO Kontakttechnik GmbH & Co. KG
/Representative Office Romania
Sos. Pipera-Tunari nr. 1/1
building 1, 2nd floor | 077190 Voluntari, Ilfov
Tel.: +40-(0)31 421 85 68 | Email: info-RO@wago.com

Aveți întrebări despre produsele noastre?
Vă stăm la dispoziție pentru preluarea apelului la +40 (0) 31 421 85 68.

transition plug/socket

Ratings per IEC/EN 60664-1

Ratings per	IEC/EN 60664-1
Nominal voltage (III/3)	250 V
Rated surge voltage (III/3)	4 kV
Rated current	20 A
Legend (ratings)	(III / 3) ≙ Overvoltage category III / Pollution degree 3

Approvals per UL 1977

Rated voltage UL 1977	600 V
Rated current UL 1977	23 A

Connection data

Pole No.	2
Total number of potentials	2
Conductor preparation	tip-bonded
Sheathed cable diameter	8,4 ... 10,6 mm
Wire cross-section	2,5 mm ²
Strip length (outer insulation)	35 mm
Connection type	Socket - Free end

Geometrical Data

Pin spacing	10 mm / 0.394 inch
Total length	8 m

Mechanical data

Coding	L
Mating force of a plug-in connection	approx. 20 ... 70 N (depending on pole number)
Retention force of a plug-in connection	when locked: > 80N
Unmating force of a plug-in connection	when unlocked: approx. 20 ... 70 N (depending on pole number)
Number of mating cycles	200 (without resistive load) 100 (with resistive load $I_N = 25$ A), tested (4 mm ²)
Connection type	Socket - Free end
Type of pre-assembled cable	Connecting cable
Cable type	H05VV-F 2x2.5

Supus modificărilor.



Marking	L' N'
Protection type	IP20
Note on protection type	Only when mated (these compact connectors are not designed for use in open, easily accessible areas).
Potential marking	L' N'
Application	Emergency power supply

Plug connection

Mismating protection	Yes
Locking of plug-in connection	locking lever
Locking lever	retrofitable

Material Data

Color	dark gray
Insulation material	Polyamide 66 (PA 66)
Fire class per EN 50575	E _{ca}
Contact material	Copper or copper alloy (surface-treated)
Fire load	239,675 MJ
Connector color	dark gray
Printing color of mating face	white
Strain relief color	black
Printing color of strain relief	white
Sheathed cable color	black
Printing color of sheathed cable	white
Sheath material	PVC
Weight	955,5 g

Environmental Requirements

Processing temperature	-5 ... +40 °C
Continuous operating temperature	-35 ... +85 °C
Note on continuous operating temperature	PVC cable for temperatures ≤ 70 °C (including halogen-free) Insulating parts for temperatures ≤ 105 °C

Commercial data

Packaging type	not packed
Country of origin	DE
GTIN	4055143481014

Supus modificărilor.

WAGO Kontakttechnik GmbH & Co. KG
/Representative Office Romania
Sos. Pipera-Tunari nr. 1/1
building 1, 2nd floor | 077190 Voluntari, Ilfov
Tel.: +40-(0)31 421 85 68 | Email: info-RO@wago.com

Aveți întrebări despre produsele noastre?
Vă stăm la dispoziție pentru preluarea apelului la +40 (0) 31 421 85 68.

Customs tariff number

85444290900

Aprobări / certificate

Country specific Approvals

Emblemă	Aprobare	Text de aprobare suplimentar	Nume certificat
	CCA DEKRA Certification B.V.	EN 61535	NTR NL-7355
	KEMA/KEUR DEKRA Certification B.V.	EN 61535	2179129.01

Counterpart

Produse compatibile

Marking accessories

Nr. articol: 210-334

Marking strips; as a DIN A4 sheet; Strip width 5 mm; Strip length 182 mm; plain; Self-adhesive; white

www.wago.com/210-334

Descărcări

CAD/CAE-Data

CAE data

WSCAD Universe 771-8982/107-803

URL

Descărcare

Installation Notes

Familie de produse

<i>WINSTA</i>® MIDI

Afișare globală produse din familie.

Supus modificărilor.

WAGO Kontakttechnik GmbH & Co. KG
/Representative Office Romania
Sos. Pipera-Tunari nr. 1/1
building 1, 2nd floor | 077190 Voluntari, Ilfov
Tel.: +40-(0)31 421 85 68 | Email: info-RO@wago.com

Aveți întrebări despre produsele noastre?
Vă stăm la dispoziție pentru preluarea apelului la +40 (0) 31 421 85 68.