

Fișă tehnică | Număr articol: 282-124

2-conductor fuse terminal block; for 5 x 20 mm miniature metric fuse; with blown fuse indication by neon lamp; for DIN-rail 35 x 15 and 35 x 7.5; 6 mm²; CAGE CLAMP®; 6,00 mm²; gray

www.wago.com/282-124

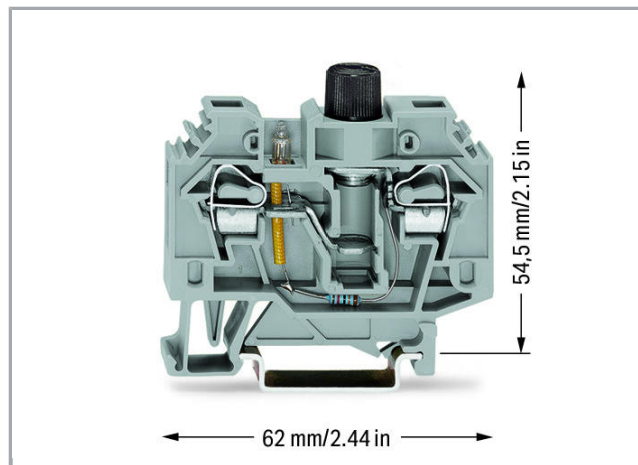
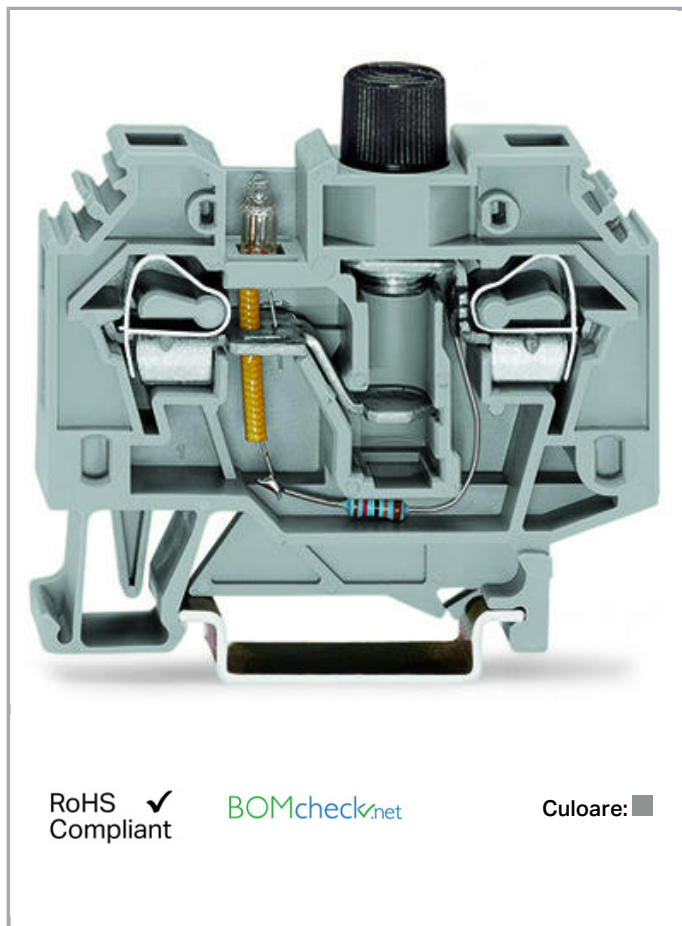

Supus modificărilor.

WAGO Kontakttechnik GmbH & Co. KG
/Representative Office Romania
Sos. Pipera-Tunari nr. 1/1
building 1, 2nd floor | 077190 Voluntari, Ilfov
Tel.: +40-(0)31 421 85 68 | Email: info-RO@wago.com

Aveți întrebări despre produsele noastre?
Vă stăm la dispoziție pentru preluarea apelului la +40 (0) 31 421 85 68.

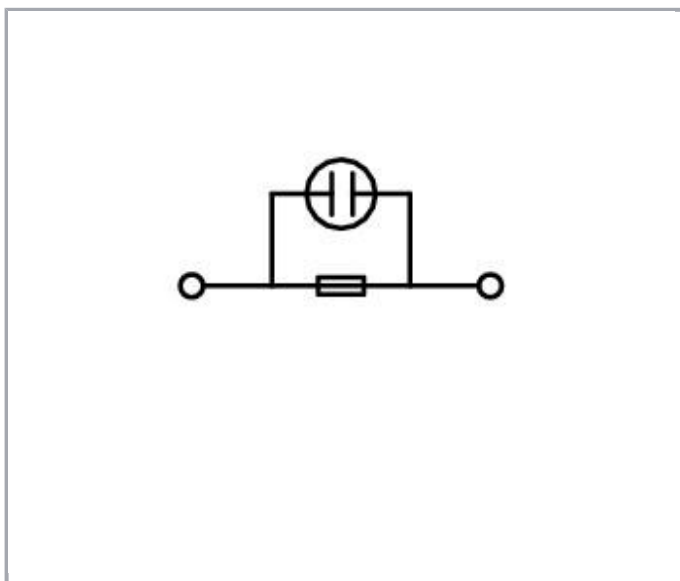
**Date****Electrical data**

Voltage type 1	AC
Voltage type 2	DC

Ratings per IEC/EN 60664-1

Nominal voltage (III/3)	250 V
Rated current	10 A
Rated voltage (III/3) 2	220 V
Legend (ratings)	(III / 3) ≙ Overvoltage category III / Pollution degree 3

Connection data

Connection technology	CAGE CLAMP®
Actuation type	Operating tool
Connectable conductor materials	Copper
Solid conductor	0,2 ... 6 mm ² / 24 ... 10 AWG
Fine-stranded conductor	0,2 ... 6 mm ² / 24 ... 10 AWG
Strip length	12 ... 13 mm / 0.47 ... 0.51 inch
Total number of connection points	2
Total number of potentials	2
Number of levels	1
Wiring type	Side-entry wiring

Supus modificărilor.

WAGO Kontakttechnik GmbH & Co. KG
 /Representative Office Romania
 Sos. Pipera-Tunari nr. 1/1
 building 1, 2nd floor | 077190 Voluntari, Ilfov
 Tel.: +40-(0)31 421 85 68 | Email: info-RO@wago.com

Aveți întrebări despre produsele noastre?
 Vă stăm la dispoziție pentru preluarea apelului la +40 (0) 31 421 85 68.

Geometrical Data

Width	13 mm / 0.512 inch
Height from upper-edge of DIN-rail	54,5 mm / 2.146 inch
Depth	62 mm / 2.441 inch

Mechanical data

Design	horizontal type
Mounting type	DIN-35 rail
Marking level	Side marking

Material Data



Color	gray
Fire load	0,544 MJ
Weight	26,3 g

Commercial data

Product Group	1 (Rail Mounted Terminal Blocks)
Packaging type	BOX
Country of origin	CN
GTIN	4050821110309
Customs tariff number	85369095990

Aprobări / certificate

Country specific Approvals

Emblemă	Aprobare	Text de aprobare suplimentar	Nume certificat
	KEMA/KEUR DEKRA Certification B.V.	EN 60947	NTR NL-7135
	KEMA/KEUR DEKRA Certification B.V.	EN 60947	2160584.31

Ship Approvals

Emblemă	Aprobare	Text de aprobare suplimentar	Nume certificat
Supus modificărilor.			



ABS
American Bureau of Shipping

EN 60947

20-
HG1941090-
PDA



DNV GL
Det Norske Veritas, Germanischer Lloyd

-

TAE00001V2

UL-Approvals

Emblemă	Aprobare	Text de aprobare suplimentar	Nume certificat
	UR Underwriters Laboratories Inc.	UL 1059	E45172

Counterpart

Produse compatibile

Protective Warning Marker



Nr. articol: 282-405
Protective warning marker; with high-voltage symbol, black; for 5 terminal blocks; yellow

www.wago.com/282-405

check



Nr. articol: 209-170
Test plug adapter; 8.3 mm wide; for 4 mm Ø test plugs; suitable for 1.5 mm² - 10 mm² tbs; gray

www.wago.com/209-170

Jumper

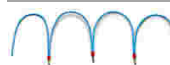

Nr. articol: 210-103
Wire commoning chain; insulated; 50 connections; black

www.wago.com/210-103

















Nr. articol: 210-123
Wire commoning chain; insulated; 50 connections

www.wago.com/210-123

Supus modificărilor.

WAGO Kontakttechnik GmbH & Co. KG
/Representative Office Romania
Sos. Pipera-Tunari nr. 1/1
building 1, 2nd floor | 077190 Voluntari, Ilfov
Tel.: +40-(0)31 421 85 68 | Email: info-RO@wago.com

Aveți întrebări despre produsele noastre?
Vă stăm la dispoziție pentru preluarea apelului la +40 (0) 31 421 85 68.

	Nr. articol: 282-402 Adjacent jumper; insulated; Nominal current 41 A	www.wago.com/282-402
	Nr. articol: 282-409 Alternate jumper; insulated; Nominal current 41 A; gray	www.wago.com/282-409
	Nr. articol: 282-422 Adjacent jumper; insulated; Nominal current 41 A; yellow-green	www.wago.com/282-422
	Nr. articol: 282-424 Adjacent jumper; insulated; Nominal current 41 A; orange	www.wago.com/282-424
	Nr. articol: 709-110 Wire commoning chain; insulated; 4 connections; 3 x 110 mm; black	www.wago.com/709-110
	Nr. articol: 709-111 Wire commoning chain; insulated; 3 connections; 2 x 120 mm; black	www.wago.com/709-111
	Nr. articol: 709-112 Wire commoning chain; insulated; 3 connections; 2 x 170 mm; black	www.wago.com/709-112
End plate		
	Nr. articol: 282-311 End and intermediate plate; 4 mm thick; gray	www.wago.com/282-311
	Nr. articol: 282-312 End and intermediate plate; 4 mm thick; orange	www.wago.com/282-312
Carrier rail		
	Nr. articol: 210-112 Steel carrier rail; 35 x 7.5 mm; 1 mm thick; 2 m long; slotted; according to EN 60715; "Hole width 25 mm	www.wago.com/210-112
	Nr. articol: 210-113 Steel carrier rail; 35 x 7.5 mm; 1 mm thick; 2 m long; unslotted; according to EN 60715	www.wago.com/210-113
	Nr. articol: 210-114 Steel carrier rail; 35 x 15 mm; 1.5 mm thick; 2 m long; unslotted; similar to EN 60715	www.wago.com/210-114
	Nr. articol: 210-115 Steel carrier rail; 35 x 7.5 mm; 1 mm thick; 2 m long; slotted; according to EN 60715; "Hole width 18 mm	www.wago.com/210-115
	Nr. articol: 210-118 Steel carrier rail; 35 x 15 mm; 2.3 mm thick; 2 m long; unslotted; according to EN 60715	www.wago.com/210-118
	Nr. articol: 210-196 Aluminum carrier rail; 35 x 8.2 mm; 1.6 mm thick; 2 m long; unslotted; similar to EN 60715; silver-colored	www.wago.com/210-196
	Nr. articol: 210-197 Steel carrier rail; 35 x 15 mm; 1.5 mm thick; 2 m long; slotted; similar to EN 60715	www.wago.com/210-197
	Nr. articol: 210-198 Copper carrier rail; 35 x 15 mm; 2.3 mm thick; 2 m long; unslotted; according to EN 60715; copper-colored	www.wago.com/210-198

Supus modificărilor.

**Nr. articol: 210-504**

Steel carrier rail; 35 x 7.5 mm; 1 mm thick; 2 m long; slotted; galvanized; according to EN 60715

www.wago.com/210-504**Nr. articol: 210-505**

Steel carrier rail; 35 x 7.5 mm; 1 mm thick; 2 m long; unslotted; galvanized; according to EN 60715

www.wago.com/210-505**Nr. articol: 210-506**

Steel carrier rail; 35 x 15 mm; 1.5 mm thick; 2 m long; unslotted; galvanized; similar to EN 60715

www.wago.com/210-506**Nr. articol: 210-508**

Steel carrier rail; 35 x 15 mm; 1.5 mm thick; 2 m long; slotted; galvanized; similar to EN 60715

www.wago.com/210-508**ferrule****Nr. articol: 216-262**Ferrule; Sleeve for 0.75 mm² / 18 AWG; insulated; electro-tin plated; electrolytic copper; gastight crimped; acc. to DIN 46228, Part 4/09.90; graywww.wago.com/216-262**Nr. articol: 216-263**Ferrule; Sleeve for 1 mm² / AWG 18; insulated; electro-tin plated; electrolytic copper; gastight crimped; acc. to DIN 46228, Part 4/09.90; redwww.wago.com/216-263**Nr. articol: 216-264**Ferrule; Sleeve for 1.5 mm² / AWG 16; insulated; electro-tin plated; electrolytic copper; gastight crimped; acc. to DIN 46228, Part 4/09.90; blackwww.wago.com/216-264**Nr. articol: 216-266**Ferrule; Sleeve for 2.5 mm² / AWG 14; insulated; electro-tin plated; electrolytic copper; gastight crimped; acc. to DIN 46228, Part 4/09.90; bluewww.wago.com/216-266**Nr. articol: 216-267**Ferrule; Sleeve for 4 mm² / AWG 12; insulated; electro-tin plated; electrolytic copper; gastight crimped; acc. to DIN 46228, Part 4/09.90; graywww.wago.com/216-267**assembling****Nr. articol: 209-106**

Mounting carrier; for isolated mounting on DIN 35 rails; gray

www.wago.com/209-106**Nr. articol: 709-153**

Cover; Type 1; suitable for cover carrier, type 1; 1 m long; transparent

www.wago.com/709-153**Marking accessories****Nr. articol: 2009-115**

WMB-Inline; for Smart Printer; 1500 pieces on roll; stretchable 5 - 5.2 mm; plain; snap-on type; white

www.wago.com/2009-115**Nr. articol: 2009-115/000-002**

WMB-Inline; for Smart Printer; 1500 pieces on roll; stretchable 5 - 5.2 mm; plain; snap-on type; yellow

www.wago.com/2009-115/000-002**Nr. articol: 2009-115/000-006**















WMB-Inline; for Smart Printer; 1500 pieces on roll; stretchable 5 - 5.2 mm; plain; snap-on type; blue

www.wago.com/2009-115/000-006**Nr. articol: 2009-115/000-007**

WMB-Inline; for Smart Printer; 1500 pieces on roll; stretchable 5 - 5.2 mm; plain; snap-on type; gray

www.wago.com/2009-115/000-007















Supus modificărilor.

	Nr. articol: 2009-115/000-012 WMB-Inline; for Smart Printer; 1500 pieces on roll; stretchable 5 - 5.2 mm; plain; snap-on type; orange	www.wago.com/2009-115/000-012
	Nr. articol: 2009-115/000-017 WMB-Inline; for Smart Printer; 1500 pieces on roll; stretchable 5 - 5.2 mm; plain; snap-on type; light green	www.wago.com/2009-115/000-017
	Nr. articol: 2009-115/000-023 WMB-Inline; for Smart Printer; 1500 pieces on roll; stretchable 5 - 5.2 mm; plain; snap-on type; green	www.wago.com/2009-115/000-023
	Nr. articol: 2009-115/000-024 WMB-Inline; for Smart Printer; 1500 pieces on roll; stretchable 5 - 5.2 mm; plain; snap-on type; violet	www.wago.com/2009-115/000-024
	Nr. articol: 249-105 Group marker carrier; gray	www.wago.com/249-105
	Nr. articol: 793-501 WMB marking card; as card; not stretchable; plain; snap-on type; white	www.wago.com/793-501
	Nr. articol: 793-501/000-002 WMB marking card; as card; not stretchable; plain; snap-on type; yellow	www.wago.com/793-501/000-002
	Nr. articol: 793-501/000-005 WMB marking card; as card; not stretchable; plain; snap-on type; red	www.wago.com/793-501/000-005
	Nr. articol: 793-501/000-006 WMB marking card; as card; not stretchable; plain; snap-on type; blue	www.wago.com/793-501/000-006
	Nr. articol: 793-501/000-007 WMB marking card; as card; not stretchable; plain; snap-on type; gray	www.wago.com/793-501/000-007
	Nr. articol: 793-501/000-012 WMB marking card; as card; not stretchable; plain; snap-on type; orange	www.wago.com/793-501/000-012
	Nr. articol: 793-501/000-017 WMB marking card; as card; not stretchable; plain; snap-on type; light green	www.wago.com/793-501/000-017
	Nr. articol: 793-501/000-023 WMB marking card; as card; not stretchable; plain; snap-on type; green	www.wago.com/793-501/000-023
	Nr. articol: 793-501/000-024 WMB marking card; as card; not stretchable; plain; snap-on type; violet	www.wago.com/793-501/000-024

Supus modificărilor.

WAGO Kontakttechnik GmbH & Co. KG
/Representative Office Romania
Sos. Pipera-Tunari nr. 1/1
building 1, 2nd floor | 077190 Voluntari, Ilfov
Tel.: +40-(0)31 421 85 68 | Email: info-RO@wago.com

Aveți întrebări despre produsele noastre?
Vă stăm la dispoziție pentru preluarea apelului la +40 (0) 31 421 85 68.

	Nr. articol: 793-5501 WMB marking card; as card; for terminal block width 5 - 17.5 mm; stretchable 5 - 5.2 mm; plain; snap-on type; white	www.wago.com/793-5501
	Nr. articol: 793-5501/000-002 WMB marking card; as card; for terminal block width 5 - 17.5 mm; stretchable 5 - 5.2 mm; plain; snap-on type; yellow	www.wago.com/793-5501/000-002
	Nr. articol: 793-5501/000-005 WMB marking card; as card; for terminal block width 5 - 17.5 mm; stretchable 5 - 5.2 mm; plain; snap-on type; red	www.wago.com/793-5501/000-005
	Nr. articol: 793-5501/000-006 WMB marking card; as card; for terminal block width 5 - 17.5 mm; stretchable 5 - 5.2 mm; plain; snap-on type; blue	www.wago.com/793-5501/000-006
	Nr. articol: 793-5501/000-007 WMB marking card; as card; for terminal block width 5 - 17.5 mm; stretchable 5 - 5.2 mm; plain; snap-on type; gray	www.wago.com/793-5501/000-007
	Nr. articol: 793-5501/000-012 WMB marking card; as card; for terminal block width 5 - 17.5 mm; stretchable 5 - 5.2 mm; plain; snap-on type; orange	www.wago.com/793-5501/000-012
	Nr. articol: 793-5501/000-014 WMB marking card; as card; for terminal block width 5 - 17.5 mm; stretchable 5 - 5.2 mm; plain; snap-on type; brown	www.wago.com/793-5501/000-014
	Nr. articol: 793-5501/000-017 WMB marking card; as card; for terminal block width 5 - 17.5 mm; stretchable 5 - 5.2 mm; plain; snap-on type; green	www.wago.com/793-5501/000-017
	Nr. articol: 793-5501/000-023 WMB marking card; as card; for terminal block width 5 - 17.5 mm; stretchable 5 - 5.2 mm; plain; snap-on type; light green	www.wago.com/793-5501/000-023
	Nr. articol: 793-5501/000-024 WMB marking card; as card; for terminal block width 5 - 17.5 mm; stretchable 5 - 5.2 mm; plain; snap-on type; violet	www.wago.com/793-5501/000-024
General accessories		
	Nr. articol: 209-144 Group marker carrier; gray	www.wago.com/209-144
	Nr. articol: 281-407 Test plug; 6 mm wide; Nominal current 24 A; for 0.08 mm ² - 2.5 mm ² ; 2,50 mm ² ; gray	www.wago.com/281-407
	Nr. articol: 282-451 Miniature metric fuse; without indicator; 5 x 20 mm; medium-slow	www.wago.com/282-451
	Nr. articol: 282-454 Miniature metric fuse; without indicator; L" x 1L"; super quick	www.wago.com/282-454

Supus modificărilor.



Nr. articol: 282-457

Miniature metric fuse; without indicator; L" x 1L"; medium-slow

www.wago.com/282-457

tools



Nr. articol: 210-721

Operating tool; Blade: 5.5 x 0.8 mm; with a partially insulated shaft

www.wago.com/210-721

Descărcări

Documentation

Additional Information

Technical explanations

Apr 3, 2019

pdf
2,1 MB

Descărcare

CAD/CAE-Data

CAE data

EPLAN Data Portal 282-124

URL

Descărcare

WSCAD Universe 282-124

URL

Descărcare

Installation Notes

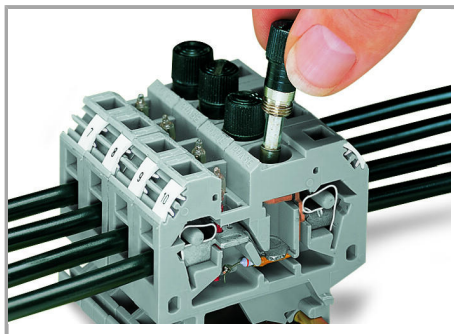

Replacing a fuse.

Supus modificărilor.

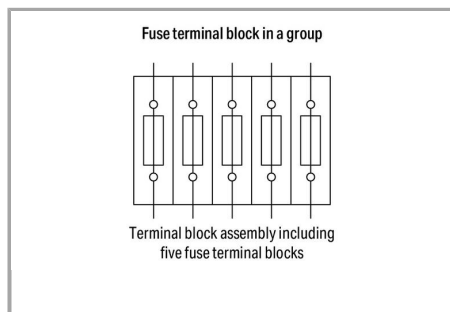
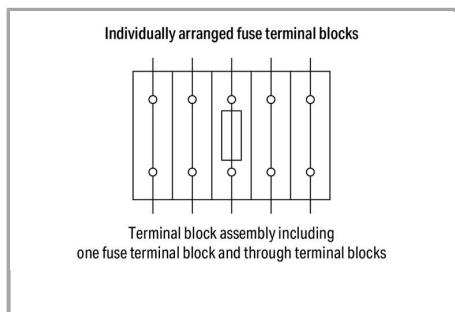

Individually arranged fuse terminal blocks

Fuse terminal blocks in a group

Supus modificărilor.