

## Fișă tehnică | Număr articol: 770-617

T-distribution connector; 5-pole; Cod. I; 1 input; 2 outputs; 2 locking levers;  
blue

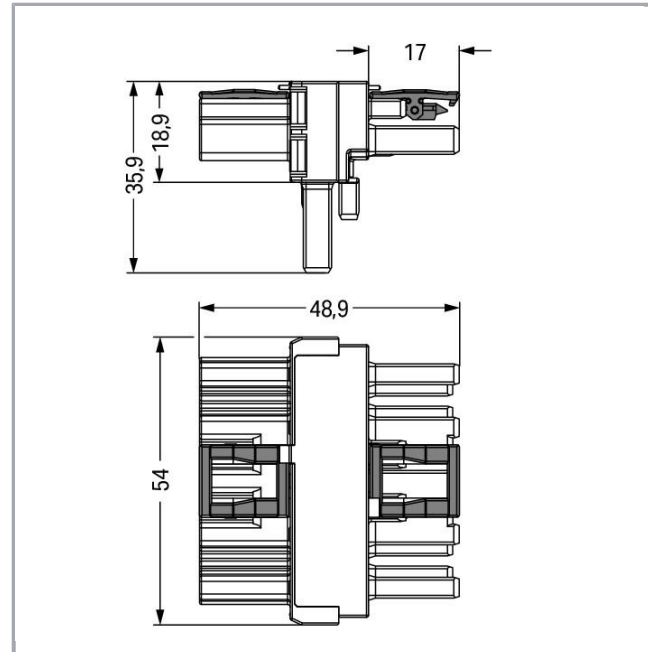

[www.wago.com/770-617](http://www.wago.com/770-617)

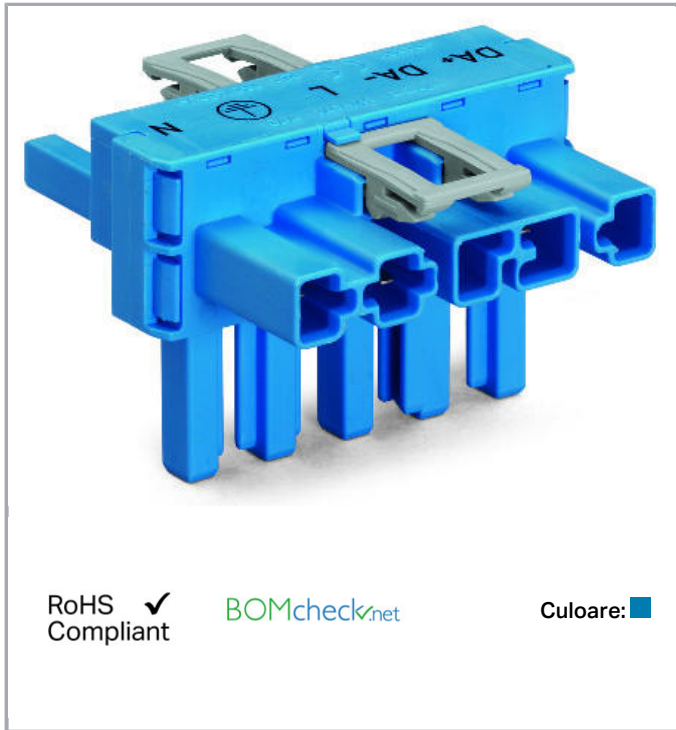

### Descriere articol

- Protected against mismatching and maintenance-free
- Additional variable coding is possible

#### Note:

All connectors for mounted installations (snap-in versions for lighting fixtures or devices, all types of PCB and distribution connectors) are factory-equipped with locking levers to ensure plugs and sockets are securely locked. Additional locking levers are only required for flying leads (plug /socket).

#### Note on mismatching protection:

All WINSTA® components are 100% protected against mismatching when:

- plugging different numbers of poles
- plugging while rotated 180
- plugging while laterally staggered
- plugging one pole

#### Safety information 1:

Application note for the U.S. market (USR): Some versions may also be used for current interruption in accordance with the UL certificate in select applications with currents below 16 A and voltages up to 600 V. For further information, please contact your local sales office.

Supus modificărilor.

WAGO Kontakttechnik GmbH & Co. KG  
/Representative Office Romania  
Sos. Pipera-Tunari nr. 1/1  
building 1, 2nd floor | 077190 Voluntari, Ilfov  
Tel.: +40-(0)31 421 85 68 | Email: info-RO@wago.com

Aveți întrebări despre produsele noastre?

Vă stăm la dispoziție pentru preluarea apelului la +40 (0) 31 421 85 68.

**Date****Electrical data**

|                            |   |
|----------------------------|---|
| Note on Contact Resistance | approx. 1 mΩ of contact resistance approx. 0.25 mΩ contact transition plug/socket |
|----------------------------|---|

**Ratings per IEC/EN 60664-1**

| Ratings per                 | IEC/EN 60664-1  |
|-----------------------------|---|
| Nominal voltage (III/3)     | 400 V   |
| Rated surge voltage (III/3) | 6 kV  |
| Rated current               | 25 A  |
| Legend (ratings)            | (III / 3) ≙ Overvoltage category III / Pollution degree 3 |

**Approvals per UL 1977**

|                       |       |
|-----------------------|-------|
| Rated voltage UL 1977 | 600 V |
| Rated current UL 1977 | 23 A  |

**Connection data**

|                            |                               |
|----------------------------|-------------------------------|
| Pole No.                   | 5                             |
| Total number of potentials | 5                             |
| Ground function            | with preceding ground contact |

**Geometrical Data**

|             |                      |
|-------------|----------------------|
| Pin spacing | 10 mm / 0.394 inch   |
| Width       | 54 mm / 2.126 inch   |
| Height      | 35,9 mm / 1.413 inch |
| Depth       | 48,9 mm / 1.925 inch |

**Mechanical data**

|   |   |
|---|---|
| Technologie                             | DALI  |
| Coding                                  | I   |
| Mating force of a plug-in connection    | approx. 20 ... 70 N (depending on pole number)  |
| Retention force of a plug-in connection | When locked: > 80 N   |
| Unmating force of a plug-in connection  | when unlocked: approx. 20 ... 70 N (depending on pole number)   |
| Number of mating cycles                 | 200, without resistive load 100, with resistive load $I_N = 25$ A, tested (4 mm <sup>2</sup> /AWG 12) |

Supus modificărilor.

WAGO Kontakttechnik GmbH & Co. KG  
 /Representative Office Romania  
 Sos. Pipera-Tunari nr. 1/1  
 building 1, 2nd floor | 077190 Voluntari, Ilfov  
 Tel.: +40-(0)31 421 85 68 | Email: info-RO@wago.com

Aveți întrebări despre produsele noastre?  
 Vă stăm la dispoziție pentru preluarea apelului la +40 (0) 31 421 85 68.



|                         |   |
|-------------------------|---|
| Distributor type        | T-distribution connector  |
| Marking                 | N L DA- DA+   |
| Protection type         | IP20  |
| Note on protection type | Only when mated (these compact connectors are not designed for use in open, easily accessible areas). |
| Potential marking       | N L DA- DA+   |
| Application             | Lighting management   |

### Plug connection

|                                    |               |
|------------------------------------|---------------|
| Contact type (pluggable connector) | Socket/plug   |
| Mismating protection               | Yes           |
| Locking of plug-in connection      | locking lever |
| Locking lever                      | yes           |

### Material Data

|                     |  |
|---------------------|--|
| Color               | blue                                     |
| Insulation material | Polyamide 66 (PA 66)                     |
| Contact material    | Copper or copper alloy (surface-treated) |
| Fire load           | 0,453 MJ                                 |
| Weight              | 24,3 g                                   |

### Environmental Requirements

|  |   |
|--|---|
| Processing temperature                   | -5 ... +40 °C                                   |
| Continuous operating temperature         | -35 ... +85 °C                                  |
| Note on continuous operating temperature | Insulating parts for temperatures $\leq 105$ °C |

### Commercial data

|                       |               |
|-----------------------|---------------|
| Packaging type        | BOX           |
| Country of origin     | DE            |
| GTIN                  | 4044918934961 |
| Customs tariff number | 85366990990   |

### Aprobări / certificate

#### Country specific Approvals

| Emblemă | Aprobare | Text de aprobare suplimentar | Nume certificat |
|---------|----------|------------------------------|-----------------|
|         | CCA      | EN 61535                     | 2173495.02      |

Supus modificărilor.



WAGO Kontakttechnik GmbH & Co. KG  
 /Representative Office Romania  
 Sos. Pipera-Tunari nr. 1/1  
 building 1, 2nd floor | 077190 Voluntari, Ilfov  
 Tel.: +40-(0)31 421 85 68 | Email: info-RO@wago.com

Aveți întrebări despre produsele noastre?  
 Vă stăm la dispoziție pentru preluarea apelului la +40 (0) 31 421 85 68.

DEKRA Certification B.V.









## Ship Approvals

| Embleă  | Aprobare  | Text de aprobare suplimentar | Nume certificat          |
|---|---|------------------------------|--------------------------|
|   | <b>ABS</b><br>American Bureau of Shipping               | -                            | 19-<br>HG1868589-<br>PDA |
|   | <b>DNV GL</b><br>Det Norske Veritas, Germanischer Lloyd | -                            | TAE00001Z6               |
|  | <b>LR</b><br>Lloyds Register                            | IEC 61984                    | 02/20050<br>(E6)         |

## UL-Approvals

| Embleă   | Aprobare                                       | Text de aprobare suplimentar | Nume certificat  |
|--|--|------------------------------|------------------|
|  | <b>cURus</b><br>Underwriters Laboratories Inc. | UL 1977                      | E45171<br>Sec. 9 |

## Counterpart

|  |  |  |
|--|--|--|
|  | <b>Nr. articol770-1105</b><br>Socket; 5-pole; Cod. I; 4,00 mm <sup>2</sup> ; blue  | <a href="http://www.wago.com/770-1105">www.wago.com/770-1105</a>                 |
|  | <b>Nr. articol770-1105/022-000</b><br>Socket; with strain relief housing; 5-pole; Cod. I; 4,00 mm <sup>2</sup> ; blue  | <a href="http://www.wago.com/770-1105/022-000">www.wago.com/770-1105/022-000</a> |
|  | <b>Nr. articol770-1115</b><br>Plug; 5-pole; Cod. I; 4,00 mm <sup>2</sup> ; blue  | <a href="http://www.wago.com/770-1115">www.wago.com/770-1115</a>                 |
|  | <b>Nr. articol770-1115/022-000</b><br>Plug; with strain relief housing; 5-pole; Cod. I; 4,00 mm <sup>2</sup> ; blue  | <a href="http://www.wago.com/770-1115/022-000">www.wago.com/770-1115/022-000</a> |
|  | <b>Nr. articol771-9985/006-101</b><br>pre-assembled interconnecting cable; Eca; Socket/plug; 5-pole; Cod. I; H05VV-F 5G 1.5 mm <sup>2</sup> ; 1 m; 1,50 mm <sup>2</sup> ; blue | <a href="http://www.wago.com/771-9985/006-101">www.wago.com/771-9985/006-101</a> |
|  | <b>Nr. articol771-9985/106-101</b>   | <a href="http://www.wago.com/771-9985">www.wago.com/771-9985</a>                 |

Supus modificărilor.

WAGO Kontakttechnik GmbH & Co. KG  
/Representative Office Romania  
Sos. Pipera-Tunari nr. 1/1  
building 1, 2nd floor | 077190 Voluntari, Ilfov  
Tel.: +40-(0)31 421 85 68 | Email: info-RO@wago.com

Aveți întrebări despre produsele noastre?  
Vă stăm la dispoziție pentru preluarea apelului la +40 (0) 31 421 85 68.

pre-assembled connecting cable; Eca; Socket/open-ended; 5-pole; Cod. I; H05VV-F 5G 1.5 mm<sup>2</sup>; 1 m; 1,50 mm<sup>2</sup>; blue /106-101



Nr. articol 771-9985/206-101

pre-assembled connecting cable; Eca; Plug/open-ended; 5-pole; Cod. I; H05VV-F 5G 1.5 mm<sup>2</sup>; 1 m; 1,50 mm<sup>2</sup>; blue

[www.wago.com/771-9985/206-101](http://www.wago.com/771-9985/206-101)

## Descărcări

### CAD/CAE-Data

#### CAD data

2D/3D Models 770-617

[URL](#)

[Descărcare](#)

#### CAE data

EPLAN Data Portal 770-617

[URL](#)

[Descărcare](#)

WSCAD Universe 770-617

[URL](#)

[Descărcare](#)

## Installation Notes

### Installation

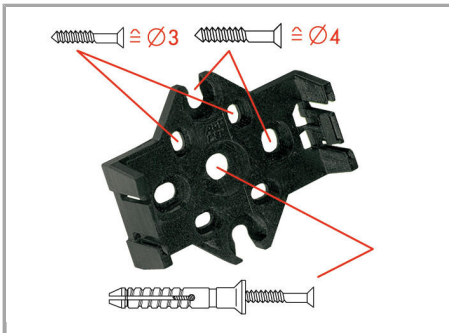

The mounting plate for distribution connectors can be mounted using commercially available screws or nail-drive anchors.



The distribution connectors are latched when mounted on the mounting plate.



To release the distribution connector, unlock the latch using a screwdriver.

Supus modificărilor.

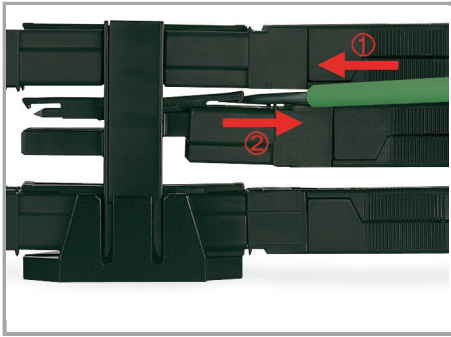

All distributor connections are locked and protected against accidental disconnection directly after mating. Locking of any connection is released using a screwdriver, even if all connections are in use.

## Familie de produse

*WINSTA*® MIDI

Afișare globală produse din familie.

Supus modificărilor.