

Fișă tehnică | Număr articol: 283-677

3-conductor ground terminal block; 16 mm²; center marking; for DIN-rail 35 x 15 and 35 x 7.5; CAGE CLAMP®; 16,00 mm²; green-yellow

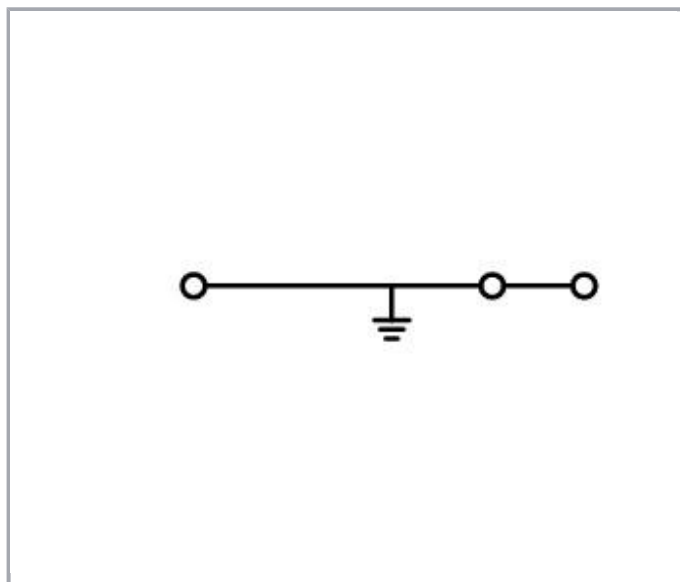

www.wago.com/283-677

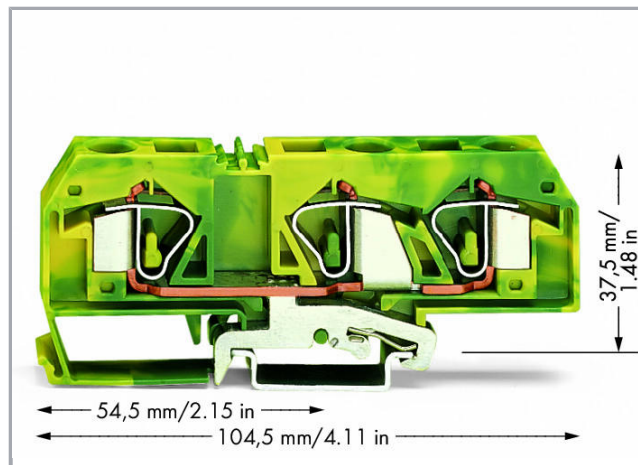
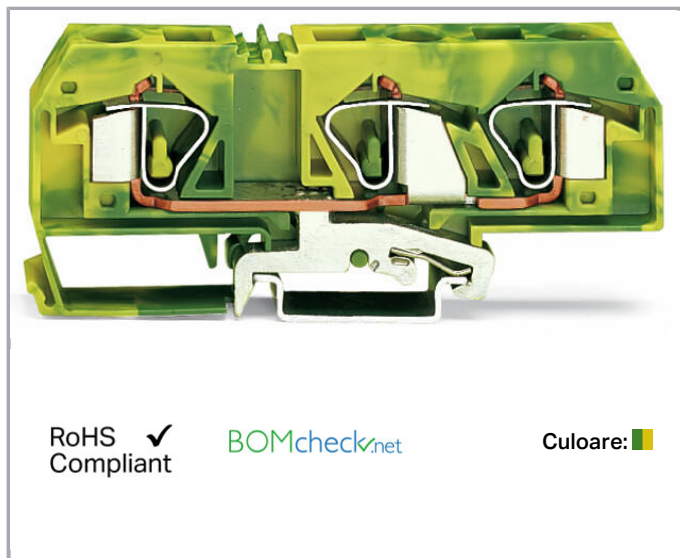

Descriere articol

Safety information 1:

Notice: This (ground) earth conductor terminal block cannot be commoned with adjacent jumpers.

Supus modificărilor.

WAGO Kontakttechnik GmbH & Co. KG
/Representative Office Romania
Sos. Pipera-Tunari nr. 1/1
building 1, 2nd floor | 077190 Voluntari, Ilfov
Tel.: +40-(0)31 421 85 68 | Email: info-RO@wago.com

Aveți întrebări despre produsele noastre?
Vă stăm la dispoziție pentru preluarea apelului la +40 (0) 31 421 85 68.

**Date****Electrical data****Ratings per IEC/EN 60664-1**

Ratings per	IEC/EN 60947-7-2
-------------	------------------

Connection data

Connection technology	CAGE CLAMP®
Actuation type	Operating tool
Connectable conductor materials	Copper
Solid conductor	0,2 ... 16 mm ² / 24 ... 6 AWG
Fine-stranded conductor	0,2 ... 16 mm ² / 24 ... 6 AWG
Strip length	16 ... 17 mm / 0.63 ... 0.67 inch
Total number of connection points	3
Total number of potentials	1
Number of levels	1
Wiring type	Front-entry wiring

Geometrical Data

Width	12 mm / 0.472 inch
Height from upper-edge of DIN-rail	37,5 mm / 1.476 inch
Depth	104,5 mm / 4.114 inch

Mechanical data

Design	horizontal
Mounting type	DIN-35 rail
Marking level	Center marking

Material Data

Color	green-yellow
Insulation material	Polyamide 66 (PA 66)
Weight	57,3g

Commercial data

Packaging type	BOX
----------------	-----

Supus modificărilor.



WAGO Kontakttechnik GmbH & Co. KG
 /Representative Office Romania
 Sos. Pipera-Tunari nr. 1/1
 building 1, 2nd floor | 077190 Voluntari, Ilfov
 Tel.: +40-(0)31 421 85 68 | Email: info-RO@wago.com

Aveți întrebări despre produsele noastre?
 Vă stăm la dispoziție pentru preluarea apelului la +40 (0) 31 421 85 68.





Country of origin	DE
GTIN	4045454084554
Customs tariff number	85369010000

Aprobări / certificate

Country specific Approvals

Emblemă	Aprobare	Text de aprobare suplimentar	Nume certificat
	CCA DEKRA Certification B.V.	EN 60947	NTR NL-7456/A1
	CSA DEKRA Certification B.V.	C22.2 No. 158	1536072
	KEMA/KEUR DEKRA Certification B.V.	EN 60947	2187239.03

Ship Approvals

Emblemă	Aprobare	Text de aprobare suplimentar	Nume certificat
	ABS American Bureau of Shipping	-	20-HG1941090-PDA
	BV Bureau Veritas S.A.	EN 60947	07436/E0 BV
	DNV GL Det Norske Veritas, Germanischer Lloyd	-	TAE00001V2
	LR Lloyds Register	EN 60947	91/20112 (E9)

UL-Approvals

Nume

Supus modificărilor.

WAGO Kontakttechnik GmbH & Co. KG
/Representative Office Romania
Sos. Pipera-Tunari nr. 1/1
building 1, 2nd floor | 077190 Voluntari, Ilfov
Tel.: +40-(0)31 421 85 68 | Email: info-RO@wago.com



Aveți întrebări despre produsele noastre?
Vă stăm la dispoziție pentru preluarea apelului la +40 (0) 31 421 85 68.

Emblemă	Aprobare	Text de aprobare suplimentar	certificat
	UL UL International Germany GmbH	UL 1059	20190731- E45172

Counterpart

Produse compatibile

End plate

	Nr. articol: 283-350 End and intermediate plate; 2.5 mm thick; gray	www.wago.com/283-350
	Nr. articol: 283-351 Separator plate; 2 mm thick; oversized; gray	www.wago.com/283-351
	Nr. articol: 283-352 End and intermediate plate; 2.5 mm thick; orange	www.wago.com/283-352
	Nr. articol: 283-353 Separator plate; 2 mm thick; oversized; orange	www.wago.com/283-353

Protective Warning Marker

	Nr. articol: 283-415 Protective warning marker; with high-voltage symbol, black; for 5 terminal blocks; yellow	www.wago.com/283-415
--	--	--

tools

	Nr. articol: 210-721 Operating tool; Blade: 5.5 x 0.8 mm; with a partially insulated shaft	www.wago.com/210-721
--	--	--

protection

	Nr. articol: 283-400 Finger guard; touchproof cover protects unused conductor entries; yellow	www.wago.com/283-400
--	---	--

assembling

	Nr. articol: 209-106 Mounting carrier; for isolated mounting on DIN 35 rails; gray	www.wago.com/209-106
--	--	--

Supus modificărilor.



Nr. articol: 709-154

Cover; Type 2; suitable for cover carrier, type 2; 1 m long; transparent

www.wago.com/709-154

ferrule



Nr. articol: 216-108

Ferrule; Sleeve for 6 mm² / AWG 10; uninsulated; electro-tin platedwww.wago.com/216-108

Nr. articol: 216-109

Ferrule; Sleeve for 10 mm² / AWG 8; uninsulated; electro-tin platedwww.wago.com/216-109

Nr. articol: 216-284

Ferrule; Sleeve for 1.5 mm² / AWG 16; insulated; electro-tin plated; electrolytic copper; gastight crimped; acc. to DIN 46228, Part 4/09.90; blackwww.wago.com/216-284

Nr. articol: 216-286

Ferrule; Sleeve for 2.5 mm² / AWG 14; insulated; electro-tin plated; electrolytic copper; gastight crimped; acc. to DIN 46228, Part 4/09.90; bluewww.wago.com/216-286

Nr. articol: 216-287

Ferrule; Sleeve for 4 mm² / AWG 12; insulated; electro-tin plated; electrolytic copper; gastight crimped; acc. to DIN 46228, Part 4/09.90; graywww.wago.com/216-287

Nr. articol: 216-288

Ferrule; Sleeve for 6 mm² / AWG 10; insulated; electro-tin plated; electrolytic copper; gastight crimped; acc. to DIN 46228, Part 4/09.90; yellowwww.wago.com/216-288

Nr. articol: 216-289

Ferrule; Sleeve for 10 mm² / AWG 8; insulated; electro-tin plated; electrolytic copper; gastight crimped; acc. to DIN 46228, Part 4/09.90; redwww.wago.com/216-289

Marking accessories



Nr. articol: 2009-115

WMB-Inline; for Smart Printer; 1500 pieces on roll; stretchable 5 - 5.2 mm; plain; snap-on type; white

www.wago.com/2009-115

Nr. articol: 2009-115/000-002

WMB-Inline; for Smart Printer; 1500 pieces on roll; stretchable 5 - 5.2 mm; plain; snap-on type; yellow

www.wago.com/2009-115/000-002

Nr. articol: 2009-115/000-006

WMB-Inline; for Smart Printer; 1500 pieces on roll; stretchable 5 - 5.2 mm; plain; snap-on type; blue

www.wago.com/2009-115/000-006

Nr. articol: 2009-115/000-007

WMB-Inline; for Smart Printer; 1500 pieces on roll; stretchable 5 - 5.2 mm; plain; snap-on type; gray

www.wago.com/2009-115/000-007

Nr. articol: 2009-115/000-012

WMB-Inline; for Smart Printer; 1500 pieces on roll; stretchable 5 - 5.2 mm; plain; snap-on type; orange

www.wago.com/2009-115/000-012

Nr. articol: 2009-115/000-017

WMB-Inline; for Smart Printer; 1500 pieces on roll; stretchable 5 - 5.2 mm; plain; snap-on type; light green















www.wago.com/2009-115/000-017

Supus modificărilor.

WAGO Kontakttechnik GmbH & Co. KG
 /Representative Office Romania
 Sos. Pipera-Tunari nr. 1/1
 building 1, 2nd floor | 077190 Voluntari, Ilfov
 Tel.: +40-(0)31 421 85 68 | Email: info-RO@wago.com

Aveți întrebări despre produsele noastre?

Vă stăm la dispoziție pentru preluarea apelului la +40 (0) 31 421 85 68.

	<p>Nr. articol: 2009-115/000-023 WMB-Inline; for Smart Printer; 1500 pieces on roll; stretchable 5 - 5.2 mm; plain; snap-on type; green</p>	www.wago.com/2009-115/000-023
	<p>Nr. articol: 2009-115/000-024 WMB-Inline; for Smart Printer; 1500 pieces on roll; stretchable 5 - 5.2 mm; plain; snap-on type; violet</p>	www.wago.com/2009-115/000-024
	<p>Nr. articol: 209-185 Adaptor; gray</p>	www.wago.com/209-185
	<p>Nr. articol: 249-105 Group marker carrier; gray</p>	www.wago.com/249-105
	<p>Nr. articol: 793-501 WMB marking card; as card; not stretchable; plain; snap-on type; white</p>	www.wago.com/793-501
	<p>Nr. articol: 793-501/000-002 WMB marking card; as card; not stretchable; plain; snap-on type; yellow</p>	www.wago.com/793-501/000-002
	<p>Nr. articol: 793-501/000-005 WMB marking card; as card; not stretchable; plain; snap-on type; red</p>	www.wago.com/793-501/000-005
	<p>Nr. articol: 793-501/000-006 WMB marking card; as card; not stretchable; plain; snap-on type; blue</p>	www.wago.com/793-501/000-006
	<p>Nr. articol: 793-501/000-007 WMB marking card; as card; not stretchable; plain; snap-on type; gray</p>	www.wago.com/793-501/000-007
	<p>Nr. articol: 793-501/000-012 WMB marking card; as card; not stretchable; plain; snap-on type; orange</p>	www.wago.com/793-501/000-012
	<p>Nr. articol: 793-501/000-017 WMB marking card; as card; not stretchable; plain; snap-on type; light green</p>	www.wago.com/793-501/000-017
	<p>Nr. articol: 793-501/000-023 WMB marking card; as card; not stretchable; plain; snap-on type; green</p>	www.wago.com/793-501/000-023
	<p>Nr. articol: 793-501/000-024 WMB marking card; as card; not stretchable; plain; snap-on type; violet</p>	www.wago.com/793-501/000-024
	<p>Nr. articol: 793-5501 WMB marking card; as card; for terminal block width 5 - 17.5 mm; stretchable 5 - 5.2 mm; plain; snap-on type; white</p>	www.wago.com/793-5501
	<p>Nr. articol: 793-5501/000-002</p>	

Supus modificărilor.



WMB marking card; as card; for terminal block width 5 - 17.5 mm; stretchable 5 - 5.2 mm; plain; snap-on type; yellow www.wago.com/793-5501/000-002



Nr. articol: 793-5501/000-005
WMB marking card; as card; for terminal block width 5 - 17.5 mm; stretchable 5 - 5.2 mm; plain; snap-on type; red www.wago.com/793-5501/000-005



Nr. articol: 793-5501/000-006
WMB marking card; as card; for terminal block width 5 - 17.5 mm; stretchable 5 - 5.2 mm; plain; snap-on type; blue www.wago.com/793-5501/000-006



Nr. articol: 793-5501/000-007
WMB marking card; as card; for terminal block width 5 - 17.5 mm; stretchable 5 - 5.2 mm; plain; snap-on type; gray www.wago.com/793-5501/000-007



Nr. articol: 793-5501/000-012
WMB marking card; as card; for terminal block width 5 - 17.5 mm; stretchable 5 - 5.2 mm; plain; snap-on type; orange www.wago.com/793-5501/000-012



Nr. articol: 793-5501/000-017
WMB marking card; as card; for terminal block width 5 - 17.5 mm; stretchable 5 - 5.2 mm; plain; snap-on type; green www.wago.com/793-5501/000-017



Nr. articol: 793-5501/000-023
WMB marking card; as card; for terminal block width 5 - 17.5 mm; stretchable 5 - 5.2 mm; plain; snap-on type; light green www.wago.com/793-5501/000-023



Nr. articol: 793-5501/000-024
WMB marking card; as card; for terminal block width 5 - 17.5 mm; stretchable 5 - 5.2 mm; plain; snap-on type; violet www.wago.com/793-5501/000-024

Carrier rail



Nr. articol: 210-112
Steel carrier rail; 35 x 7.5 mm; 1 mm thick; 2 m long; slotted; according to EN 60715; "Hole width 25 mm" www.wago.com/210-112

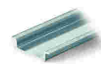

Nr. articol: 210-113
Steel carrier rail; 35 x 7.5 mm; 1 mm thick; 2 m long; unslotted; according to EN 60715 www.wago.com/210-113



Nr. articol: 210-114
Steel carrier rail; 35 x 15 mm; 1.5 mm thick; 2 m long; unslotted; similar to EN 60715 www.wago.com/210-114



Nr. articol: 210-115
Steel carrier rail; 35 x 7.5 mm; 1 mm thick; 2 m long; slotted; according to EN 60715; "Hole width 18 mm" www.wago.com/210-115



Nr. articol: 210-118
Steel carrier rail; 35 x 15 mm; 2.3 mm thick; 2 m long; unslotted; according to EN 60715 www.wago.com/210-118

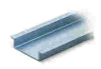

Nr. articol: 210-196
Aluminum carrier rail; 35 x 8.2 mm; 1.6 mm thick; 2 m long; unslotted; similar to EN 60715; silver-colored www.wago.com/210-196

Nr. articol: 210-197
Steel carrier rail; 35 x 15 mm; 1.5 mm thick; 2 m long; slotted; similar to EN 60715 www.wago.com/210-197

Supus modificărilor.

**Nr. articol: 210-198**

Copper carrier rail; 35 x 15 mm; 2.3 mm thick; 2 m long; unslotted; according to EN 60715; copper-colored

www.wago.com/210-198**Nr. articol: 210-504**

Steel carrier rail; 35 x 7.5 mm; 1 mm thick; 2 m long; slotted; galvanized; according to EN 60715

www.wago.com/210-504**Nr. articol: 210-505**

Steel carrier rail; 35 x 7.5 mm; 1 mm thick; 2 m long; unslotted; galvanized; according to EN 60715

www.wago.com/210-505**Nr. articol: 210-506**

Steel carrier rail; 35 x 15 mm; 1.5 mm thick; 2 m long; unslotted; galvanized; similar to EN 60715

www.wago.com/210-506**Nr. articol: 210-508**

Steel carrier rail; 35 x 15 mm; 1.5 mm thick; 2 m long; slotted; galvanized; similar to EN 60715

www.wago.com/210-508**Descărcări****Documentation****Additional Information**

Technical explanations

Apr 3, 2019

pdf
2,1 MB

Descărcare

CAD/CAE-Data**CAD data**

2D/3D Models 283-677

URL

Descărcare

CAE data

EPLAN Data Portal 283-677

URL

Descărcare

WSCAD Universe 283-677

URL

Descărcare

Installation Notes**Installation**

Supus modificărilor.

WAGO Kontakttechnik GmbH & Co. KG
/Representative Office Romania
Sos. Pipera-Tunari nr. 1/1
building 1, 2nd floor | 077190 Voluntari, Ilfov
Tel.: +40-(0)31 421 85 68 | Email: info-RO@wago.com

Aveți întrebări despre produsele noastre?

Vă stăm la dispoziție pentru preluarea apelului la +40 (0) 31 421 85 68.

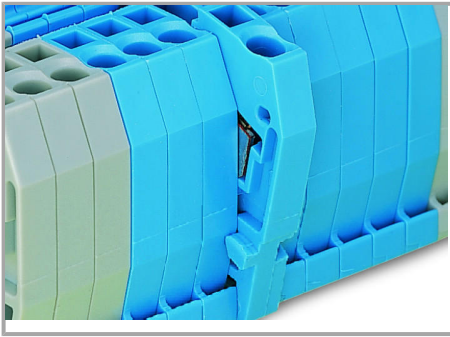

Quick assembly keys prevent reverse mounting.

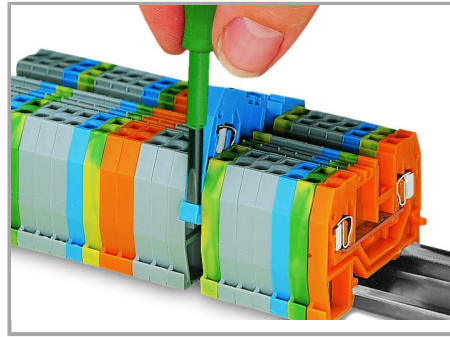

Removing a terminal block from the assembly.

Inserting a conductor

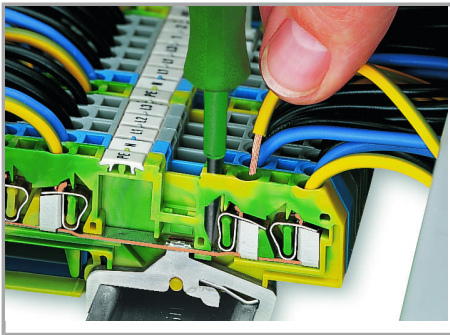

CAGE CLAMP® connection

Inserting a conductor.

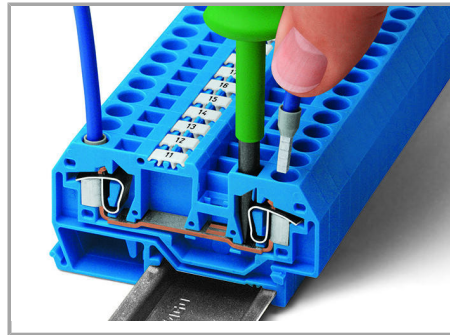

CAGE CLAMP® connection

Inserting a conductor.

With ferruled conductors, it is necessary to use a terminal block one size larger than the conductor's nominal cross-section.

Voltage Tap

Supus modificărilor.

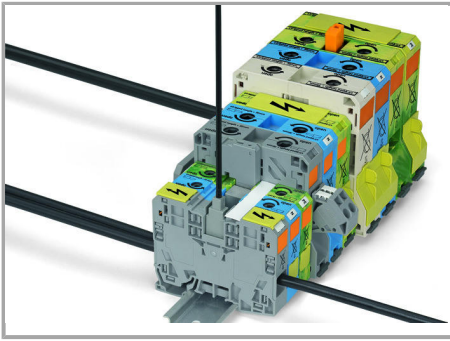

Always push power tap (283-407) down into the terminal block until fully inserted!

Marking

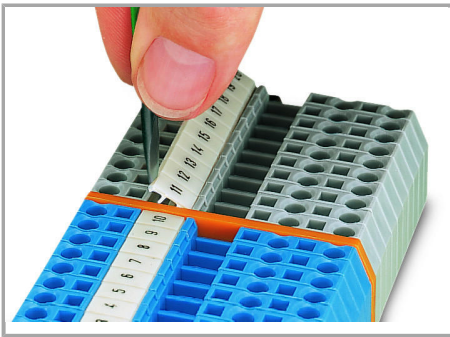

Marking via WMB Multi Marking System.

Supus modificărilor.