

Fișă tehnică | Număr articol: 231-603/019-000

1-conductor male connector; clamping collar; 2.5 mm²; Pin spacing 5 mm; 3-pole; 2,50 mm²; gray

www.wago.com/231-603/019-000

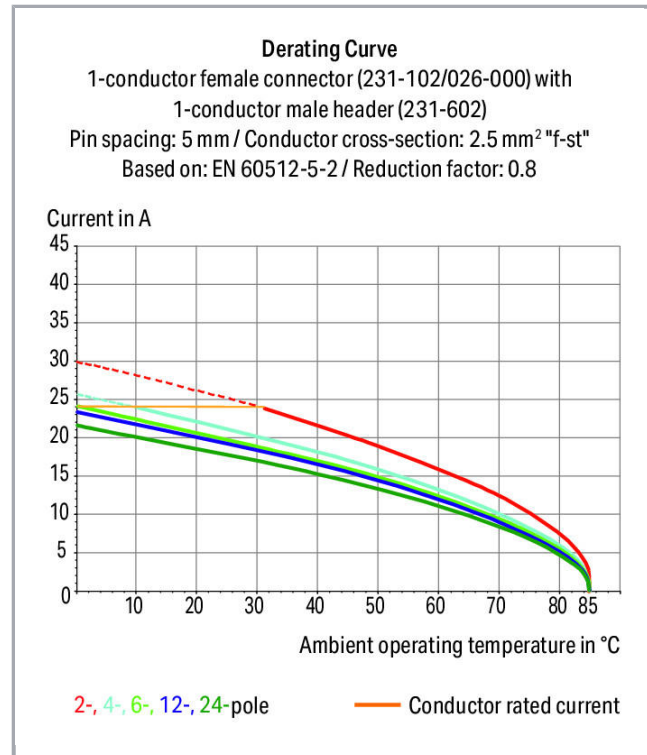
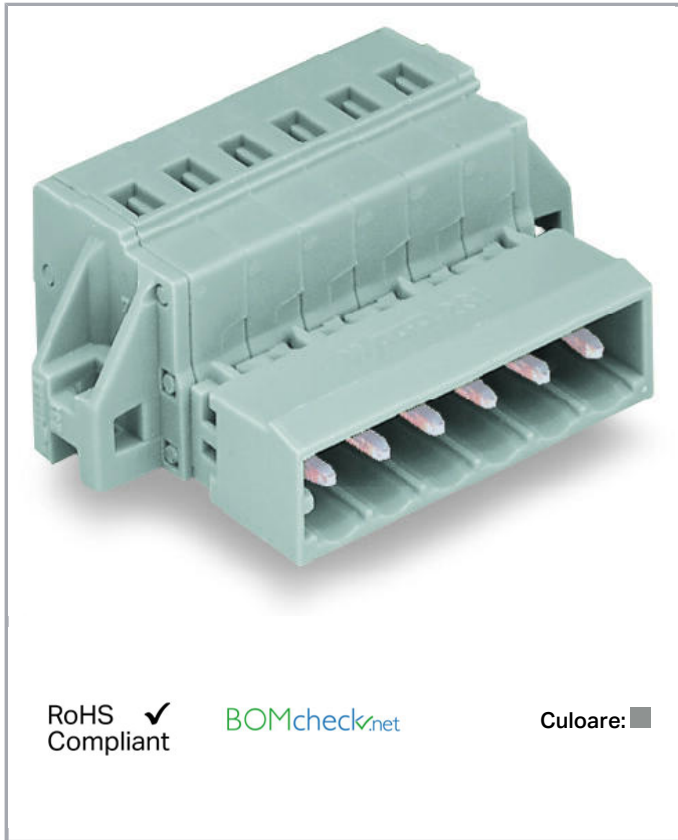

Supus modificărilor.

WAGO Kontakttechnik GmbH & Co. KG
/Representative Office Romania
Sos. Pipera-Tunari nr. 1/1
building 1, 2nd floor | 077190 Voluntari, Ilfov
Tel.: +40-(0)31 421 85 68 | Email: info-RO@wago.com

Aveți întrebări despre produsele noastre?
Vă stăm la dispoziție pentru preluarea apelului la +40 (0) 31 421 85 68.

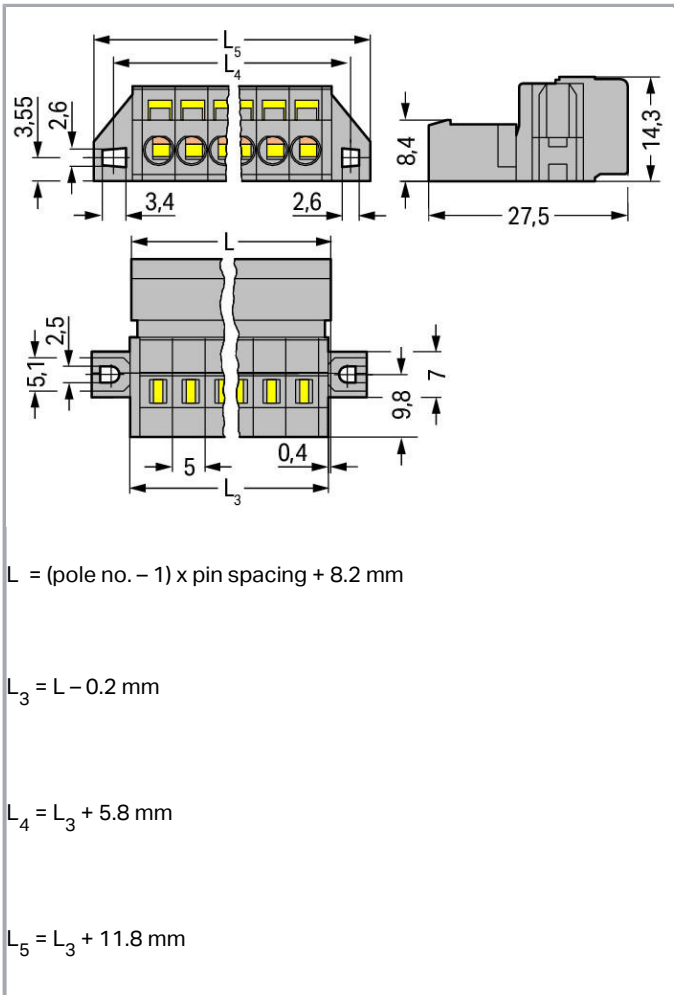

Descriere articol

- Universal connection for all conductor types
- Easy cable pre-assembly and on-unit wiring via vertical and horizontal CAGE CLAMP® actuation
- For wire-to-wire and board-to-wire connections
- Versions available with snap-in mounting feet or flanges for panel or through-panel mounting
- With coding fingers

Safety information 1:

The MCS – MULTI CONNECTION SYSTEM includes connectors without breaking capacity in accordance with DIN EN 61984. When used as intended, these connectors must not be connected/disconnected when live or under load. The circuit design should ensure header pins, which can be touched, are not live when unmated.

Supus modificărilor.

**Date****Electrical data****Ratings per IEC/EN 60664-1**

Ratings per	IEC/EN 60664-1
Nominal voltage (III/3)	320 V
Rated surge voltage (III/3)	4 kV
Rated voltage (III/2)	320 V
Rated surge voltage (III/2)	4 kV
Nominal voltage (II/2)	630 V
Rated surge voltage (II/2)	4 kV
Rated current	12 A
Legend (ratings)	(III / 2) ≙ Overvoltage category III / Pollution degree 2

Approvals per UL 1059

Rated voltage UL (Use Group B)	300 V
Rated current UL (Use Group B)	15 A
Rated voltage UL (Use Group D)	300 V
Rated current UL (Use Group D)	10 A
Approvals per	UL 1059

Approvals per UL 1977

Rated voltage UL 1977	600 V
Rated current UL 1977	15 A

Approvals per CSA

Rated voltage CSA (Use Group B)	300 V
Rated current CSA (Use Group B)	15 A
Rated voltage CSA (Use Group D)	300 V
Rated current CSA (Use Group D)	10 A

Connection data

Connection technology	CAGE CLAMP®
Actuation type	Operating tool
Solid conductor	0,08 ... 2,5 mm ² / 28 ... 12 AWG
Fine-stranded conductor	0,08 ... 2,5 mm ² / 28 ... 12 AWG

Supus modificărilor.

WAGO Kontakttechnik GmbH & Co. KG
 /Representative Office Romania
 Sos. Pipera-Tunari nr. 1/1
 building 1, 2nd floor | 077190 Voluntari, Ilfov
 Tel.: +40-(0)31 421 85 68 | Email: info-RO@wago.com

Aveți întrebări despre produsele noastre?
 Vă stăm la dispoziție pentru preluarea apelului la +40 (0) 31 421 85 68.



Fine-stranded conductor; with insulated ferrule	0,25 ... 1,5 mm ²
Fine-stranded conductor; with uninsulated ferrule	0,25 ... 2,5 mm ²
Strip length	8 ... 9 mm / 0.31 ... 0.35 inch
Pole No.	3
Total number of connection points	3
Total number of potentials	3
Number of connection types	1
Number of levels	1
Conductor entry direction to mating direction	0°

Geometrical Data

Pin spacing	5 mm / 0.197 inch
Width	29,8 mm / 1.173 inch
Height	14,3 mm / 0.563 inch
Depth	27,5 mm / 1.083 inch

Mechanical data

Mounting type	Mounting flange
Mounting type	Feed-through mounting Panel mounting

Plug connection

Contact type (pluggable connector)	Male connector/plug
Connector (connection type)	for conductor
Mismating protection	No

Material Data

Color	gray
Material group	I
Insulation material	Polyamide 66 (PA 66)
Flammability class per UL94	V0
Clamping spring material	Chrome nickel spring steel (CrNi)
Contact material	Electrolytic copper (E _{Cu})
Contact plating	tin-plated
Fire load	0,115 MJ
Weight	5,8 g

Supus modificărilor.

WAGO Kontakttechnik GmbH & Co. KG
/Representative Office Romania
Sos. Pipera-Tunari nr. 1/1
building 1, 2nd floor | 077190 Voluntari, Ilfov
Tel.: +40-(0)31 421 85 68 | Email: info-RO@wago.com

Aveți întrebări despre produsele noastre?
Vă stăm la dispoziție pentru preluarea apelului la +40 (0) 31 421 85 68.

Environmental Requirements

Limit temperature range	-60 ... +100 °C
-------------------------	-----------------

Commercial data



Product Group	3 (Multi Conn. System)
Packaging type	BOX
Country of origin	DE
GTIN	4044918256698
Customs tariff number	85366990990

Aprobări / certificate

Country specific Approvals

Emblemă	Aprobare	Text de aprobare suplimentar	Nume certificat
	CSA DEKRA Certification B.V.	C22.2	1466354

Ship Approvals

Emblemă	Aprobare	Text de aprobare suplimentar	Nume certificat
	ABS American Bureau of Shipping	-	19- HG1869876- PDA
	DNV GL Det Norske Veritas, Germanischer Lloyd	-	TAE000016Z

UL-Approvals

Emblemă	Aprobare	Text de aprobare suplimentar	Nume certificat
	UL Underwriters Laboratories Inc.	UL 1059	E45172- 19911118
	UR UL International Germany GmbH	UL 1977	E45171

Supus modificărilor.

WAGO Kontakttechnik GmbH & Co. KG
/Representative Office Romania
Sos. Pipera-Tunari nr. 1/1
building 1, 2nd floor | 077190 Voluntari, Ilfov
Tel.: +40-(0)31 421 85 68 | Email: info-RO@wago.com

Aveți întrebări despre produsele noastre?
Vă stăm la dispoziție pentru preluarea apelului la +40 (0) 31 421 85 68.



Counterpart



Nr. articol231-103/026-000

1-conductor female plug; 2.5 mm²; Pin spacing 5 mm; 3-pole; 2,50 mm²; gray

www.wago.com/231-103/026-000



Nr. articol232-133

THT female header; 0.6 x 1.0 mm solder pin; straight; Pin spacing 5 mm; 3-pole; gray

www.wago.com/232-133



Nr. articol232-233

THT female header; 0.6 x 1.0 mm solder pin; angled; Pin spacing 5 mm; 3-pole; gray

www.wago.com/232-233

Produse compatibile

Jumper



Nr. articol: 231-902

Comb-style jumper bar; for 5 mm and 5.08 mm pin spacing; reduces conductor size to 1.5 mm; gray

www.wago.com/231-902



Nr. articol: 231-903

Comb-style jumper bar; 3-way; suitable for 231 Series female connectors; with 5 mm pin spacing; insulated; gray

www.wago.com/231-903



Nr. articol: 231-905

Comb-style jumper bar; 5-way; suitable for 231 Series female connectors; with 5 mm pin spacing; insulated; gray

www.wago.com/231-905



Nr. articol: 231-907

Comb-style jumper bar; 7-way; suitable for 231 Series female connectors; with 5 mm pin spacing; insulated; gray

www.wago.com/231-907



Nr. articol: 231-910

Comb-style jumper bar; 10-way; suitable for 231 Series female connectors; with 5 mm pin spacing; insulated; gray

www.wago.com/231-910

Supus modificărilor.

General accessories



Nr. articol: 231-668
Lockout caps; for covering unused clamping units; gray

www.wago.com/231-668

Coding



Nr. articol: 231-129
Coding key; snap-on type; light gray

www.wago.com/231-129

Strain relief plate



Nr. articol: 232-603
Strain relief housing; gray

www.wago.com/232-603

assembling



Nr. articol: 209-147
Self-tapping screw

www.wago.com/209-147

Nr. articol: 231-194
Self-tapping screw; B 2.2x13, fixing hole 1.8 mm Ø

www.wago.com/231-194

Nr. articol: 231-195
Screw with nut; M2x12; for fixing element

www.wago.com/231-195

Nr. articol: 231-295
Screw with nut

www.wago.com/231-295

Insulation stop



Nr. articol: 231-670
Insulation stop; 0.08-0.2 mm² / 0.2 mm² "s"; white

www.wago.com/231-670

Nr. articol: 231-671
Insulation stop; 0.25 - 0.5 mm²; light gray

www.wago.com/231-671

Nr. articol: 231-672
Insulation stop; 0.75 - 1 mm²; dark gray

www.wago.com/231-672

tools



Nr. articol: 209-130
Operating tool; suitable for 264, 280 and 281 Series; 1-way; of insulating material

www.wago.com/209-130

Nr. articol: 209-132
Operating tool; for connecting comb-style jumper bar; 2-way; of insulating material

www.wago.com/209-132

Nr. articol: 210-250
Operating tool; for MCS MINI & MIDI with CAGE CLAMP® connection; red

www.wago.com/210-250













Nr. articol: 210-657
Operating tool; Blade: 3.5 x 0.5 mm; with a partially insulated shaft; short

www.wago.com/210-657

Nr. articol: 210-720
Operating tool; Blade: 3.5 x 0.5 mm; with a partially insulated shaft

www.wago.com/210-720

Supus modificărilor.

	Nr. articol: 231-131 Push-button; loose	www.wago.com/231-131
	Nr. articol: 231-159 Operating tool; natural	www.wago.com/231-159
	Nr. articol: 231-231 Combination operating tool; red	www.wago.com/231-231
	Nr. articol: 231-291 Operating tool; loose; red	www.wago.com/231-291
	Nr. articol: 280-432 Operating tool; made of insulating material; 2-way	www.wago.com/280-432
	Nr. articol: 280-433 Operating tool; made of insulating material; 3-way	www.wago.com/280-433
	Nr. articol: 280-434 Operating tool; made of insulating material; 4-way	www.wago.com/280-434
	Nr. articol: 280-435 Operating tool; made of insulating material; 5-way; gray	www.wago.com/280-435
	Nr. articol: 280-436 Operating tool; made of insulating material; 6-way	www.wago.com/280-436
	Nr. articol: 280-437 Operating tool; made of insulating material; 7-way	www.wago.com/280-437
	Nr. articol: 280-438 Operating tool; made of insulating material; 8-way	www.wago.com/280-438
	Nr. articol: 280-440 Operating tool; made of insulating material; 10-way	www.wago.com/280-440

Marking accessories

Nr. articol: 210-331/500-103 Marking strips; as a DIN A4 sheet; MARKED; 1-12 (300x); Height of marker strip: 2.3 mm/0.091 in; Strip length 182 mm; Horizontal marking; Self-adhesive; white	www.wago.com/210-331/500-103
Nr. articol: 210-331/500-104 Marking strips; as a DIN A4 sheet; MARKED; 13-24 (300x); Height of marker strip: 2.3 mm/0.091 in; Strip length 182 mm; Horizontal marking; Self-adhesive; white	www.wago.com/210-331/500-104
Nr. articol: 210-332/500-202 Marking strips; as a DIN A4 sheet; MARKED; 1-16 (160x); Height of marker strip: 3 mm; Strip length 182 mm; Horizontal marking; Self-adhesive; white	www.wago.com/210-332/500-202
Nr. articol: 210-332/500-204 Marking strips; as a DIN A4 sheet; MARKED; 17-32 (160x); Height of marker strip: 3 mm; Strip length 182 mm; Horizontal marking; Self-adhesive; white	www.wago.com/210-332/500-204
Nr. articol: 210-332/500-205	

Supus modificărilor.

Marking strips; as a DIN A4 sheet; MARKED; 1-32 (80x); Height of marker strip: 3 mm; Strip length 182 mm; Horizontal marking; Self-adhesive; white www.wago.com/210-332/500-205

Nr. articol: 210-332/500-206

Marking strips; as a DIN A4 sheet; MARKED; 33-48 (160x); Height of marker strip: 3 mm; Strip length 182 mm; Horizontal marking; Self-adhesive; white www.wago.com/210-332/500-206

**Nr. articol: 210-833**

Marking strips; on reel; 6 mm wide; plain; Self-adhesive; white

www.wago.com/210-833

**Nr. articol: 210-834**

Marking strips; on reel; 5 mm wide; plain; Self-adhesive; white

www.wago.com/210-834

ferrule**Nr. articol: 216-101**

Ferrule; Sleeve for 0.5 mm² / AWG 22; uninsulated; electro-tin plated

www.wago.com/216-101

**Nr. articol: 216-102**

Ferrule; Sleeve for 0.75 mm² / AWG 20; uninsulated; electro-tin plated

www.wago.com/216-102

**Nr. articol: 216-103**

Ferrule; Sleeve for 1 mm² / AWG 18; uninsulated; electro-tin plated

www.wago.com/216-103

**Nr. articol: 216-104**

Ferrule; Sleeve for 1.5 mm² / AWG 16; uninsulated; electro-tin plated

www.wago.com/216-104

**Nr. articol: 216-106**

Ferrule; Sleeve for 2.5 mm² / AWG 14; uninsulated; electro-tin plated

www.wago.com/216-106

**Nr. articol: 216-121**

Ferrule; Sleeve for 0.5 mm² / AWG 22; uninsulated; electro-tin plated

www.wago.com/216-121

**Nr. articol: 216-122**

Ferrule; Sleeve for 0.75 mm² / AWG 20; uninsulated; electro-tin plated

www.wago.com/216-122

**Nr. articol: 216-123**

Ferrule; Sleeve for 1 mm² / AWG 18; uninsulated; electro-tin plated

www.wago.com/216-123

**Nr. articol: 216-124**

Ferrule; Sleeve for 1.5 mm² / AWG 16; uninsulated; electro-tin plated

www.wago.com/216-124

**Nr. articol: 216-131**

Ferrule; Sleeve for 0.25 mm² / AWG 24; uninsulated; electro-tin plated

www.wago.com/216-131

**Nr. articol: 216-132**

Ferrule; Sleeve for 0.34 mm² / AWG 24; uninsulated; electro-tin plated

www.wago.com/216-132

**Nr. articol: 216-141**

Ferrule; Sleeve for 0.5 mm² / 20 AWG; uninsulated; electro-tin plated; electrolytic copper; gastight crimped; acc. to DIN 46228, Part 1/08.92 www.wago.com/216-141

















**Nr. articol: 216-142**

Ferrule; Sleeve for 0.75 mm² / 18 AWG; uninsulated; electro-tin plated; electrolytic copper; gastight crimped; acc. to DIN 46228, Part 1/08.92 www.wago.com/216-142

Supus modificărilor.

WAGO Kontakttechnik GmbH & Co. KG
/Representative Office Romania
Sos. Pipera-Tunari nr. 1/1
building 1, 2nd floor | 077190 Voluntari, Ilfov
Tel.: +40-(0)31 421 85 68 | Email: info-RO@wago.com





Aveți întrebări despre produsele noastre?
Vă stăm la dispoziție pentru preluarea apelului la +40 (0) 31 421 85 68.

	Nr. articol: 216-143 Ferrule; Sleeve for 1 mm ² / AWG 18; uninsulated; electro-tin plated; electrolytic copper; gastight crimped; acc. to DIN 46228, Part 1/08.92	www.wago.com/216-143
	Nr. articol: 216-144 Ferrule; Sleeve for 1.5 mm ² / AWG 16; uninsulated; electro-tin plated; electrolytic copper; gastight crimped; acc. to DIN 46228, Part 1/08.92	www.wago.com/216-144
	Nr. articol: 216-151 Ferrule; Sleeve for 0.25 mm ² / AWG 24; uninsulated; electro-tin plated	www.wago.com/216-151
	Nr. articol: 216-152 Ferrule; Sleeve for 0.34 mm ² / AWG 24; uninsulated; electro-tin plated	www.wago.com/216-152
	Nr. articol: 216-201 Ferrule; Sleeve for 0.5 mm ² / 20 AWG; insulated; electro-tin plated; white	www.wago.com/216-201
	Nr. articol: 216-202 Ferrule; Sleeve for 0.75 mm ² / 18 AWG; insulated; electro-tin plated; gray	www.wago.com/216-202
	Nr. articol: 216-203 Ferrule; Sleeve for 1 mm ² / AWG 18; insulated; electro-tin plated; red	www.wago.com/216-203
	Nr. articol: 216-204 Ferrule; Sleeve for 1.5 mm ² / AWG 16; insulated; electro-tin plated; black	www.wago.com/216-204
	Nr. articol: 216-221 Ferrule; Sleeve for 0.5 mm ² / 20 AWG; insulated; electro-tin plated; white	www.wago.com/216-221
	Nr. articol: 216-222 Ferrule; Sleeve for 0.75 mm ² / 18 AWG; insulated; electro-tin plated; gray	www.wago.com/216-222
	Nr. articol: 216-223 Ferrule; Sleeve for 1 mm ² / AWG 18; insulated; electro-tin plated; red	www.wago.com/216-223
	Nr. articol: 216-224 Ferrule; Sleeve for 1.5 mm ² / AWG 16; insulated; electro-tin plated; black	www.wago.com/216-224
	Nr. articol: 216-241 Ferrule; Sleeve for 0.5 mm ² / 20 AWG; insulated; electro-tin plated; electrolytic copper; gastight crimped; acc. to DIN 46228, Part 4/09.90; white	www.wago.com/216-241
	Nr. articol: 216-242 Ferrule; Sleeve for 0.75 mm ² / 18 AWG; insulated; electro-tin plated; electrolytic copper; gastight crimped; acc. to DIN 46228, Part 4/09.90; gray	www.wago.com/216-242
	Nr. articol: 216-243 Ferrule; Sleeve for 1 mm ² / AWG 18; insulated; electro-tin plated; electrolytic copper; gastight crimped; acc. to DIN 46228, Part 4/09.90; red	www.wago.com/216-243
	Nr. articol: 216-244 Ferrule; Sleeve for 1.5 mm ² / AWG 16; insulated; electro-tin plated; electrolytic copper; gastight crimped; acc. to DIN 46228, Part 4/09.90; black	www.wago.com/216-244
	Nr. articol: 216-262 Ferrule; Sleeve for 0.75 mm ² / 18 AWG; insulated; electro-tin plated; electrolytic copper; gastight crimped; acc. to DIN 46228, Part 4/09.90; gray	www.wago.com/216-262

Supus modificărilor.

WAGO Kontakttechnik GmbH & Co. KG
/Representative Office Romania
Sos. Pipera-Tunari nr. 1/1
building 1, 2nd floor | 077190 Voluntari, Ilfov
Tel.: +40-(0)31 421 85 68 | Email: info-RO@wago.com

Aveți întrebări despre produsele noastre?
Vă stăm la dispoziție pentru preluarea apelului la +40 (0) 31 421 85 68.

	Nr. articol: 216-263 Ferrule; Sleeve for 1 mm ² / AWG 18; insulated; electro-tin plated; electrolytic copper; gastight crimped; acc. to DIN 46228, Part 4/09.90; red	www.wago.com/216-263
	Nr. articol: 216-264 Ferrule; Sleeve for 1.5 mm ² / AWG 16; insulated; electro-tin plated; electrolytic copper; gastight crimped; acc. to DIN 46228, Part 4/09.90; black	www.wago.com/216-264
	Nr. articol: 216-284 Ferrule; Sleeve for 1.5 mm ² / AWG 16; insulated; electro-tin plated; electrolytic copper; gastight crimped; acc. to DIN 46228, Part 4/09.90; black	www.wago.com/216-284
	Nr. articol: 216-301 Ferrule; Sleeve for 0.25 mm ² / AWG 24; insulated; electro-tin plated; yellow	www.wago.com/216-301
	Nr. articol: 216-302 Ferrule; Sleeve for 0.34 mm ² / 22 AWG; insulated; electro-tin plated; green	www.wago.com/216-302
	Nr. articol: 216-321 Ferrule; Sleeve for 0.25 mm ² / AWG 24; insulated; electro-tin plated; yellow	www.wago.com/216-321
	Nr. articol: 216-322 Ferrule; Sleeve for 0.34 mm ² / 22 AWG; insulated; electro-tin plated; green	www.wago.com/216-322

Descărcări

Documentation

Additional Information

Technical explanations	Apr 3, 2019	pdf 3,6 MB	Descărcare
------------------------	-------------	---------------	------------

CAD/CAE-Data

CAD data

2D/3D Models 231-603/019-000	URL	Descărcare
------------------------------	-----	------------

CAE data

EPLAN Data Portal 231-603/019-000	URL	Descărcare
-----------------------------------	-----	------------

Installation Notes

Inserting a conductor

Supus modificărilor.



Inserting a conductor via 3.5 mm screwdriver – CAGE CLAMP® actuation parallel to conductor entry.



Inserting a conductor via 3.5 mm screwdriver – CAGE CLAMP® actuation perpendicular to conductor entry.



Inserting a conductor into CAGE CLAMP® unit via operating lever (231-291).



Inserting a conductor via operating tool.

Coding

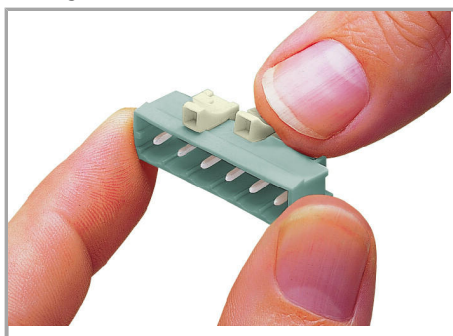

Coding a male header – fitting coding key(s).

Testing

Supus modificărilor.

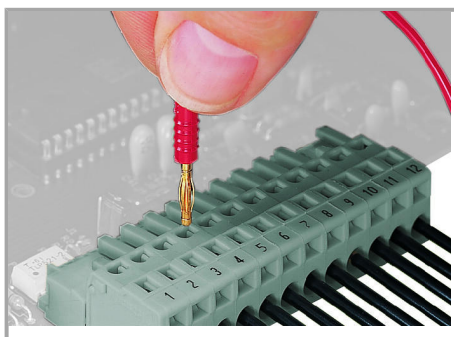

Testing perpendicular to conductor entry via 2 or 2.3 mm Ø test plug – female connector with CAGE CLAMP®.

Assembly



Male connector with strain relief plate



Strain relief housing shown with a male connector equipped with CAGE CLAMP®

Marking

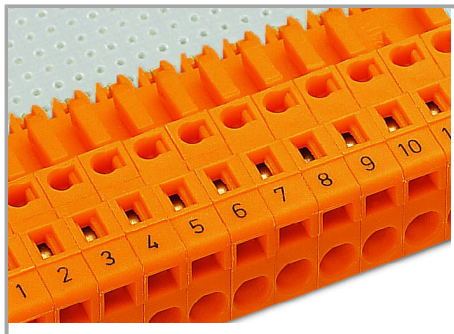

Labeling via direct marking or self-adhesive strips.

Familie de produse

Supus modificărilor.



MCS MIDI Classic

Afișare globală produse din familie.

Supus modificărilor.

WAGO Kontakttechnik GmbH & Co. KG
/Representative Office Romania
Sos. Pipera-Tunari nr. 1/1
building 1, 2nd floor | 077190 Voluntari, Ilfov
Tel.: +40-(0)31 421 85 68 | Email: info-RO@wago.com

Aveți întrebări despre produsele noastre?
Vă stăm la dispoziție pentru preluarea apelului la +40 (0) 31 421 85 68.