

Fișă tehnică | Număr articol: 770-2115/007-000

Snap-in plug; with direct ground contact; 5-pole; Cod. I; 4,00 mm²; blue

www.wago.com/770-2115/007-000

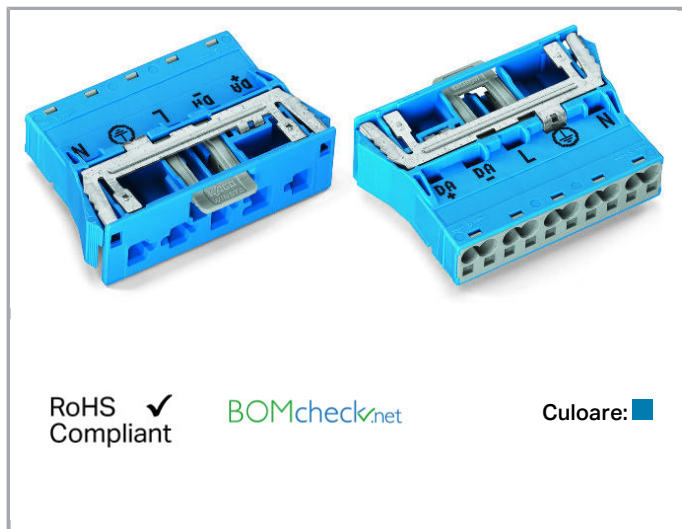

RoHS
Compliant ✓

[BOMcheck.net](https://www.bomcheck.net)

Culoare: ■

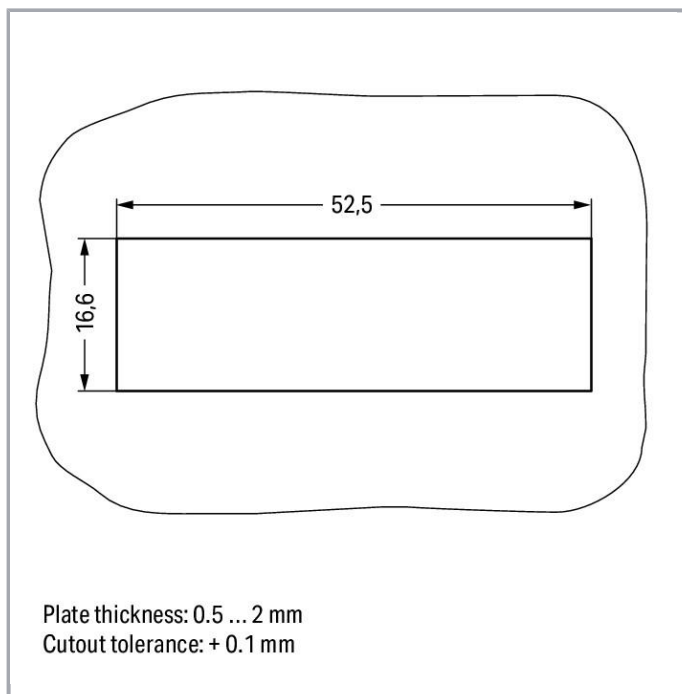
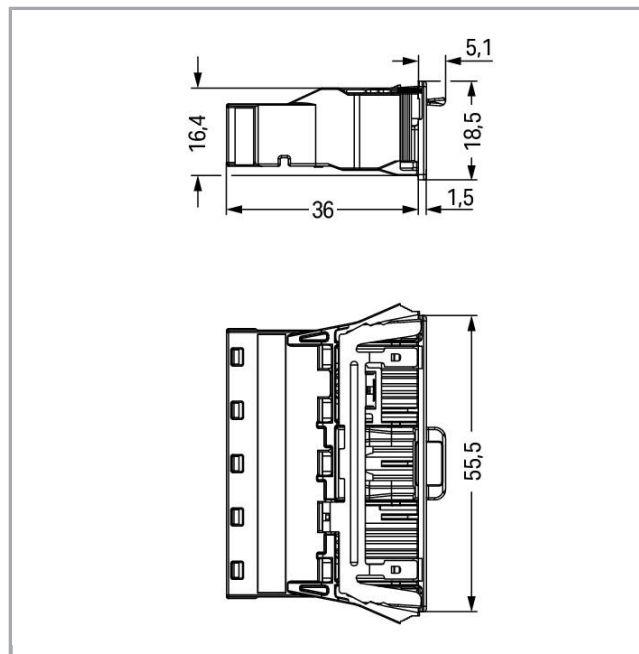

Plate thickness: 0.5 ... 2 mm
Cutout tolerance: + 0.1 mm

Supus modificărilor.

WAGO Kontakttechnik GmbH & Co. KG
/Representative Office Romania
Sos. Pipera-Tunari nr. 1/1
building 1, 2nd floor | 077190 Voluntari, Ilfov
Tel.: +40-(0)31 421 85 68 | Email: info-RO@wago.com

Aveți întrebări despre produsele noastre?
Vă stăm la dispoziție pentru preluarea apelului la +40 (0) 31 421 85 68.



Descriere articol

- Protected against mismatching and maintenance-free
- Push-in CAGE CLAMP® spring pressure connection technology allows solid conductors to be simply pushed into a unit
- Two-wire connection per pole for loops or bridges
- Additional variable coding is possible

Note:

All connectors for mounted installations (snap-in versions for lighting fixtures or devices, all types of PCB and distribution connectors) are factory-equipped with locking levers to ensure plugs and sockets are securely locked. Additional locking levers are only required for flying leads (plug /socket).

Note on mismatching protection:

All WINSTA® components are 100% protected against mismatching when:

- plugging different numbers of poles
- plugging while rotated 180
- plugging while laterally staggered
- plugging one pole

Safety information 1:

Application note for the U.S. market (USR): Some versions may also be used for current interruption in accordance with the UL certificate in select applications with currents below 16 A and voltages up to 600 V. For further information, please contact your local sales office.

Date

Electrical data

Note on Contact Resistance

approx. 1 mΩ of contact resistance approx. 0.25 mΩ contact transition plug/socket

Ratings per IEC/EN 60664-1

| Ratings per | IEC/EN 60664-1 |
|-----------------------------|---|
| Nominal voltage (III/3) | 400 V |
| Rated surge voltage (III/3) | 6 kV |
| Rated current | 25 A |
| Legend (ratings) | (III / 3) ≙ Overvoltage category III / Pollution degree 3 |

Approvals per UL 1977

| | |
|-----------------------|-------|
| Rated voltage UL 1977 | 600 V |
| Rated current UL 1977 | 23 A |

Connection data

Connection technology

Supus modificărilor.

WAGO Kontakttechnik GmbH & Co. KG
/Representative Office Romania
Sos. Pipera-Tunari nr. 1/1
building 1, 2nd floor | 077190 Voluntari, Ilfov
Tel.: +40-(0)31 421 85 68 | Email: info-RO@wago.com

Aveți întrebări despre produsele noastre?
Vă stăm la dispoziție pentru preluarea apelului la +40 (0) 31 421 85 68.



| Push-in CAGE CLAMP® | |
|--|--|
| Actuation type | Operating tool Push-in |
| Nominal cross-section | 4 mm ² |
| Solid conductor | 0,5 ... 4 mm ² / 20 ... 12 AWG |
| Solid conductor; push-in termination | 1,5 ... 4 mm ² / 16 ... 12 AWG |
| Stranded conductor | 0,5 ... 2,5 mm ² / 20 ... 14 AWG |
| Fine-stranded conductor | 0,5 ... 4 mm ² / 20 ... 12 AWG |
| Fine-stranded conductor; with insulated ferrule | 0,25 ... 1,5 mm ² / 20 ... 16 AWG |
| Fine-stranded conductor; with uninsulated ferrule | 0,25 ... 2,5 mm ² / 20 ... 14 AWG |
| Fine-stranded conductor; with ferrule; push-in termination | 1,5 mm ² / 16 AWG |
| Strip length | 9 mm / 0.35 inch |
| Note (strip length) | see also packaging or instructions |
| Pole No. | 5 |
| Total number of connection points | 10 |
| Total number of potentials | 5 |
| Ground function | with preceding ground contact |
| Conductor entry direction to mating direction | 0° |

Geometrical Data

| | |
|-------------|----------------------|
| Pin spacing | 10 mm / 0.394 inch |
| Width | 55,5 mm / 2.185 inch |
| Height | 18,5 mm / 0.728 inch |
| Depth | 36 mm / 1.417 inch |

Mechanical data

| | |
|---|--|
| Technologie | DALI |
| Coding | I |
| Mating force of a plug-in connection | approx. 20 ... 70 N (depending on pole number) |
| Retention force of a plug-in connection | Locked: > 80 N |
| Unmating force of a plug-in connection | Unlocked: approx. 20 ... 70 N (depending on pole number) |
| Number of mating cycles | 200, without resistive load 100, with resistive load $I_N = 25$ A, tested (4 mm ² /AWG 12) |
| Housing sheet thickness | 0,5 ... 2 mm / 0.02 ... 0.079 inch |

Supus modificărilor.

WAGO Kontakttechnik GmbH & Co. KG
/Representative Office Romania
Sos. Pipera-Tunari nr. 1/1
building 1, 2nd floor | 077190 Voluntari, Ilfov
Tel.: +40-(0)31 421 85 68 | Email: info-RO@wago.com

Aveți întrebări despre produsele noastre?
Vă stăm la dispoziție pentru preluarea apelului la +40 (0) 31 421 85 68.



| | |
|--|---|
| Direct ground contact to DIN-rail/drilled hole/housing | 1 |
| Design | with direct ground contact |
| Mounting type | Snap-in |
| Marking | N L DA- DA+ |
| Protection type | IP20 |
| Note on protection type | Only when mated (these compact connectors are not designed for use in open, easily accessible areas). |
| Potential marking | N L DA- DA+ |
| Application | Lighting management |

Plug connection

| | |
|------------------------------------|---------------------|
| Contact type (pluggable connector) | Male connector/plug |
| Connector (connection type) | for conductor |
| Mismating protection | Yes |
| Locking of plug-in connection | locking lever |
| Locking lever | yes |

Material Data

| | |
|--------------------------|--|
| Color | blue |
| Insulation material | Polyamide 66 (PA 66) |
| Clamping spring material | Chrome nickel spring steel (CrNi) |
| Contact material | Copper or copper alloy (surface-treated) |
| Fire load | 0,382 MJ |
| Weight | 20,9 g |

Environmental Requirements

| | |
|--|---|
| Processing temperature | -5 ... +40 °C |
| Continuous operating temperature | -35 ... +85 °C |
| Note on continuous operating temperature | Insulating parts for temperatures ≤ 105 °C |

Commercial data

| | |
|-----------------------|---------------|
| Packaging type | BOX |
| Country of origin | DE |
| GTIN | 4055143594752 |
| Customs tariff number | 85366990990 |

Aprobări / certificate

Supus modificărilor.



WAGO Kontakttechnik GmbH & Co. KG
 /Representative Office Romania
 Sos. Pipera-Tunari nr. 1/1
 building 1, 2nd floor | 077190 Voluntari, Ilfov
 Tel.: +40-(0)31 421 85 68 | Email: info-RO@wago.com

Aveți întrebări despre produsele noastre?
 Vă stăm la dispoziție pentru preluarea apelului la +40 (0) 31 421 85 68.

Country specific Approvals

| Emblemă | Aprobare | Text de aprobare suplimentar | Nume certificat |
|--|--|------------------------------|-----------------|
|  | CCA DEKRA Certification B.V. | EN 61535 | 2173495.02 |





Ship Approvals

| Emblemă | Aprobare | Text de aprobare suplimentar | Nume certificat |
|--|---|------------------------------|--------------------------|
|  | ABS American Bureau of Shipping | - | 19- HG1868589- PDA |
|  | DNV GL Det Norske Veritas, Germanischer Lloyd | - | TAE00001Z6 |
|  | LR Lloyds Register | IEC 61984 | 02/20050 (E6) |

UL-Approvals

| Emblemă | Aprobare | Text de aprobare suplimentar | Nume certificat |
|--|--|------------------------------|------------------|
|  | cURus Underwriters Laboratories Inc. | UL 1977 | E45171 Sec. 9 |

Counterpart

| | | |
|--|--|--|
|  | Nr. articol770-1105 Socket; 5-pole; Cod. I; 4,00 mm ² ; blue | www.wago.com/770-1105 |
|  | Nr. articol770-1105/022-000 Socket; with strain relief housing; 5-pole; Cod. I; 4,00 mm ² ; blue | www.wago.com/770-1105/022-000 |
|  | Nr. articol771-9985/006-101 pre-assembled interconnecting cable; Eca; Socket/plug; 5-pole; Cod. I; H05VV-F 5G 1.5 mm ² ; 1 m; 1,50 mm ² ; blue | www.wago.com/771-9985/006-101 |
|  | Nr. articol771-9985/106-101 | www.wago.com/771-9985 |

Supus modificărilor.

WAGO Kontakttechnik GmbH & Co. KG
/Representative Office Romania
Sos. Pipera-Tunari nr. 1/1
building 1, 2nd floor | 077190 Voluntari, Ilfov
Tel.: +40-(0)31 421 85 68 | Email: info-RO@wago.com

Aveți întrebări despre produsele noastre?
Vă stăm la dispoziție pentru preluarea apelului la +40 (0) 31 421 85 68.

pre-assembled connecting cable; Eca; Socket/open-ended; 5-pole; Cod. I; H05VV-F 5G 1.5 mm²; 1 /106-101
m; 1,50 mm²; blue

Produse compatibile

tools



Nr. articol: 210-719

Operating tool; Blade: 2.5 x 0.4 mm; with a partially insulated shaft

www.wago.com/210-719

Descărcări

CAD/CAE-Data

CAE data

EPLAN Data Portal 770-2115/007-000

URL

Descărcare

WSCAD Universe 770-2115/007-000

URL

Descărcare

Installation Notes

Conductor termination

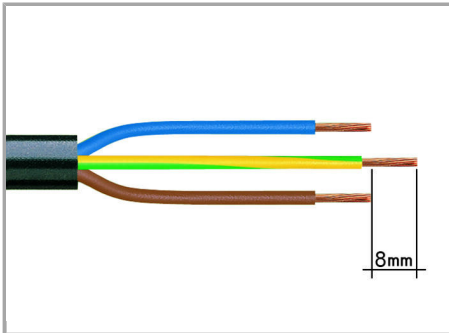

1. Strip length, outer insulation = 35 mm (2-pole), 55 mm (3- to 5-pole)

2. Strip length = 9 mm

3. Extended ground conductor = 8 mm

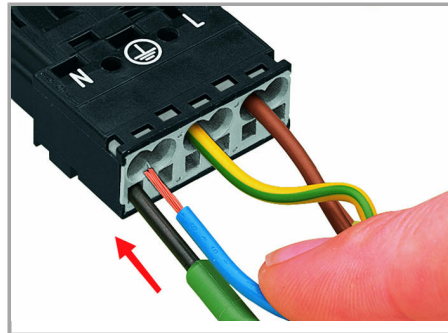

To terminate fine-stranded conductors, open the clamping unit via screwdriver (2.5 mm blade width) and insert stripped conductor until it hits backstop.

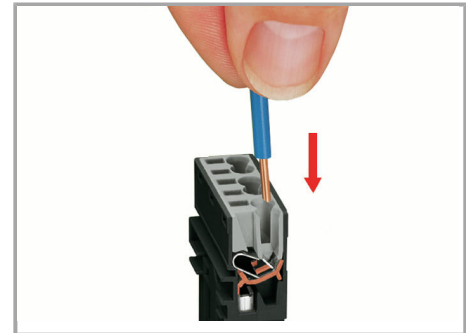

Insert stripped solid conductor until it hits backstop.

Supus modificărilor.

WAGO Kontakttechnik GmbH & Co. KG
/Representative Office Romania
Sos. Pipera-Tunari nr. 1/1
building 1, 2nd floor | 077190 Voluntari, Ilfov
Tel.: +40-(0)31 421 85 68 | Email: info-RO@wago.com

Aveți întrebări despre produsele noastre?
Vă stăm la dispoziție pentru preluarea apelului la +40 (0) 31 421 85 68.

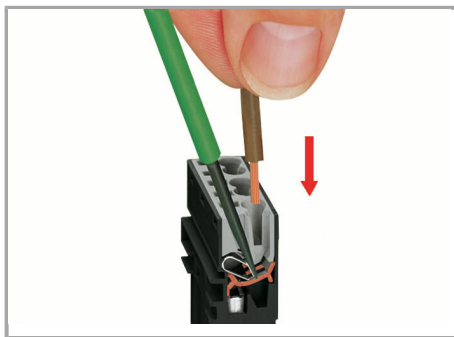

To terminate fine-stranded conductors, open the clamping unit via screwdriver (2.5 mm blade width) and insert stripped conductor until it hits backstop.

Conductor removal

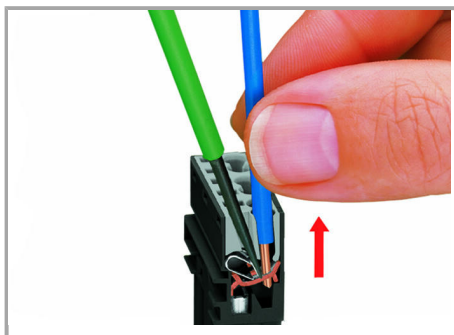

To remove the conductor, actuate the clamp via screwdriver (2.5 mm blade width) and pull out the conductor.

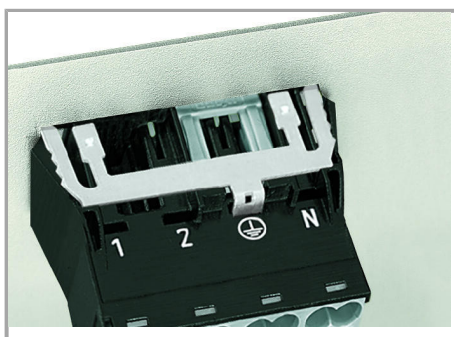

Varnish-piercing direct ground contact

Familie de produse

Supus modificărilor.

WAGO Kontakttechnik GmbH & Co. KG
/Representative Office Romania
Sos. Pipera-Tunari nr. 1/1
building 1, 2nd floor | 077190 Voluntari, Ilfov
Tel.: +40-(0)31 421 85 68 | Email: info-RO@wago.com

Aveți întrebări despre produsele noastre?
Vă stăm la dispoziție pentru preluarea apelului la +40 (0) 31 421 85 68.



WINSTA® MIDI

Afișare globală produse din familie.

Supus modificărilor.

WAGO Kontakttechnik GmbH & Co. KG
/Representative Office Romania
Sos. Pipera-Tunari nr. 1/1
building 1, 2nd floor | 077190 Voluntari, Ilfov
Tel.: +40-(0)31 421 85 68 | Email: info-RO@wago.com

Aveți întrebări despre produsele noastre?
Vă stăm la dispoziție pentru preluarea apelului la +40 (0) 31 421 85 68.