

Fișă tehnică | Număr articol: 771-8965/017-202

pre-assembled interconnecting cable; Eca; Distribution connector with phase selection/plug; 5-pole; Cod. A; H05Z1Z1-F 5G 2.5 mm²; 2 m; 2,50 mm²; white

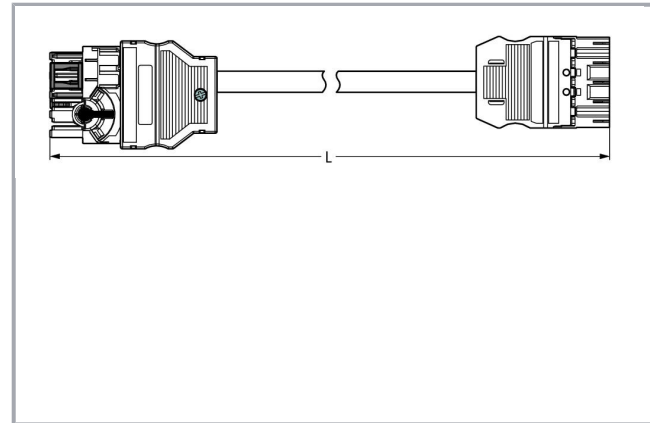

www.wago.com/771-8965/017-202

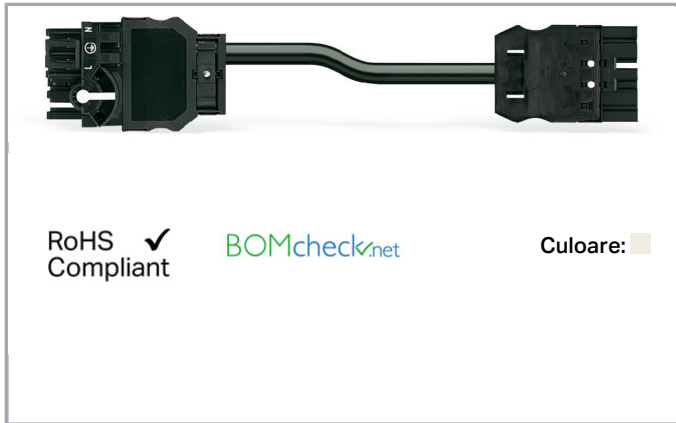

Descriere articol

- Protected against mismatching and maintenance-free
- Additional variable coding is possible

Note:

Cables with a different fire class can be found in the eShop.

Note on mismatching protection:

All WINSTA[®] components are 100% protected against mismatching when:

- plugging different numbers of poles
- plugging while rotated 180
- plugging while laterally staggered
- plugging one pole

Safety information 1:

Application note for the U.S. market (USR): Some versions may also be used for current interruption in accordance with the UL certificate in select applications with currents below 16 A and voltages up to 600 V. For further information, please contact your local sales office.

Date

Electrical data

Note on Contact Resistance

approx. 1 mΩ of contact resistance approx. 0.25 mΩ contact transition plug/socket

Supus modificărilor.

WAGO Kontakttechnik GmbH & Co. KG
/Representative Office Romania
Sos. Pipera-Tunari nr. 1/1
building 1, 2nd floor | 077190 Voluntari, Ilfov
Tel.: +40-(0)31 421 85 68 | Email: info-RO@wago.com

Aveți întrebări despre produsele noastre?
Vă stăm la dispoziție pentru preluarea apelului la +40 (0) 31 421 85 68.



Ratings per IEC/EN 60664-1

Ratings per	IEC/EN 60664-1
Nominal voltage (III/3)	400 V
Rated surge voltage (III/3)	6 kV
Rated current	20 A
Legend (ratings)	(III / 3) ≙ Overvoltage category III / Pollution degree 3

Approvals per UL 1977

Rated voltage UL 1977	600 V
Rated current UL 1977	23 A

Connection data

Pole No.	5
Total number of potentials	5
Sheathed cable diameter	11,2 ... 13,9 mm
Wire cross-section	2,5 mm ²
Strip length (outer insulation)	55 mm
Connection type	Distribution connector with phase selection - Plug

Geometrical Data

Pin spacing	10 mm / 0.394 inch
Total length	2 m

Mechanical data

Mating force of a plug-in connection	approx. 20 ... 70 N (depending on pole number)
Retention force of a plug-in connection	when locked: > 80N
Unmating force of a plug-in connection	when unlocked: approx. 20 ... 70 N (depending on pole number)
Number of mating cycles	200 (without resistive load) 100 (with resistive load $I_N = 25$ A), tested (4 mm ²)
Connection type	Distribution connector with phase selection - Plug
Type of pre-assembled cable	Interconnecting cable
Cable type	H05Z1Z1-F 5G2.5
Marking	L N
Protection type	IP20
Note on protection type	Only when mated (these compact connectors are not designed for use in open, easily accessible areas).

Supus modificărilor.

WAGO Kontakttechnik GmbH & Co. KG
 /Representative Office Romania
 Sos. Pipera-Tunari nr. 1/1
 building 1, 2nd floor | 077190 Voluntari, Ilfov
 Tel.: +40-(0)31 421 85 68 | Email: info-RO@wago.com

Aveți întrebări despre produsele noastre?
 Vă stăm la dispoziție pentru preluarea apelului la +40 (0) 31 421 85 68.



Potential marking	L N
Application	General mains applications

Plug connection

Mismating protection	Yes
Locking of plug-in connection	locking lever
Locking lever	retrofitable

Material Data

Color	white
Insulation material	Polyamide 66 (PA 66)
Fire class per EN 50575	E _{ca}
Contact material	Copper or copper alloy (surface-treated)
Fire load	7,868 MJ
Connector color	white
Printing color of mating face	black
Strain relief color	white
Printing color of strain relief	black
Sheathed cable color	white
Printing color of sheathed cable	black
Halogen-free	Yes
Weight	532,9 g

Environmental Requirements

Processing temperature	-5 ... +40 °C
Continuous operating temperature	-35 ... +85 °C
Note on continuous operating temperature	PVC cable for temperatures ≤ 70 °C (including halogen-free) Insulating parts for temperatures ≤ 105 °C

Commercial data

Packaging type	not packed
Country of origin	DE
GTIN	4045454559656
Customs tariff number	85444290900



Supus modificărilor.

WAGO Kontakttechnik GmbH & Co. KG
/Representative Office Romania
Sos. Pipera-Tunari nr. 1/1
building 1, 2nd floor | 077190 Voluntari, Ilfov
Tel.: +40-(0)31 421 85 68 | Email: info-RO@wago.com

Aveți întrebări despre produsele noastre?
Vă stăm la dispoziție pentru preluarea apelului la +40 (0) 31 421 85 68.

Aprobări / certificate







Country specific Approvals

Emblemă	Aprobare	Text de aprobare suplimentar	Nume certificat
	CCA DEKRA Certification B.V.	EN 61535	NTR NL-7355
	KEMA/KEUR DEKRA Certification B.V.	EN 61535	2179129.01

Counterpart

Produse compatibile

Marking accessories

	Nr. articol: 210-334 Marking strips; as a DIN A4 sheet; Strip width 5 mm; Strip length 182 mm; plain; Self-adhesive; white	www.wago.com/210-334
	Nr. articol: 770-450 Marker card; Plastic; white	www.wago.com/770-450
	Nr. articol: 770-450/000-001 Marker card; Plastic; white	www.wago.com/770-450/000-001
	Nr. articol: 770-450/000-002 Marker card; Plastic; white	www.wago.com/770-450/000-002
	Nr. articol: 770-450/000-005 Marker card; Plastic; white	www.wago.com/770-450/000-005
	Nr. articol: 770-450/000-006 Marker card; Plastic; white	www.wago.com/770-450/000-006
	Nr. articol: 770-450/000-012 Marker card; Plastic; white	www.wago.com/770-450/000-012

Supus modificărilor.

WAGO Kontakttechnik GmbH & Co. KG
/Representative Office Romania
Sos. Pipera-Tunari nr. 1/1
building 1, 2nd floor | 077190 Voluntari, Ilfov
Tel.: +40-(0)31 421 85 68 | Email: info-RO@wago.com

Aveți întrebări despre produsele noastre?
Vă stăm la dispoziție pentru preluarea apelului la +40 (0) 31 421 85 68.

protection



Nr. articol: 770-201

Lockout cap; 12-pole, separable; 12-pole; for sockets; black

www.wago.com/770-201



Nr. articol: 770-221

Lockout cap; for socket; 12-pole; separable; white

www.wago.com/770-221



Nr. articol: 770-360

Lockout cap; for plugs; 5-pole; separable; yellow

www.wago.com/770-360

Descărcări

CAD/CAE-Data

CAE data

WSCAD Universe 771-8965/017-202

URL

Descărcare

Installation Notes

Familie de produse

<i>WINSTA</i>® MIDI

Afișare globală produse din familie.

Supus modificărilor.