

Fișă tehnică | Număr articol: 771-8965/017-101

pre-assembled interconnecting cable; Eca; Distribution connector with phase selection/plug; 5-pole; Cod. A; H05Z1Z1-F 5G 2.5 mm²; 1 m; 2,50 mm²; black

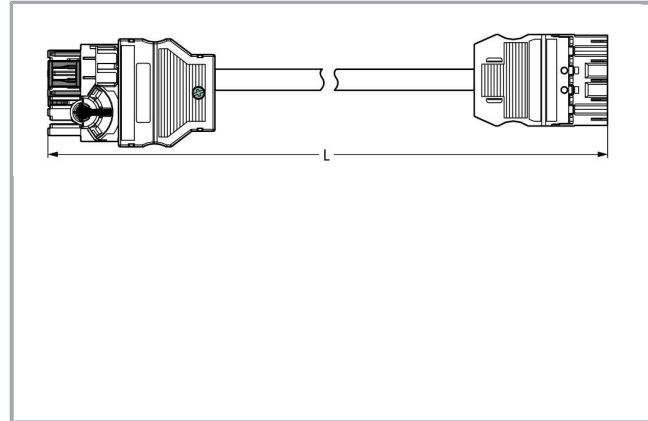

www.wago.com/771-8965/017-101

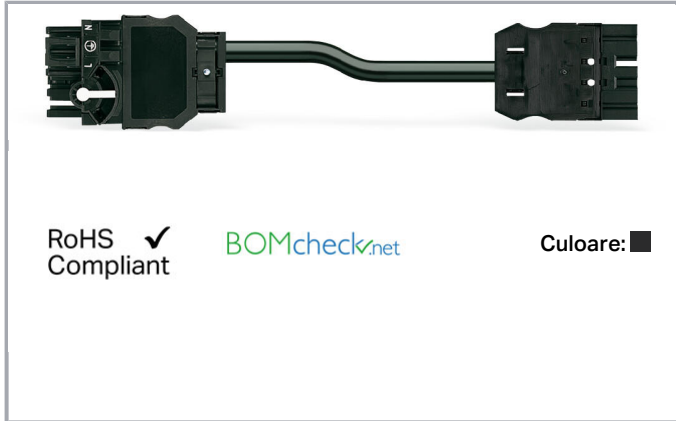

Descriere articol

- Protected against mismatching and maintenance-free
- Additional variable coding is possible

Note:

Cables with a different fire class can be found in the eShop.

Note on mismatching protection:

All WINSTA[®] components are 100% protected against mismatching when:

- plugging different numbers of poles
- plugging while rotated 180
- plugging while laterally staggered
- plugging one pole

Safety information 1:

Application note for the U.S. market (USR): Some versions may also be used for current interruption in accordance with the UL certificate in select applications with currents below 16 A and voltages up to 600 V. For further information, please contact your local sales office.

Date

Electrical data

Note on Contact Resistance

approx. 1 mΩ of contact resistance approx. 0.25 mΩ contact transition plug/socket

Supus modificărilor.

WAGO Kontakttechnik GmbH & Co. KG
/Representative Office Romania
Sos. Pipera-Tunari nr. 1/1
building 1, 2nd floor | 077190 Voluntari, Ilfov
Tel.: +40-(0)31 421 85 68 | Email: info-RO@wago.com

Aveți întrebări despre produsele noastre?
Vă stăm la dispoziție pentru preluarea apelului la +40 (0) 31 421 85 68.



Ratings per IEC/EN 60664-1

| | |
|-----------------------------|---|
| Ratings per | IEC/EN 60664-1 |
| Nominal voltage (III/3) | 400 V |
| Rated surge voltage (III/3) | 6 kV |
| Rated current | 20 A |
| Legend (ratings) | (III / 3) ≙ Overvoltage category III / Pollution degree 3 |

Approvals per UL 1977

| | |
|-----------------------|-------|
| Rated voltage UL 1977 | 600 V |
| Rated current UL 1977 | 23 A |

Connection data

| | |
|---------------------------------|--|
| Pole No. | 5 |
| Total number of potentials | 5 |
| Sheathed cable diameter | 11,2 ... 13,9 mm |
| Wire cross-section | 2,5 mm ² |
| Strip length (outer insulation) | 55 mm |
| Connection type | Distribution connector with phase selection - Plug |

Geometrical Data

| | |
|--------------|--------------------|
| Pin spacing | 10 mm / 0.394 inch |
| Total length | 1 m |

Mechanical data

| | |
|---|---|
| Mating force of a plug-in connection | approx. 20 ... 70 N (depending on pole number) |
| Retention force of a plug-in connection | when locked: > 80N |
| Unmating force of a plug-in connection | when unlocked: approx. 20 ... 70 N (depending on pole number) |
| Number of mating cycles | 200 (without resistive load) 100 (with resistive load $I_N = 25$ A), tested (4 mm ²) |
| Connection type | Distribution connector with phase selection - Plug |
| Type of pre-assembled cable | Interconnecting cable |
| Cable type | H05Z1Z1-F 5G2.5 |
| Marking | L N |
| Protection type | IP20 |
| Note on protection type | Only when mated (these compact connectors are not designed for use in open, easily accessible areas). |

Supus modificărilor.

WAGO Kontakttechnik GmbH & Co. KG
 /Representative Office Romania
 Sos. Pipera-Tunari nr. 1/1
 building 1, 2nd floor | 077190 Voluntari, Ilfov
 Tel.: +40-(0)31 421 85 68 | Email: info-RO@wago.com

Aveți întrebări despre produsele noastre?
 Vă stăm la dispoziție pentru preluarea apelului la +40 (0) 31 421 85 68.



| | |
|-------------------|----------------------------|
| Potential marking | L N |
| Application | General mains applications |

Plug connection

| | |
|-------------------------------|---------------|
| Mismating protection | Yes |
| Locking of plug-in connection | locking lever |
| Locking lever | retrofitable |

Material Data

| | |
|----------------------------------|--|
| Color | black |
| Insulation material | Polyamide 66 (PA 66) |
| Fire class per EN 50575 | E _{ca} |
| Contact material | Copper or copper alloy (surface-treated) |
| Fire load | 4,728 MJ |
| Connector color | black |
| Printing color of mating face | white |
| Strain relief color | black |
| Printing color of strain relief | white |
| Sheathed cable color | black |
| Printing color of sheathed cable | white |
| Halogen-free | Yes |
| Weight | 294,6 g |

Environmental Requirements

| | |
|--|---|
| Processing temperature | -5 ... +40 °C |
| Continuous operating temperature | -35 ... +85 °C |
| Note on continuous operating temperature | PVC cable for temperatures ≤ 70 °C (including halogen-free) Insulating parts for temperatures ≤ 105 °C |

Commercial data

| | |
|-----------------------|---------------|
| Packaging type | not packed |
| Country of origin | DE |
| GTIN | 4045454558604 |
| Customs tariff number | 85444290900 |



Supus modificărilor.

WAGO Kontakttechnik GmbH & Co. KG
/Representative Office Romania
Sos. Pipera-Tunari nr. 1/1
building 1, 2nd floor | 077190 Voluntari, Ilfov
Tel.: +40-(0)31 421 85 68 | Email: info-RO@wago.com

Aveți întrebări despre produsele noastre?
Vă stăm la dispoziție pentru preluarea apelului la +40 (0) 31 421 85 68.

Aprobări / certificate







Country specific Approvals

| Emblemă | Aprobare | Text de aprobare suplimentar | Nume certificat |
|--|---------------------------------------|------------------------------|-----------------|
|  | CCA DEKRA Certification B.V. | EN 61535 | NTR NL-7355 |
|  | KEMA/KEUR DEKRA Certification B.V. | EN 61535 | 2179129.01 |

Counterpart

Produse compatibile

Marking accessories

| | | |
|--|--|--|
| | Nr. articol: 210-334 Marking strips; as a DIN A4 sheet; Strip width 5 mm; Strip length 182 mm; plain; Self-adhesive; white | www.wago.com/210-334 |
|  | Nr. articol: 770-450 Marker card; Plastic; white | www.wago.com/770-450 |
|  | Nr. articol: 770-450/000-001 Marker card; Plastic; white | www.wago.com/770-450/000-001 |
|  | Nr. articol: 770-450/000-002 Marker card; Plastic; white | www.wago.com/770-450/000-002 |
|  | Nr. articol: 770-450/000-005 Marker card; Plastic; white | www.wago.com/770-450/000-005 |
|  | Nr. articol: 770-450/000-006 Marker card; Plastic; white | www.wago.com/770-450/000-006 |
|  | Nr. articol: 770-450/000-012 Marker card; Plastic; white | www.wago.com/770-450/000-012 |

Supus modificărilor.

WAGO Kontakttechnik GmbH & Co. KG
/Representative Office Romania
Sos. Pipera-Tunari nr. 1/1
building 1, 2nd floor | 077190 Voluntari, Ilfov
Tel.: +40-(0)31 421 85 68 | Email: info-RO@wago.com

Aveți întrebări despre produsele noastre?
Vă stăm la dispoziție pentru preluarea apelului la +40 (0) 31 421 85 68.

protection



Nr. articol: 770-201

Lockout cap; 12-pole, separable; 12-pole; for sockets; black

www.wago.com/770-201



Nr. articol: 770-221

Lockout cap; for socket; 12-pole; separable; white

www.wago.com/770-221



Nr. articol: 770-360

Lockout cap; for plugs; 5-pole; separable; yellow

www.wago.com/770-360

Descărcări

CAD/CAE-Data

CAE data

WSCAD Universe 771-8965/017-101

URL

Descărcare

Installation Notes

Familie de produse

<i>WINSTA</i>® MIDI

Afișare globală produse din familie.

Supus modificărilor.