

## Fișă tehnică | Număr articol: 885-108

Stud terminal block; lateral marker slots; for DIN-rail 35 x 15 and 35 x 7.5; 1 stud, M8; 50,00 mm<sup>2</sup>; gray

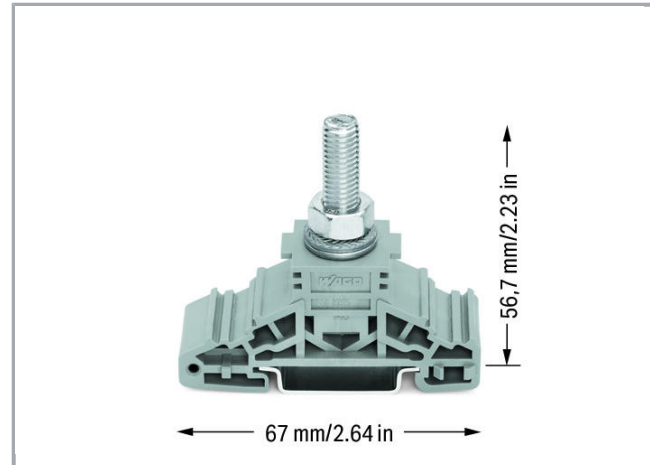

[www.wago.com/885-108](http://www.wago.com/885-108)

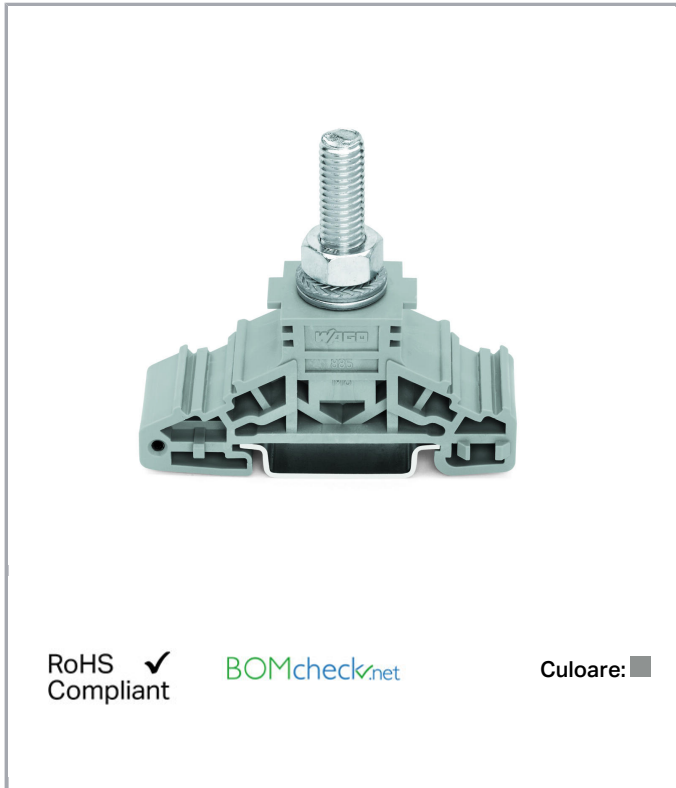

RoHS  Compliant

[BOMcheck.net](https://www.bomcheck.net)

Culoare:

### Date

### Electrical data

#### Ratings per IEC/EN 60664-1

|                             |   |
|-----------------------------|---|
| Nominal voltage (III/3)     | 1000 V  |
| Rated surge voltage (III/3) | 8 kV  |
| Rated current               | 150 A   |
| Legend (ratings)            | (III / 3) ≙ Overvoltage category III / Pollution degree 3 |

#### Approvals per UL 1059

|               |         |
|---------------|---------|
| Approvals per | UL 1059 |
|---------------|---------|

Supus modificărilor.

WAGO Kontakttechnik GmbH & Co. KG  
/Representative Office Romania  
Sos. Pipera-Tunari nr. 1/1  
building 1, 2nd floor | 077190 Voluntari, Ilfov  
Tel.: +40-(0)31 421 85 68 | Email: [info-RO@wago.com](mailto:info-RO@wago.com)

Aveți întrebări despre produsele noastre?  
Vă stăm la dispoziție pentru preluarea apelului la +40 (0) 31 421 85 68.



## Connection data

|                                   |                  |
|-----------------------------------|------------------|
| Connection technology             | Studs connection |
| Actuation type                    | Operating tool   |
| Connectable conductor materials   | Copper           |
| Total number of connection points | 1                |
| Total number of potentials        | 1                |
| Bolzenschraubgewinde              | M8               |

## Geometrical Data

|                                    |                      |
|------------------------------------|----------------------|
| Width                              | 22,8 mm / 0.898 inch |
| Height from upper-edge of DIN-rail | 56,7 mm / 2.232 inch |
| Depth                              | 67 mm / 2.638 inch   |

## Mechanical data

|                   |              |
|-------------------|--------------|
| Tightening torque | 6 ... 12 Nm  |
| Mounting type     | DIN-35 rail  |
| Marking level     | Side marking |

## Material Data

|           |          |
|-----------|----------|
| Color     | gray     |
| Fire load | 0,537 MJ |
| Weight    | 46,8 g   |

## Commercial data

|                       |                                  |
|-----------------------|----------------------------------|
| Product Group         | 1 (Rail Mounted Terminal Blocks) |
| Packaging type        | BOX                              |
| Country of origin     | CN                               |
| GTIN                  | 4050821049234                    |
| Customs tariff number | 85369095990                      |

## Aprobări / certificate

### Country specific Approvals

| Emblemă | Aprobare | Text de aprobare suplimentar | Nume certificat |
|---------|----------|------------------------------|-----------------|
|         | CCA      | EN 60947                     | 2145295.01      |



Supus modificărilor.

WAGO Kontakttechnik GmbH & Co. KG  
 /Representative Office Romania  
 Sos. Pipera-Tunari nr. 1/1  
 building 1, 2nd floor | 077190 Voluntari, Ilfov  
 Tel.: +40-(0)31 421 85 68 | Email: info-RO@wago.com

Aveți întrebări despre produsele noastre?  
 Vă stăm la dispoziție pentru preluarea apelului la +40 (0) 31 421 85 68.

DEKRA Certification B.V.



|  |                          |               |          |
|--|--------------------------|---------------|----------|
|  | CCA                      | EN 60947      | NTR NL   |
|  | DEKRA Certification B.V. |               | 6882     |
|  | CSA                      | C22.2 No. 158 | 70038960 |
|  | DEKRA Certification B.V. |               |          |

## UL-Approvals

| Emblemă  | Aprobare                      | Text de aprobare suplimentar | Nume certificat |
|--|-------------------------------|------------------------------|-----------------|
|  | UL                            | UL 1059                      | E45172-         |
|  | UL International Germany GmbH |                              | 20120322        |



## Counterpart

## Produse compatibile

## General accessories

|  |   |  |
|--|---|--|
|  | <b>Nr. articol: 885-580</b><br>Clip; secures cover against slipping | <a href="http://www.wago.com/885-580">www.wago.com/885-580</a> |
|--|---|--|















## Marking accessories

|  |   |  |
|--|---|--|
|  | <b>Nr. articol: 2009-110</b><br>Marking strips; on reel; not stretchable; plain; snap-on type; white  | <a href="http://www.wago.com/2009-110">www.wago.com/2009-110</a>                 |
|  | <b>Nr. articol: 2009-115</b><br>WMB-Inline; for Smart Printer; 1500 pieces on roll; stretchable 5 - 5.2 mm; plain; snap-on type; white          | <a href="http://www.wago.com/2009-115">www.wago.com/2009-115</a>                 |
|  | <b>Nr. articol: 2009-115/000-002</b><br>WMB-Inline; for Smart Printer; 1500 pieces on roll; stretchable 5 - 5.2 mm; plain; snap-on type; yellow | <a href="http://www.wago.com/2009-115/000-002">www.wago.com/2009-115/000-002</a> |

Supus modificărilor.

WAGO Kontakttechnik GmbH & Co. KG  
 /Representative Office Romania  
 Sos. Pipera-Tunari nr. 1/1  
 building 1, 2nd floor | 077190 Voluntari, Ilfov  
 Tel.: +40-(0)31 421 85 68 | Email: [info-RO@wago.com](mailto:info-RO@wago.com)

Aveți întrebări despre produsele noastre?  
 Vă stăm la dispoziție pentru preluarea apelului la +40 (0) 31 421 85 68.

|  |  |  |
|--|--|--|
|    | <b>Nr. articol:</b> 2009-115/000-006<br>WMB-Inline; for Smart Printer; 1500 pieces on roll; stretchable 5 - 5.2 mm; plain; snap-on type; blue        | <a href="http://www.wago.com/2009-115/000-006">www.wago.com/2009-115/000-006</a> |
|    | <b>Nr. articol:</b> 2009-115/000-007<br>WMB-Inline; for Smart Printer; 1500 pieces on roll; stretchable 5 - 5.2 mm; plain; snap-on type; gray        | <a href="http://www.wago.com/2009-115/000-007">www.wago.com/2009-115/000-007</a> |
|    | <b>Nr. articol:</b> 2009-115/000-012<br>WMB-Inline; for Smart Printer; 1500 pieces on roll; stretchable 5 - 5.2 mm; plain; snap-on type; orange      | <a href="http://www.wago.com/2009-115/000-012">www.wago.com/2009-115/000-012</a> |
|    | <b>Nr. articol:</b> 2009-115/000-017<br>WMB-Inline; for Smart Printer; 1500 pieces on roll; stretchable 5 - 5.2 mm; plain; snap-on type; light green | <a href="http://www.wago.com/2009-115/000-017">www.wago.com/2009-115/000-017</a> |
|    | <b>Nr. articol:</b> 2009-115/000-023<br>WMB-Inline; for Smart Printer; 1500 pieces on roll; stretchable 5 - 5.2 mm; plain; snap-on type; green       | <a href="http://www.wago.com/2009-115/000-023">www.wago.com/2009-115/000-023</a> |
|    | <b>Nr. articol:</b> 2009-115/000-024<br>WMB-Inline; for Smart Printer; 1500 pieces on roll; stretchable 5 - 5.2 mm; plain; snap-on type; violet      | <a href="http://www.wago.com/2009-115/000-024">www.wago.com/2009-115/000-024</a> |
|    | <b>Nr. articol:</b> 2009-135<br>WMB-Inline; for Smart Printer; on reel; stretchable 5 - 5.2 mm; plain; snap-on type; white                           | <a href="http://www.wago.com/2009-135">www.wago.com/2009-135</a>                 |
|   | <b>Nr. articol:</b> 2009-198<br>Adaptor  | <a href="http://www.wago.com/2009-198">www.wago.com/2009-198</a>                 |
| <b>Jumper</b>  |  |  |
|  | <b>Nr. articol:</b> 885-408<br>Assembled jumper bar; 2-way   | <a href="http://www.wago.com/885-408">www.wago.com/885-408</a>                   |
|  | <b>Nr. articol:</b> 885-428<br>Assembled jumper bar; 3-way   | <a href="http://www.wago.com/885-428">www.wago.com/885-428</a>                   |
|  | <b>Nr. articol:</b> 885-448<br>Step-down adjacent jumper bar; 1 level; from M8 to M6   | <a href="http://www.wago.com/885-448">www.wago.com/885-448</a>                   |
| <b>assembling</b>  |  |  |
|  | <b>Nr. articol:</b> 885-566<br>Cover; 1 m long; transparent  | <a href="http://www.wago.com/885-566">www.wago.com/885-566</a>                   |
| <b>End plate</b>   |  |  |
|  | <b>Nr. articol:</b> 885-528<br>Separator plate; 2 mm thick; 110.3 mm wide; gray  | <a href="http://www.wago.com/885-528">www.wago.com/885-528</a>                   |
|  | <b>Nr. articol:</b> 885-548<br>Separator plate with jumper bar recess; 2 mm thick; 110.3 mm wide; gray   | <a href="http://www.wago.com/885-548">www.wago.com/885-548</a>                   |

Supus modificărilor.

WAGO Kontakttechnik GmbH & Co. KG  
/Representative Office Romania  
Sos. Pipera-Tunari nr. 1/1  
building 1, 2nd floor | 077190 Voluntari, Ilfov  
Tel.: +40-(0)31 421 85 68 | Email: info-RO@wago.com

Aveți întrebări despre produsele noastre?  
Vă stăm la dispoziție pentru preluarea apelului la +40 (0) 31 421 85 68.



## Descărcări Documentation

### Additional Information

|                        |             |               |            |
|------------------------|-------------|---------------|------------|
| Technical explanations | Apr 3, 2019 | pdf<br>2,1 MB | Descărcare |
|------------------------|-------------|---------------|------------|

## CAD/CAE-Data

### CAD data

|                      |     |            |
|----------------------|-----|------------|
| 2D/3D Models 885-108 | URL | Descărcare |
|----------------------|-----|------------|

### CAE data

|                           |     |            |
|---------------------------|-----|------------|
| EPLAN Data Portal 885-108 | URL | Descărcare |
|---------------------------|-----|------------|

|                        |     |            |
|------------------------|-----|------------|
| WSCAD Universe 885-108 | URL | Descărcare |
|------------------------|-----|------------|

## Installation Notes

Supus modificărilor.