

## Fișă tehnică | Număr articol: 771-5001/155-000

pre-assembled connecting cable; Eca; Plug/open-ended; 5-pole; Cod. I;  
H05VV-F 3G 1.5 mm<sup>2</sup>; 8 m; 1,50 mm<sup>2</sup>; blue

[www.wago.com/771-5001/155-000](http://www.wago.com/771-5001/155-000)

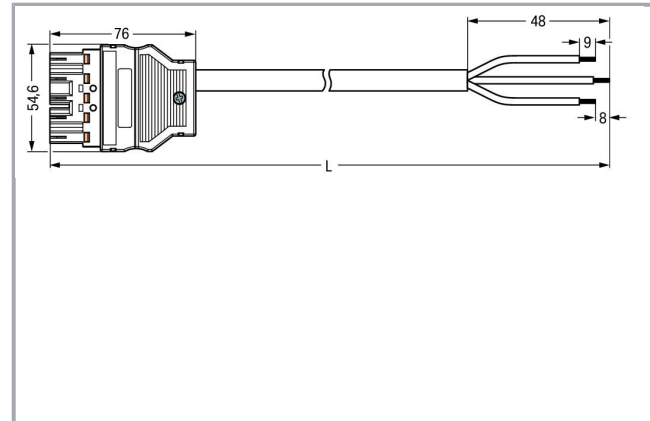
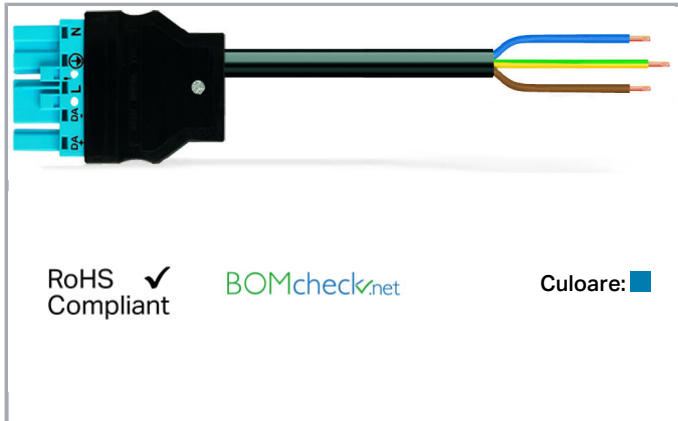

### Descriere articol

- Protected against mismatching and maintenance-free

### Note:

Cables with a different fire class can be found in the eShop.

### Note on mismatching protection:

All WINSTA<sup>®</sup> components are 100% protected against mismatching when:

- plugging different numbers of poles
- plugging while rotated 180
- plugging while laterally staggered
- plugging one pole

### Safety information 1:

Application note for the U.S. market (USR): Some versions may also be used for current interruption in accordance with the UL certificate in select applications with currents below 16 A and voltages up to 600 V. For further information, please contact your local sales office.

### Date

### Electrical data

Note on Contact Resistance

approx. 1 mΩ of contact resistance approx. 0.25 mΩ contact transition plug/socket

Supus modificărilor.

WAGO Kontakttechnik GmbH & Co. KG  
/Representative Office Romania  
Sos. Pipera-Tunari nr. 1/1  
building 1, 2nd floor | 077190 Voluntari, Ilfov  
Tel.: +40-(0)31 421 85 68 | Email: info-RO@wago.com

Aveți întrebări despre produsele noastre?  
Vă stăm la dispoziție pentru preluarea apelului la +40 (0) 31 421 85 68.



### Ratings per IEC/EN 60664-1

Ratings per	IEC/EN 60664-1
Nominal voltage (III/3)	250 V
Rated surge voltage (III/3)	4 kV
Legend (ratings)	(III / 3) $\triangleq$ Overvoltage category III / Pollution degree 3

### Approvals per UL 1977

Rated voltage UL 1977	600 V
Rated current UL 1977	23 A

### Connection data

Strip length	9 mm / 0.35 inch
Pole No.	5
Total number of potentials	3
Ground function	with preceding ground contact
Conductor preparation	tip-bonded
Sheathed cable diameter	7,4 ... 9,4 mm
Wire cross-section	1,5 mm <sup>2</sup>
Strip length (outer insulation)	48 mm
Connection type	Plug - Free end

### Geometrical Data

Pin spacing	10 mm / 0.394 inch
Total length	8 m

### Mechanical data

Technologie	DALI
Coding	I
Mating force of a plug-in connection	approx. 20 ... 70 N (depending on pole number)
Retention force of a plug-in connection	when locked: > 80N
Unmating force of a plug-in connection	when unlocked: approx. 20 ... 70 N (depending on pole number)
Number of mating cycles	200 (without resistive load) 100 (with resistive load $I_N = 25$ A), tested (4 mm <sup>2</sup> )
Connection type	Plug - free end
Type of pre-assembled cable	Connecting cable

Supus modificărilor.

WAGO Kontakttechnik GmbH & Co. KG  
 /Representative Office Romania  
 Sos. Pipera-Tunari nr. 1/1  
 building 1, 2nd floor | 077190 Voluntari, Ilfov  
 Tel.: +40-(0)31 421 85 68 | Email: info-RO@wago.com

Aveți întrebări despre produsele noastre?  
 Vă stăm la dispoziție pentru preluarea apelului la +40 (0) 31 421 85 68.



Cable type	H05VV-F 3G1.5
Protection type	IP20
Note on protection type	Only when mated (these compact connectors are not designed for use in open, easily accessible areas).
Application	Lighting management

### Plug connection

Mismating protection	Yes
Locking of plug-in connection	locking lever
Locking lever	retrofittable

### Material Data

Color	blue
Insulation material	Polyamide 66 (PA 66)
Fire class per EN 50575	E <sub>ca</sub>
Contact material	Copper or copper alloy (surface-treated)
Fire load	239,968 MJ
Connector color	blue
Sheath material	PVC
Weight	814,8 g

### Environmental Requirements

Processing temperature	-5 ... +40 °C
Continuous operating temperature	-35 ... +85 °C
Note on continuous operating temperature	PVC cable for temperatures ≤ 70 °C (including halogen-free) Insulating parts for temperatures ≤ 105 °C

### Commercial data

Packaging type	not packed
Country of origin	DE
GTIN	4055143261524
Customs tariff number	85444290900

### Counterpart







Supus modificărilor.

WAGO Kontakttechnik GmbH & Co. KG  
 /Representative Office Romania  
 Sos. Pipera-Tunari nr. 1/1  
 building 1, 2nd floor | 077190 Voluntari, Ilfov  
 Tel.: +40-(0)31 421 85 68 | Email: info-RO@wago.com

Aveți întrebări despre produsele noastre?  
 Vă stăm la dispoziție pentru preluarea apelului la +40 (0) 31 421 85 68.

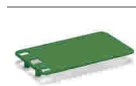
## Produse compatibile

### Marking accessories

	<b>Nr. articol: 210-333</b> Marking strips; as a DIN A4 sheet; Strip width 6 mm; Strip length 182 mm; plain; Self-adhesive; white	<a href="http://www.wago.com/210-333">www.wago.com/210-333</a>
	<b>Nr. articol: 770-450</b> Marker card; Plastic; white	<a href="http://www.wago.com/770-450">www.wago.com/770-450</a>
	<b>Nr. articol: 770-450/000-001</b> Marker card; Plastic; white	<a href="http://www.wago.com/770-450/000-001">www.wago.com/770-450/000-001</a>
	<b>Nr. articol: 770-450/000-002</b> Marker card; Plastic; white	<a href="http://www.wago.com/770-450/000-002">www.wago.com/770-450/000-002</a>
	<b>Nr. articol: 770-450/000-005</b> Marker card; Plastic; white	<a href="http://www.wago.com/770-450/000-005">www.wago.com/770-450/000-005</a>
	<b>Nr. articol: 770-450/000-006</b> Marker card; Plastic; white	<a href="http://www.wago.com/770-450/000-006">www.wago.com/770-450/000-006</a>
	<b>Nr. articol: 770-450/000-012</b> Marker card; Plastic; white	<a href="http://www.wago.com/770-450/000-012">www.wago.com/770-450/000-012</a>

## Installation Notes

### Familie de produse

<i>WINSTA</i>® – Specialty Cable Assemblies

Afișare globală produse din familie.

Supus modificărilor.