

Fișă tehnică | Număr articol: 885-308

Stud terminal block; lateral marker slots; for DIN-rail 35 x 15 and 35 x 7.5; 3 studs, M8; 50,00 mm²; gray

www.wago.com/885-308

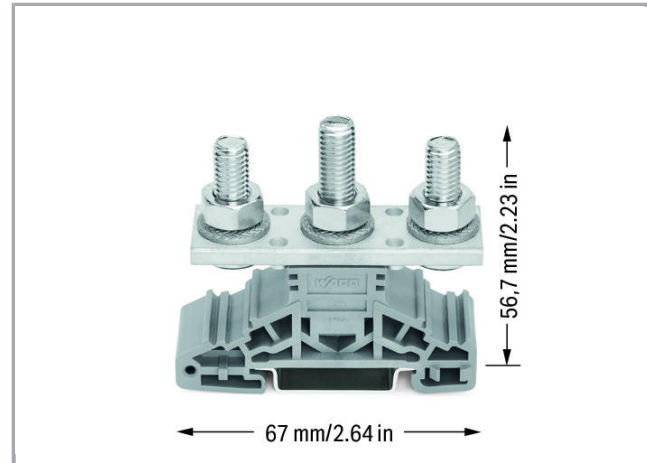

RoHS Compliant

[BOMcheck.net](https://www.bomcheck.net)

Culoare:

Date

Electrical data

Ratings per IEC/EN 60664-1

Nominal voltage (III/3)	1000 V
Rated surge voltage (III/3)	8 kV
Rated current	150 A
Legend (ratings)	(III / 3) ≙ Overvoltage category III / Pollution degree 3

Approvals per UL 1059

Approvals per	UL 1059
---------------	---------

Supus modificărilor.

WAGO Kontakttechnik GmbH & Co. KG
/Representative Office Romania
Sos. Pipera-Tunari nr. 1/1
building 1, 2nd floor | 077190 Voluntari, Ilfov
Tel.: +40-(0)31 421 85 68 | Email: info-RO@wago.com

Aveți întrebări despre produsele noastre?
Vă stăm la dispoziție pentru preluarea apelului la +40 (0) 31 421 85 68.

**Connection data**

Connection technology	Studs connection
Actuation type	Operating tool
Connectable conductor materials	Copper
Total number of connection points	2
Total number of potentials	1
Bolzenschraubgewinde	M8

Geometrical Data

Width	22,8 mm / 0.898 inch
Height from upper-edge of DIN-rail	56,7 mm / 2.232 inch
Depth	67 mm / 2.638 inch

Mechanical data

Tightening torque	6 ... 12 Nm
Mounting type	DIN-35 rail
Marking level	Side marking

Material Data

Color	gray
Fire load	0,537 MJ
Weight	121,8 g

Commercial data

Product Group	1 (Rail Mounted Terminal Blocks)
Packaging type	BOX
Country of origin	CN
GTIN	4050821049265
Customs tariff number	85369095990

Aprobări / certificate**Country specific Approvals**

Emblemă	Aprobare	Text de aprobare suplimentar	Nume certificat
	CCA	EN 60947	NTR NL

Supus modificărilor.

WAGO Kontakttechnik GmbH & Co. KG
 /Representative Office Romania
 Sos. Pipera-Tunari nr. 1/1
 building 1, 2nd floor | 077190 Voluntari, Ilfov
 Tel.: +40-(0)31 421 85 68 | Email: info-RO@wago.com

Aveți întrebări despre produsele noastre?
 Vă stăm la dispoziție pentru preluarea apelului la +40 (0) 31 421 85 68.



DEKRA Certification B.V.

6882



CCA
DEKRA Certification B.V.

EN 60947

2145295.01



CSA
DEKRA Certification B.V.

C22.2 No. 158

70038960

UL-Approvals

Emblemă	Aprobare	Text de aprobare suplimentar	Nume certificat
	UL UL International Germany GmbH	UL 1059	E45172- 20120322

Counterpart

Produce compatibile

End plate



Nr. articol: 885-528
Separator plate; 2 mm thick; 110.3 mm wide; gray

www.wago.com/885-528

Nr. articol: 885-548
Seperator plate with jumper bar recess; 2 mm thick; 110.3 mm wide; gray

www.wago.com/885-548

Marking accessories



Nr. articol: 2009-110
Marking strips; on reel; not stretchable; plain; snap-on type; white

www.wago.com/2009-110















Nr. articol: 2009-115
WMB-Inline; for Smart Printer; 1500 pieces on roll; stretchable 5 - 5.2 mm; plain; snap-on type; white

www.wago.com/2009-115

Supus modificărilor.

WAGO Kontakttechnik GmbH & Co. KG
/Representative Office Romania
Sos. Pipera-Tunari nr. 1/1
building 1, 2nd floor | 077190 Voluntari, Ilfov
Tel.: +40-(0)31 421 85 68 | Email: info-RO@wago.com

Aveți întrebări despre produsele noastre?
Vă stăm la dispoziție pentru preluarea apelului la +40 (0) 31 421 85 68.

	Nr. articol: 2009-115/000-002 WMB-Inline; for Smart Printer; 1500 pieces on roll; stretchable 5 - 5.2 mm; plain; snap-on type; yellow	www.wago.com/2009-115/000-002
	Nr. articol: 2009-115/000-006 WMB-Inline; for Smart Printer; 1500 pieces on roll; stretchable 5 - 5.2 mm; plain; snap-on type; blue	www.wago.com/2009-115/000-006
	Nr. articol: 2009-115/000-007 WMB-Inline; for Smart Printer; 1500 pieces on roll; stretchable 5 - 5.2 mm; plain; snap-on type; gray	www.wago.com/2009-115/000-007
	Nr. articol: 2009-115/000-012 WMB-Inline; for Smart Printer; 1500 pieces on roll; stretchable 5 - 5.2 mm; plain; snap-on type; orange	www.wago.com/2009-115/000-012
	Nr. articol: 2009-115/000-017 WMB-Inline; for Smart Printer; 1500 pieces on roll; stretchable 5 - 5.2 mm; plain; snap-on type; light green	www.wago.com/2009-115/000-017
	Nr. articol: 2009-115/000-023 WMB-Inline; for Smart Printer; 1500 pieces on roll; stretchable 5 - 5.2 mm; plain; snap-on type; green	www.wago.com/2009-115/000-023
	Nr. articol: 2009-115/000-024 WMB-Inline; for Smart Printer; 1500 pieces on roll; stretchable 5 - 5.2 mm; plain; snap-on type; violet	www.wago.com/2009-115/000-024
	Nr. articol: 2009-135 WMB-Inline; for Smart Printer; on reel; stretchable 5 - 5.2 mm; plain; snap-on type; white	www.wago.com/2009-135
	Nr. articol: 2009-198 Adaptor	www.wago.com/2009-198
assembling		
	Nr. articol: 885-566 Cover; 1 m long; transparent	www.wago.com/885-566
General accessories		
	Nr. articol: 885-580 Clip; secures cover against slipping	www.wago.com/885-580
Jumper		
	Nr. articol: 885-408 Assembled jumper bar; 2-way	www.wago.com/885-408
	Nr. articol: 885-428 Assembled jumper bar; 3-way	www.wago.com/885-428
	Nr. articol: 885-448 Step-down adjacent jumper bar; 1 level; from M8 to M6	www.wago.com/885-448

Supus modificărilor.



Descărcări

Documentation

Additional Information

Technical explanations	Apr 3, 2019	pdf 2,1 MB	Descărcare
------------------------	-------------	---------------	------------

CAD/CAE-Data

CAD data

2D/3D Models 885-308	URL	Descărcare
----------------------	-----	------------

CAE data

EPLAN Data Portal 885-308	URL	Descărcare
---------------------------	-----	------------

WSCAD Universe 885-308	URL	Descărcare
------------------------	-----	------------

Installation Notes

Supus modificărilor.

WAGO Kontakttechnik GmbH & Co. KG
/Representative Office Romania
Sos. Pipera-Tunari nr. 1/1
building 1, 2nd floor | 077190 Voluntari, Ilfov
Tel.: +40-(0)31 421 85 68 | Email: info-RO@wago.com

Aveți întrebări despre produsele noastre?
Vă stăm la dispoziție pentru preluarea apelului la +40 (0) 31 421 85 68.