

## Fișă tehnică | Număr articol: 279-907

2-conductor ground terminal block; 1.5 mm<sup>2</sup>; center marking; for DIN-rail 35 x 15 and 35 x 7.5; CAGE CLAMP®; 1,50 mm<sup>2</sup>; green-yellow

[www.wago.com/279-907](http://www.wago.com/279-907)

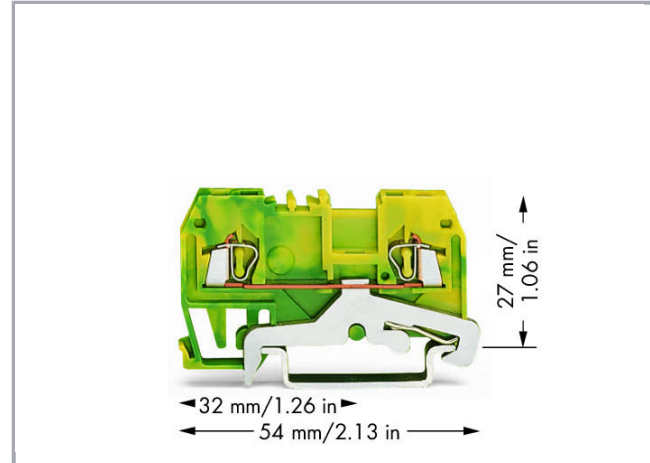

RoHS  Compliant

BOMcheck.net

Culoare:

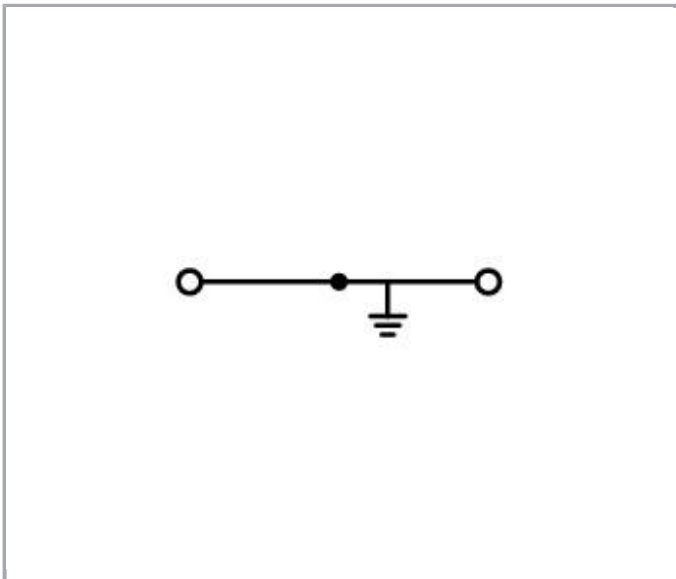

### Date

### Electrical data

Supus modificărilor.

WAGO Kontakttechnik GmbH & Co. KG  
/Representative Office Romania  
Sos. Pipera-Tunari nr. 1/1  
building 1, 2nd floor | 077190 Voluntari, Ilfov  
Tel.: +40-(0)31 421 85 68 | Email: info-RO@wago.com

Aveți întrebări despre produsele noastre?  
Vă stăm la dispoziție pentru preluarea apelului la +40 (0) 31 421 85 68.

**Ratings per IEC/EN 60664-1**

Ratings per	IEC/EN 60947-7-2
-------------	------------------

**Connection data**

Connection technology	CAGE CLAMP®
Actuation type	Operating tool
Connectable conductor materials	Copper
Solid conductor	0,08 ... 1,5 mm <sup>2</sup> / 28 ... 16 AWG
Fine-stranded conductor	0,08 ... 1,5 mm <sup>2</sup> / 28 ... 16 AWG
Strip length	8 ... 9 mm / 0.31 ... 0.35 inch
Total number of connection points	2
Total number of potentials	1
Number of levels	1
Wiring type	Front-entry wiring

**Geometrical Data**

Width	4 mm / 0.157 inch
Height from upper-edge of DIN-rail	27 mm / 1.063 inch
Depth	54 mm / 2.126 inch

**Mechanical data**

Design	horizontal type
Mounting type	DIN-35 rail
Marking level	Center marking

**Material Data**

Color	green-yellow
Insulation material	Polyamide 66 (PA 66)
Fire load	0,076 MJ
Weight	7,9 g

**Commercial data**

Packaging type	BOX
Country of origin	DE

Supus modificărilor.



WAGO Kontakttechnik GmbH & Co. KG  
 /Representative Office Romania  
 Sos. Pipera-Tunari nr. 1/1  
 building 1, 2nd floor | 077190 Voluntari, Ilfov  
 Tel.: +40-(0)31 421 85 68 | Email: info-RO@wago.com

Aveți întrebări despre produsele noastre?  
 Vă stăm la dispoziție pentru preluarea apelului la +40 (0) 31 421 85 68.





GTIN	4045454084479
Customs tariff number	85369010000

## Aprobări / certificate

### Country specific Approvals

Emblemă	Aprobare	Text de aprobare suplimentar	Nume certificat
	CCA DEKRA Certification B.V.	EN 60947	NTR NL-7081
	KEMA/KEUR DEKRA Certification B.V.	EN 60947	2160584.04

### Ship Approvals

Emblemă	Aprobare	Text de aprobare suplimentar	Nume certificat
	ABS American Bureau of Shipping	-	14-HG1293677-PDA
	BV Bureau Veritas S.A.	EN 60947	07436/E0 BV
	DNV GL Det Norske Veritas, Germanischer Lloyd	-	TAE00001V2
	LR Lloyds Register	EN 60947	91/20112 (E9)

### UL-Approvals

Emblemă	Aprobare	Text de aprobare suplimentar	Nume certificat
	UR Underwriters Laboratories Inc.	UL 1059	E45172

Supus modificărilor.

WAGO Kontakttechnik GmbH & Co. KG  
/Representative Office Romania  
Sos. Pipera-Tunari nr. 1/1  
building 1, 2nd floor | 077190 Voluntari, Ilfov  
Tel.: +40-(0)31 421 85 68 | Email: info-RO@wago.com

Aveți întrebări despre produsele noastre?  
Vă stăm la dispoziție pentru preluarea apelului la +40 (0) 31 421 85 68.

## Counterpart

## Produse compatibile















## Marking accessories

	<b>Nr. articol: 2009-114</b> WMB-Inline; for Smart Printer; 2000 pieces on roll; stretchable 4 - 4.2 mm; plain; snap-on type; white	<a href="http://www.wago.com/2009-114">www.wago.com/2009-114</a>
	<b>Nr. articol: 2009-114/000-002</b> WMB-Inline; for Smart Printer; 2000 pieces on roll; stretchable 4 - 4.2 mm; plain; snap-on type; yellow	<a href="http://www.wago.com/2009-114/000-002">www.wago.com/2009-114/000-002</a>
	<b>Nr. articol: 2009-114/000-005</b> WMB-Inline; for Smart Printer; 2000 pieces on roll; stretchable 4 - 4.2 mm; plain; snap-on type; red	<a href="http://www.wago.com/2009-114/000-005">www.wago.com/2009-114/000-005</a>
	<b>Nr. articol: 2009-114/000-006</b> WMB-Inline; for Smart Printer; 2000 pieces on roll; stretchable 4 - 4.2 mm; plain; snap-on type; blue	<a href="http://www.wago.com/2009-114/000-006">www.wago.com/2009-114/000-006</a>
	<b>Nr. articol: 2009-114/000-007</b> WMB-Inline; for Smart Printer; 2000 pieces on roll; stretchable 4 - 4.2 mm; plain; snap-on type; gray	<a href="http://www.wago.com/2009-114/000-007">www.wago.com/2009-114/000-007</a>
	<b>Nr. articol: 2009-114/000-012</b> WMB-Inline; for Smart Printer; 2000 pieces on roll; stretchable 4 - 4.2 mm; plain; snap-on type; orange	<a href="http://www.wago.com/2009-114/000-012">www.wago.com/2009-114/000-012</a>
	<b>Nr. articol: 2009-114/000-023</b> WMB-Inline; for Smart Printer; 2000 pieces on roll; stretchable 4 - 4.2 mm; plain; snap-on type; green	<a href="http://www.wago.com/2009-114/000-023">www.wago.com/2009-114/000-023</a>
	<b>Nr. articol: 2009-114/000-024</b> WMB-Inline; for Smart Printer; 2000 pieces on roll; stretchable 4 - 4.2 mm; plain; snap-on type; violet	<a href="http://www.wago.com/2009-114/000-024">www.wago.com/2009-114/000-024</a>
	<b>Nr. articol: 209-128</b> Adaptor; gray	<a href="http://www.wago.com/209-128">www.wago.com/209-128</a>

Supus modificărilor.



WAGO Kontakttechnik GmbH & Co. KG  
 /Representative Office Romania  
 Sos. Pipera-Tunari nr. 1/1  
 building 1, 2nd floor | 077190 Voluntari, Ilfov  
 Tel.: +40-(0)31 421 85 68 | Email: info-RO@wago.com

Aveți întrebări despre produsele noastre?  
 Vă stăm la dispoziție pentru preluarea apelului la +40 (0) 31 421 85 68.













	<b>Nr. articol: 209-140</b> Group marker carrier; gray	<a href="http://www.wago.com/209-140">www.wago.com/209-140</a>
	<b>Nr. articol: 209-141</b> Group marker carrier; gray	<a href="http://www.wago.com/209-141">www.wago.com/209-141</a>
	<b>Nr. articol: 209-142</b> Group marker carrier; gray	<a href="http://www.wago.com/209-142">www.wago.com/209-142</a>
	<b>Nr. articol: 209-185</b> Adaptor; gray	<a href="http://www.wago.com/209-185">www.wago.com/209-185</a>
	<b>Nr. articol: 249-105</b> Group marker carrier; gray	<a href="http://www.wago.com/249-105">www.wago.com/249-105</a>
	<b>Nr. articol: 793-4501</b> WMB marking card; as card; stretchable 4 - 4.2 mm; plain; snap-on type; white	<a href="http://www.wago.com/793-4501">www.wago.com/793-4501</a>
	<b>Nr. articol: 793-4501/000-002</b> WMB marking card; as card; stretchable 4 - 4.2 mm; plain; snap-on type; yellow	<a href="http://www.wago.com/793-4501/000-002">www.wago.com/793-4501/000-002</a>
	<b>Nr. articol: 793-4501/000-005</b> WMB marking card; as card; stretchable 4 - 4.2 mm; plain; snap-on type; red	<a href="http://www.wago.com/793-4501/000-005">www.wago.com/793-4501/000-005</a>
	<b>Nr. articol: 793-4501/000-006</b> WMB marking card; as card; stretchable 4 - 4.2 mm; plain; snap-on type; blue	<a href="http://www.wago.com/793-4501/000-006">www.wago.com/793-4501/000-006</a>
	<b>Nr. articol: 793-4501/000-007</b> WMB marking card; as card; stretchable 4 - 4.2 mm; plain; snap-on type; gray	<a href="http://www.wago.com/793-4501/000-007">www.wago.com/793-4501/000-007</a>
	<b>Nr. articol: 793-4501/000-012</b> WMB marking card; as card; stretchable 4 - 4.2 mm; plain; snap-on type; orange	<a href="http://www.wago.com/793-4501/000-012">www.wago.com/793-4501/000-012</a>
	<b>Nr. articol: 793-4501/000-014</b> WMB marking card; as card; stretchable 4 - 4.2 mm; plain; snap-on type; brown	<a href="http://www.wago.com/793-4501/000-014">www.wago.com/793-4501/000-014</a>
	<b>Nr. articol: 793-4501/000-017</b> WMB marking card; as card; stretchable 4 - 4.2 mm; plain; snap-on type; green	<a href="http://www.wago.com/793-4501/000-017">www.wago.com/793-4501/000-017</a>
	<b>Nr. articol: 793-4501/000-023</b> WMB marking card; as card; stretchable 4 - 4.2 mm; plain; snap-on type; light green	<a href="http://www.wago.com/793-4501/000-023">www.wago.com/793-4501/000-023</a>
	<b>Nr. articol: 793-4501/000-024</b> WMB marking card; as card; stretchable 4 - 4.2 mm; plain; snap-on type; violet	<a href="http://www.wago.com/793-4501/000-024">www.wago.com/793-4501/000-024</a>

Supus modificărilor.



## tools

	<b>Nr. articol: 210-647</b> Operating tool; Blade: 2.5 x 0.4 mm; with a partially insulated shaft	<a href="http://www.wago.com/210-647">www.wago.com/210-647</a>
	<b>Nr. articol: 210-648</b> Operating tool; Blade: 2.5 x 0.4 mm; with a partially insulated shaft; angled; short	<a href="http://www.wago.com/210-648">www.wago.com/210-648</a>
	<b>Nr. articol: 210-719</b> Operating tool; Blade: 2.5 x 0.4 mm; with a partially insulated shaft	<a href="http://www.wago.com/210-719">www.wago.com/210-719</a>

















## Carrier rail

	<b>Nr. articol: 210-112</b> Steel carrier rail; 35 x 7.5 mm; 1 mm thick; 2 m long; slotted; according to EN 60715; "Hole width 25 mm	<a href="http://www.wago.com/210-112">www.wago.com/210-112</a>
	<b>Nr. articol: 210-113</b> Steel carrier rail; 35 x 7.5 mm; 1 mm thick; 2 m long; unslotted; according to EN 60715	<a href="http://www.wago.com/210-113">www.wago.com/210-113</a>
	<b>Nr. articol: 210-114</b> Steel carrier rail; 35 x 15 mm; 1.5 mm thick; 2 m long; unslotted; similar to EN 60715	<a href="http://www.wago.com/210-114">www.wago.com/210-114</a>
	<b>Nr. articol: 210-115</b> Steel carrier rail; 35 x 7.5 mm; 1 mm thick; 2 m long; slotted; according to EN 60715; "Hole width 18 mm	<a href="http://www.wago.com/210-115">www.wago.com/210-115</a>
	<b>Nr. articol: 210-118</b> Steel carrier rail; 35 x 15 mm; 2.3 mm thick; 2 m long; unslotted; according to EN 60715	<a href="http://www.wago.com/210-118">www.wago.com/210-118</a>
	<b>Nr. articol: 210-196</b> Aluminum carrier rail; 35 x 8.2 mm; 1.6 mm thick; 2 m long; unslotted; similar to EN 60715; silver-colored	<a href="http://www.wago.com/210-196">www.wago.com/210-196</a>
	<b>Nr. articol: 210-197</b> Steel carrier rail; 35 x 15 mm; 1.5 mm thick; 2 m long; slotted; similar to EN 60715	<a href="http://www.wago.com/210-197">www.wago.com/210-197</a>
	<b>Nr. articol: 210-198</b> Copper carrier rail; 35 x 15 mm; 2.3 mm thick; 2 m long; unslotted; according to EN 60715; copper-colored	<a href="http://www.wago.com/210-198">www.wago.com/210-198</a>
	<b>Nr. articol: 210-504</b> Steel carrier rail; 35 x 7.5 mm; 1 mm thick; 2 m long; slotted; galvanized; according to EN 60715	<a href="http://www.wago.com/210-504">www.wago.com/210-504</a>
	<b>Nr. articol: 210-505</b> Steel carrier rail; 35 x 7.5 mm; 1 mm thick; 2 m long; unslotted; galvanized; according to EN 60715	<a href="http://www.wago.com/210-505">www.wago.com/210-505</a>
	<b>Nr. articol: 210-506</b> Steel carrier rail; 35 x 15 mm; 1.5 mm thick; 2 m long; unslotted; galvanized; similar to EN 60715	<a href="http://www.wago.com/210-506">www.wago.com/210-506</a>
	<b>Nr. articol: 210-508</b> Steel carrier rail; 35 x 15 mm; 1.5 mm thick; 2 m long; slotted; galvanized; similar to EN 60715	<a href="http://www.wago.com/210-508">www.wago.com/210-508</a>











## Insulation stop

	<b>Nr. articol: 279-470</b> Insulation stop; 0.08 - 0.2 mm <sup>2</sup> "s" (0.14 mm <sup>2</sup> "f-st"); 5 pieces/strip; white	<a href="http://www.wago.com/279-470">www.wago.com/279-470</a>
	<b>Nr. articol: 279-471</b> Insulation stop; 0.25 mm <sup>2</sup> ; 5 pieces/strip; dark gray	<a href="http://www.wago.com/279-471">www.wago.com/279-471</a>

Supus modificărilor.

Jumper		
	<b>Nr. articol: 249-123</b> Push-in type wire jumper; insulated; wire length 180 mm; Conductor cross section 0.75 mm <sup>2</sup>	<a href="http://www.wago.com/249-123">www.wago.com/249-123</a>
	<b>Nr. articol: 249-125</b> Push-in type wire jumper; insulated; wire length 60 mm; Conductor cross section 0.75 mm <sup>2</sup>	<a href="http://www.wago.com/249-125">www.wago.com/249-125</a>
	<b>Nr. articol: 249-126</b> Push-in type wire jumper; insulated; wire length 110 mm; Conductor cross section 0.75 mm <sup>2</sup>	<a href="http://www.wago.com/249-126">www.wago.com/249-126</a>
	<b>Nr. articol: 249-127</b> Push-in type wire jumper; insulated; wire length 250 mm; Conductor cross section 0.75 mm <sup>2</sup>	<a href="http://www.wago.com/249-127">www.wago.com/249-127</a>
	<b>Nr. articol: 279-402</b> Adjacent jumper; insulated; Nominal current 15 A; gray	<a href="http://www.wago.com/279-402">www.wago.com/279-402</a>
	<b>Nr. articol: 279-409</b> Alternate jumper; insulated; Nominal current 15 A; gray	<a href="http://www.wago.com/279-409">www.wago.com/279-409</a>
	<b>Nr. articol: 279-422</b> Adjacent jumper; insulated; Nominal current 15 A; yellow-green	<a href="http://www.wago.com/279-422">www.wago.com/279-422</a>
	<b>Nr. articol: 279-482</b> Comb-style jumper bar; insulated; 2-way; IN = IN terminal block; gray	<a href="http://www.wago.com/279-482">www.wago.com/279-482</a>
	<b>Nr. articol: 279-483</b> Comb-style jumper bar; insulated; 3-way; IN = IN terminal block; gray	<a href="http://www.wago.com/279-483">www.wago.com/279-483</a>
	<b>Nr. articol: 279-490</b> Comb-style jumper bar; insulated; 10-way; IN = IN terminal block; gray	<a href="http://www.wago.com/279-490">www.wago.com/279-490</a>
	<b>Nr. articol: 279-492</b> Alternate comb-style jumper bar; insulated; 2-way; IN = IN terminal block; gray	<a href="http://www.wago.com/279-492">www.wago.com/279-492</a>
check		
	<b>Nr. articol: 209-170</b> Test plug adapter; 8.3 mm wide; for 4 mm Ø test plugs; suitable for 1.5 mm <sup>2</sup> - 10 mm <sup>2</sup> tbs; gray	<a href="http://www.wago.com/209-170">www.wago.com/209-170</a>
	<b>Nr. articol: 280-404</b> Test plug adapter; 5 mm wide; for test plug 210-137 (2.3 mm Ø); suitable for 1.5 mm <sup>2</sup> - 4 mm <sup>2</sup> tbs; gray	<a href="http://www.wago.com/280-404">www.wago.com/280-404</a>
ferrule		
	<b>Nr. articol: 216-101</b> Ferrule; Sleeve for 0.5 mm <sup>2</sup> / AWG 22; uninsulated; electro-tin plated	<a href="http://www.wago.com/216-101">www.wago.com/216-101</a>
	<b>Nr. articol: 216-102</b> Ferrule; Sleeve for 0.75 mm <sup>2</sup> / AWG 20; uninsulated; electro-tin plated	<a href="http://www.wago.com/216-102">www.wago.com/216-102</a>
	<b>Nr. articol: 216-103</b> Ferrule; Sleeve for 1 mm <sup>2</sup> / AWG 18; uninsulated; electro-tin plated	<a href="http://www.wago.com/216-103">www.wago.com/216-103</a>
	<b>Nr. articol: 216-201</b> Ferrule; Sleeve for 0.5 mm <sup>2</sup> / 20 AWG; insulated; electro-tin plated; white	<a href="http://www.wago.com/216-201">www.wago.com/216-201</a>

Supus modificărilor.

	<b>Nr. articol: 216-202</b> Ferrule; Sleeve for 0.75 mm <sup>2</sup> / 18 AWG; insulated; electro-tin plated; gray	<a href="http://www.wago.com/216-202">www.wago.com/216-202</a>
	<b>Nr. articol: 216-203</b> Ferrule; Sleeve for 1 mm <sup>2</sup> / AWG 18; insulated; electro-tin plated; red	<a href="http://www.wago.com/216-203">www.wago.com/216-203</a>
	<b>Nr. articol: 216-301</b> Ferrule; Sleeve for 0.25 mm <sup>2</sup> / AWG 24; insulated; electro-tin plated; yellow	<a href="http://www.wago.com/216-301">www.wago.com/216-301</a>
	<b>Nr. articol: 216-302</b> Ferrule; Sleeve for 0.34 mm <sup>2</sup> / 22 AWG; insulated; electro-tin plated; green	<a href="http://www.wago.com/216-302">www.wago.com/216-302</a>
<b>Protective Warning Marker</b>		
	<b>Nr. articol: 279-415</b> Protective warning marker; with high-voltage symbol, black; for 5 terminal blocks; yellow	<a href="http://www.wago.com/279-415">www.wago.com/279-415</a>
<b>assembling</b>		
	<b>Nr. articol: 209-106</b> Mounting carrier; for isolated mounting on DIN 35 rails; gray	<a href="http://www.wago.com/209-106">www.wago.com/209-106</a>
	<b>Nr. articol: 709-153</b> Cover; Type 1; suitable for cover carrier, type 1; 1 m long; transparent	<a href="http://www.wago.com/709-153">www.wago.com/709-153</a>
<b>End plate</b>		
	<b>Nr. articol: 279-325</b> End and intermediate plate; 2 mm thick; gray	<a href="http://www.wago.com/279-325">www.wago.com/279-325</a>
	<b>Nr. articol: 279-326</b> Separator plate; 2 mm thick; oversized; gray	<a href="http://www.wago.com/279-326">www.wago.com/279-326</a>
	<b>Nr. articol: 279-328</b> End and intermediate plate; 2 mm thick; orange	<a href="http://www.wago.com/279-328">www.wago.com/279-328</a>
	<b>Nr. articol: 279-329</b> Separator plate; 2 mm thick; oversized; orange	<a href="http://www.wago.com/279-329">www.wago.com/279-329</a>

## Descărcări

### Documentation

#### Additional Information

Technical explanations	Apr 3, 2019	pdf 2,1 MB	Descărcare
------------------------	-------------	---------------	------------

### CAD/CAE-Data

#### CAD data

2D/3D Models 279-907	URL	Descărcare
----------------------	-----	------------

Supus modificărilor.



## CAE data

EPLAN Data Portal 279-907

URL

Descărcare

WSCAD Universe 279-907

URL

Descărcare

## Installation Notes

### Installation

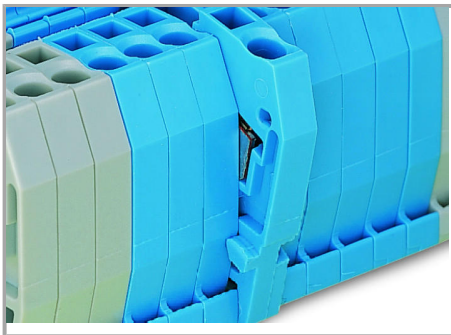

Quick assembly keys prevent reverse mounting.

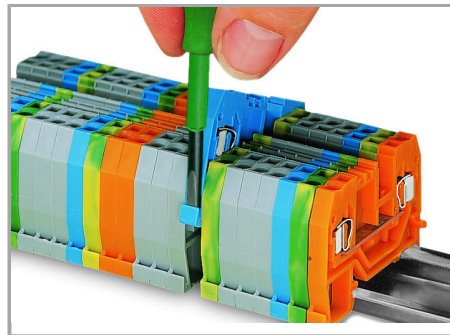

Removing a terminal block from the assembly.

### Inserting a conductor

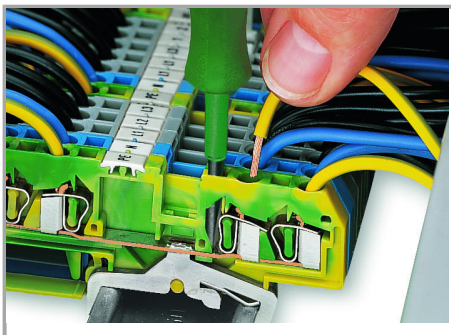

### CAGE CLAMP® connection

Inserting a conductor.

Supus modificărilor.

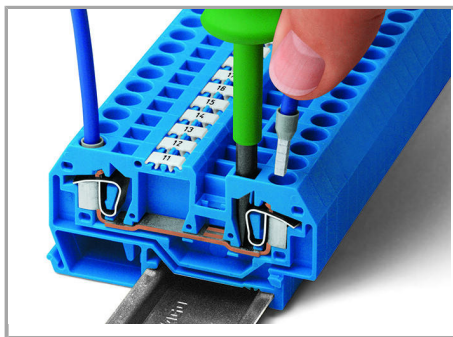

CAGE CLAMP® connection

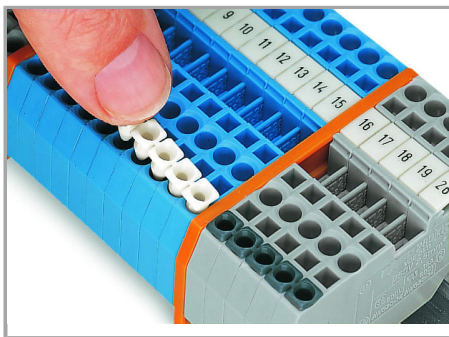

Inserting insulation stops.

Inserting a conductor.

With ferruled conductors, it is necessary to use a terminal block one size larger than the conductor's nominal cross-section.

#### Commoning

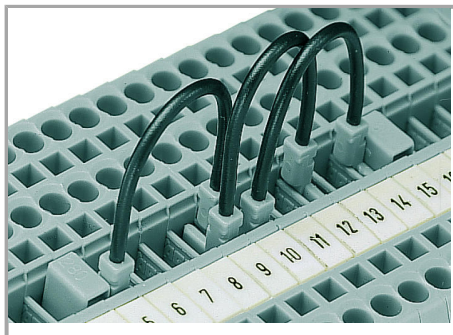

#### Wire jumpers

When installing machines or control systems, it is often necessary to make an additional connection between two terminal blocks that are not next to each other on the rail. In such cases, WAGO's touch-proof, push-in type wire jumpers are the ideal solution.

Supus modificărilor.



These jumpers are compatible with the following rail-mount terminal blocks:

- 279 Series (1.5 mm<sup>2</sup>/16 AWG),
- 
- 280/775/780 Series (2.5 mm<sup>2</sup>/14 AWG)
- 
- 281/769/776/777/781 and 880 Series (4 mm<sup>2</sup>/12 AWG)
- 

They are available in three conductor lengths (60, 110 and 250 mm), allowing up to 60 terminal blocks to be commoned depending on their width (see table on the right).

Compared with the 279 Series, the 280/775/780 and 281/776/777/781 Series can also accommodate two wire jumpers, allowing the use of commoning chains. Furthermore, the 280/769/775/780/880 and 281/776/777/781 Series allow both wire jumper and adjacent jumper to be simultaneously plugged into a same terminal block.

## Testing

Supus modificărilor.

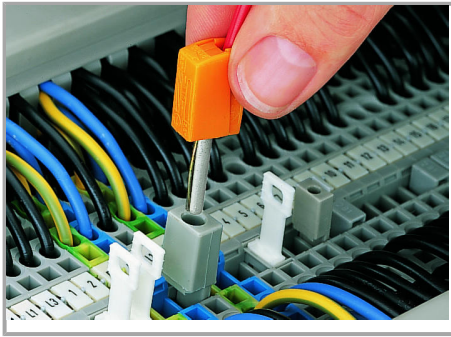

Testing with a test plug

(picture shows 209-170 Test Plug Adapter).

### Marking

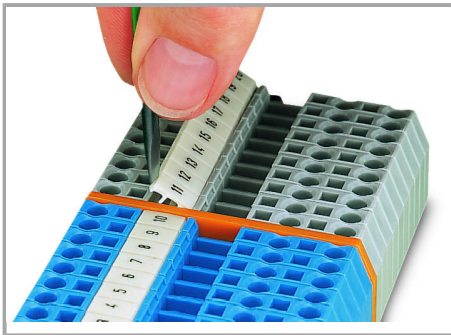

Marking via WMB Multi Marking System.

Supus modificărilor.