

Fișă tehnică | Număr articol: 770-438

Device connector; 3-pole; Cod. A; Plug module with locking lever; white

www.wago.com/770-438

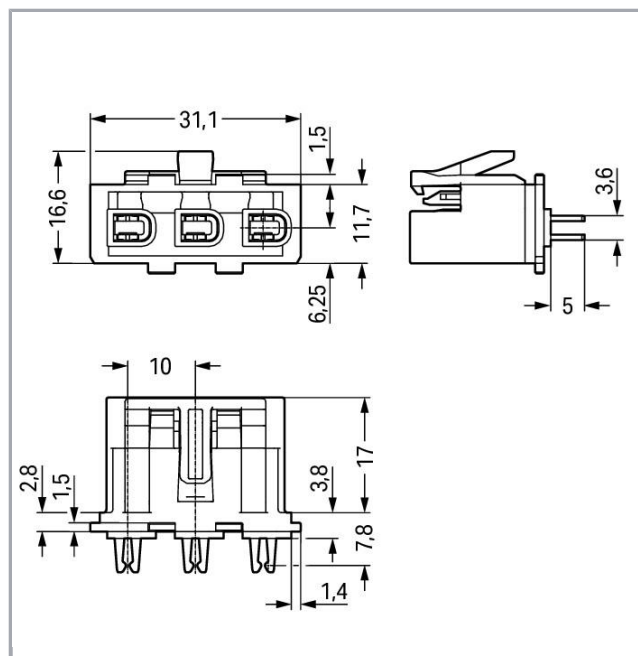
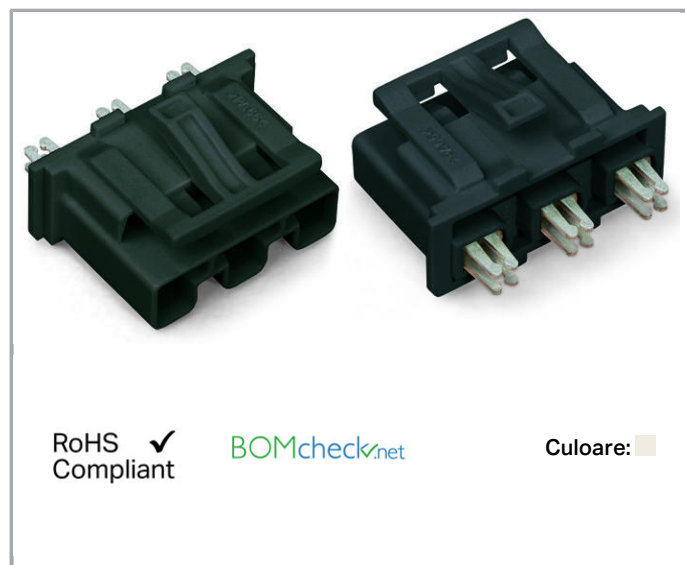

Descriere articol

- Protected against mismatching and maintenance-free
- Push-in CAGE CLAMP® spring pressure connection technology allows solid conductors to be simply pushed into a unit
- Two-wire connection per pole for loops or bridges
- Additional variable coding is possible

Note on mismatching protection:

All WINSTA® components are 100% protected against mismatching when:

- a.) plugging different numbers of poles
- b.) plugging while rotated 180
- c.) plugging while laterally staggered
- d.) plugging one pole

Safety information 1:

Application note for the U.S. market (USR): Some versions may also be used for current interruption in accordance with the UL certificate in select applications with currents below 16 A and voltages up to 600 V. For further information, please contact your local sales office.

Supus modificărilor.

WAGO Kontakttechnik GmbH & Co. KG
/Representative Office Romania
Sos. Pipera-Tunari nr. 1/1
building 1, 2nd floor | 077190 Voluntari, Ilfov
Tel.: +40-(0)31 421 85 68 | Email: info-RO@wago.com

Aveți întrebări despre produsele noastre?
Vă stăm la dispoziție pentru preluarea apelului la +40 (0) 31 421 85 68.



Date

Electrical data

Note on Contact Resistance	approx. 1 mΩ of contact resistance approx. 0.25 mΩ contact transition plug/socket
----------------------------	---

Ratings per IEC/EN 60664-1

Ratings per	IEC/EN 60664-1
Nominal voltage (III/3)	250 V
Rated surge voltage (III/3)	4 kV
Rated current	25 A
Legend (ratings)	(III / 3) ≙ Overvoltage category III / Pollution degree 3

Approvals per UL 1977

Rated voltage UL 1977	600 V
Rated current UL 1977	23 A

Connection data

Note (strip length)	see also packaging or instructions
Pole No.	3
Total number of potentials	3

Geometrical Data

Pin spacing	10 mm / 0.394 inch
Width	31,1 mm / 1.224 inch
Height	24,8 mm / 0.976 inch
Depth	16,55 mm / 0.652 inch

Mechanical data

Coding	A
Mating force of a plug-in connection	approx. 20 ... 70 N (depending on pole number)
Retention force of a plug-in connection	Locked: > 80 N
Unmating force of a plug-in connection	Unlocked: approx. 20 ... 70 N (depending on pole number)
Number of mating cycles	200, without resistive load

Supus modificărilor.

100, with resistive load $I_N = 25$ A, tested (4 mm²/AWG 12)

Protection type	IP20
Application	General mains applications

Plug connection

Contact type (pluggable connector)	Male connector/plug
Connector (connection type)	for current bar
Mismating protection	Yes
Locking of plug-in connection	locking lever
Locking lever	yes

Material Data

Color	white
Insulation material	Polyamide 66 (PA 66)
Clamping spring material	Chrome nickel spring steel (CrNi)
Contact material	Copper or copper alloy (surface-treated)
Fire load	0,099 MJ
Weight	4,8 g

Environmental Requirements

Processing temperature	-5 ... +40 °C
Continuous operating temperature	-35 ... +85 °C
Note on continuous operating temperature	Insulating parts for temperatures ≤ 105 °C

Commercial data

Packaging type	BOX
Country of origin	DE
GTIN	4045454432041
Customs tariff number	85366990990

Aprobări / certificate**Country specific Approvals**

Emblemă	Aprobare	Text de aprobare suplimentar	Nume certificat

Supus modificărilor.

WAGO Kontakttechnik GmbH & Co. KG
 /Representative Office Romania
 Sos. Pipera-Tunari nr. 1/1
 building 1, 2nd floor | 077190 Voluntari, Ilfov
 Tel.: +40-(0)31 421 85 68 | Email: info-RO@wago.com

Aveți întrebări despre produsele noastre?
 Vă stăm la dispoziție pentru preluarea apelului la +40 (0) 31 421 85 68.





CCA
DEKRA Certification B.V.



EN 61535

2173495.02

Ship Approvals

Embleă	Aprobare	Text de aprobare suplimentar	Nume certificat
	ABS American Bureau of Shipping	-	19- HG1868589- PDA
	DNV GL Det Norske Veritas, Germanischer Lloyd	-	TAE00001Z6
	LR Lloyds Register	IEC 61984	02/20050 (E6)

Counterpart

	Nr. articol 770-428 Device connector; 3-pole; Cod. A; white	www.wago.com/770-428
	Nr. articol 771-9993/106-102 pre-assembled connecting cable; Eca; Socket/open-ended; 3-pole; Cod. A; H05VV-F 3G 1.5 mm ² ; 1 m; 1,50 mm ² ; white	www.wago.com/771-9993/106-102
	Nr. articol 771-9993/006-102 pre-assembled interconnecting cable; Eca; Socket/plug; 3-pole; Cod. A; H05VV-F 3G 1.5 mm ² ; 1 m; 1,50 mm ² ; white	www.wago.com/771-9993/006-102

Descărcări

CAD/CAE-Data

CAD data

2D/3D Models 770-438	URL	Descărcare
----------------------	-----	------------

CAE data

EPLAN Data Portal 770-438	URL	Descărcare
---------------------------	-----	------------

WSCAD Universe 770-438	URL	Descărcare
------------------------	-----	------------

Supus modificărilor.

WAGO Kontakttechnik GmbH & Co. KG
/Representative Office Romania
Sos. Pipera-Tunari nr. 1/1
building 1, 2nd floor | 077190 Voluntari, Ilfov
Tel.: +40-(0)31 421 85 68 | Email: info-RO@wago.com

Aveți întrebări despre produsele noastre?
Vă stăm la dispoziție pentru preluarea apelului la +40 (0) 31 421 85 68.

Installation Notes

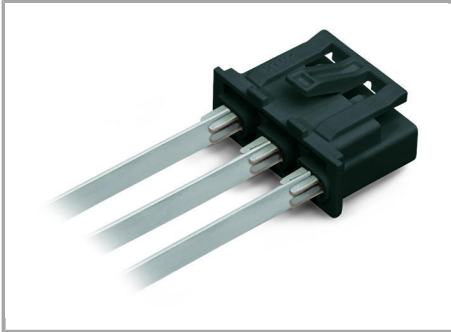

Device connectors can be cost-effectively installed in appropriate guide slots of a housing. Internal electrical connection is performed by contacting the 0.8 mm thick current bars.

Familie de produse

WINSTA® MIDI

Afișare globală produse din familie.

Supus modificărilor.