

## Fișă tehnică | Număr articol: 279-101

2-conductor through terminal block; 1.5 mm<sup>2</sup>; lateral marker slots; for DIN-rail 35 x 15 and 35 x 7.5; CAGE CLAMP®; 1,50 mm<sup>2</sup>; gray

[www.wago.com/279-101](http://www.wago.com/279-101)

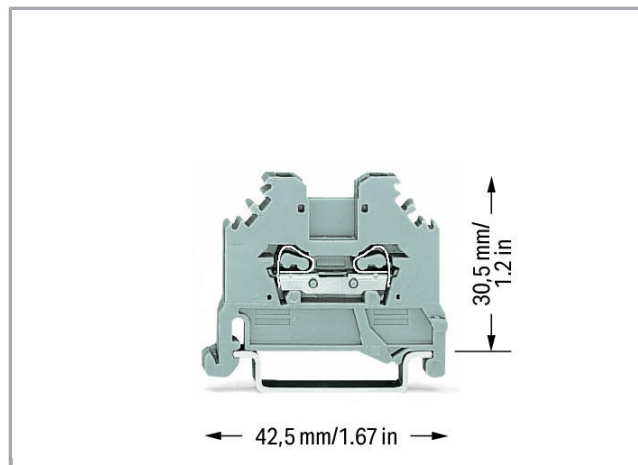

Supus modificărilor.

WAGO Kontakttechnik GmbH & Co. KG  
/Representative Office Romania  
Sos. Pipera-Tunari nr. 1/1  
building 1, 2nd floor | 077190 Voluntari, Ilfov  
Tel.: +40-(0)31 421 85 68 | Email: info-RO@wago.com

Aveți întrebări despre produsele noastre?  
Vă stăm la dispoziție pentru preluarea apelului la +40 (0) 31 421 85 68.

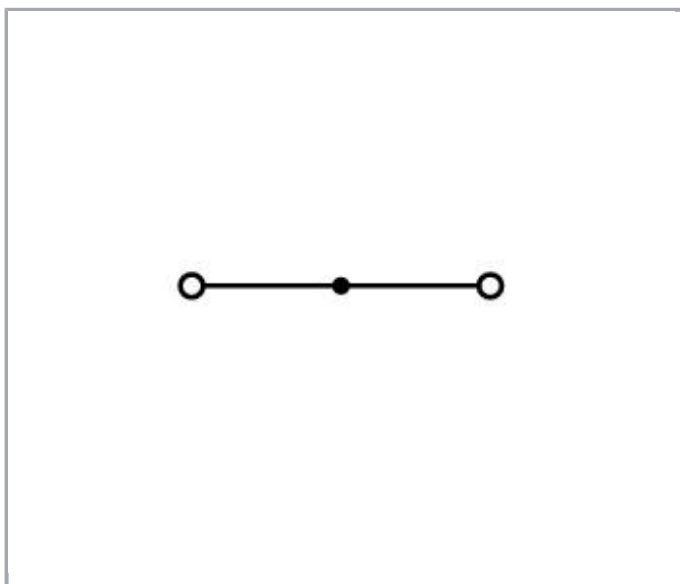
**Date****Electrical data****Ratings per IEC/EN 60664-1**

|                             |   |
|-----------------------------|---|
| Ratings per                 | IEC/EN 60947-7-1  |
| Nominal voltage (III/3)     | 800 V   |
| Rated surge voltage (III/3) | 8 kV  |
| Rated current               | 18 A  |
| Legend (ratings)            | (III / 3) ≙ Overvoltage category III / Pollution degree 3 |

**Connection data**

|                                   |  |
|-----------------------------------|--|
| Connection technology             | CAGE CLAMP®                                  |
| Actuation type                    | Operating tool                               |
| Connectable conductor materials   | Copper                                       |
| Solid conductor                   | 0,08 ... 1,5 mm <sup>2</sup> / 28 ... 16 AWG |
| Fine-stranded conductor           | 0,08 ... 1,5 mm <sup>2</sup> / 28 ... 16 AWG |
| Strip length                      | 8 ... 9 mm / 0.31 ... 0.35 inch              |
| Total number of connection points | 2  |
| Total number of potentials        | 1  |
| Number of levels                  | 1  |
| Wiring type                       | Side-entry wiring                            |

Supus modificărilor.

WAGO Kontakttechnik GmbH & Co. KG  
 /Representative Office Romania  
 Sos. Pipera-Tunari nr. 1/1  
 building 1, 2nd floor | 077190 Voluntari, Ilfov  
 Tel.: +40-(0)31 421 85 68 | Email: info-RO@wago.com

Aveți întrebări despre produsele noastre?  
 Vă stăm la dispoziție pentru preluarea apelului la +40 (0) 31 421 85 68.

## Geometrical Data

|                                    |                      |
|------------------------------------|----------------------|
| Width                              | 4 mm / 0.157 inch    |
| Height from upper-edge of DIN-rail | 30,5 mm / 1.201 inch |
| Depth                              | 42,5 mm / 1.673 inch |

## Mechanical data

|               |                 |
|---------------|-----------------|
| Design        | horizontal type |
| Mounting type | DIN-35 rail     |
| Marking level | Side marking    |

## Material Data



|                     |                      |
|---------------------|----------------------|
| Color               | gray                 |
| Insulation material | Polyamide 66 (PA 66) |
| Fire load           | 0,069 MJ             |
| Weight              | 3,2 g                |

## Commercial data

|                |                                  |
|----------------|----------------------------------|
| Product Group  | 1 (Rail Mounted Terminal Blocks) |
| Packaging type | BOX                              |
| GTIN           | 4050821413066                    |





## Aprobări / certificate

### Country specific Approvals

| Emblemă  | Aprobare                              | Text de aprobare suplimentar | Nume certificat |
|--|---------------------------------------|------------------------------|-----------------|
|  | CCA<br>DEKRA Certification B.V.       | EN 60947                     | NTR NL-7081     |
|  | CSA<br>DEKRA Certification B.V.       | C22.2 No. 158                | 70133738        |
|  | KEMA/KEUR<br>DEKRA Certification B.V. | EN 60947                     | 2160584.04      |

Supus modificărilor.

## Ship Approvals

| Emblemă   | Aprobare  | Text de aprobare suplimentar | Nume certificat          |
|---|---|------------------------------|--------------------------|
|   | <b>ABS</b><br>American Bureau of Shipping               | -                            | 20-<br>HG1941090-<br>PDA |
|  | <b>BV</b><br>Bureau Veritas S.A.                        | EN 60947                     | 07436/E0 BV              |
|   | <b>DNV GL</b><br>Det Norske Veritas, Germanischer Lloyd | -                            | TAE00001V2               |
|  | <b>LR</b><br>Lloyds Register                            | EN 60947                     | 91/20112<br>(E9)         |

## UL-Approvals

| Emblemă  | Aprobare                                    | Text de aprobare suplimentar | Nume certificat |
|--|---|------------------------------|-----------------|
|  | <b>UR</b><br>Underwriters Laboratories Inc. | UL 1059                      | E45172          |

## Counterpart

## Produse compatibile

## assembling

Supus modificărilor.

WAGO Kontakttechnik GmbH & Co. KG  
/Representative Office Romania  
Sos. Pipera-Tunari nr. 1/1  
building 1, 2nd floor | 077190 Voluntari, Ilfov  
Tel.: +40-(0)31 421 85 68 | Email: info-RO@wago.com

Aveți întrebări despre produsele noastre?  
Vă stăm la dispoziție pentru preluarea apelului la +40 (0) 31 421 85 68.



**Nr. articol: 209-106**  
Mounting carrier; for isolated mounting on DIN 35 rails; gray

[www.wago.com/209-106](http://www.wago.com/209-106)



**Nr. articol: 709-153**  
Cover; Type 1; suitable for cover carrier, type 1; 1 m long; transparent

[www.wago.com/709-153](http://www.wago.com/709-153)

#### Jumper

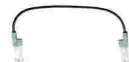

**Nr. articol: 249-123**  
Push-in type wire jumper; insulated; wire length 180 mm; Conductor cross section 0.75 mm<sup>2</sup>

[www.wago.com/249-123](http://www.wago.com/249-123)



**Nr. articol: 249-125**  
Push-in type wire jumper; insulated; wire length 60 mm; Conductor cross section 0.75 mm<sup>2</sup>

[www.wago.com/249-125](http://www.wago.com/249-125)



**Nr. articol: 249-126**  
Push-in type wire jumper; insulated; wire length 110 mm; Conductor cross section 0.75 mm<sup>2</sup>

[www.wago.com/249-126](http://www.wago.com/249-126)

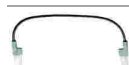

**Nr. articol: 249-127**  
Push-in type wire jumper; insulated; wire length 250 mm; Conductor cross section 0.75 mm<sup>2</sup>

[www.wago.com/249-127](http://www.wago.com/249-127)



**Nr. articol: 279-402**  
Adjacent jumper; insulated; Nominal current 15 A; gray

[www.wago.com/279-402](http://www.wago.com/279-402)



**Nr. articol: 279-409**  
Alternate jumper; insulated; Nominal current 15 A; gray

[www.wago.com/279-409](http://www.wago.com/279-409)



**Nr. articol: 279-422**  
Adjacent jumper; insulated; Nominal current 15 A; yellow-green

[www.wago.com/279-422](http://www.wago.com/279-422)



**Nr. articol: 284-414**  
Step-down jumper; insulated; from 10/6 mm<sup>2</sup> to 4/2.5/1.5 mm<sup>2</sup>; Nominal current 15 A; gray

[www.wago.com/284-414](http://www.wago.com/284-414)

#### check



**Nr. articol: 209-170**  
Test plug adapter; 8.3 mm wide; for 4 mm Ø test plugs; suitable for 1.5 mm<sup>2</sup> - 10 mm<sup>2</sup> tbs; gray

[www.wago.com/209-170](http://www.wago.com/209-170)



**Nr. articol: 280-404**  
Test plug adapter; 5 mm wide; for test plug 210-137 (2.3 mm Ø); suitable for 1.5 mm<sup>2</sup> - 4 mm<sup>2</sup> tbs; gray

[www.wago.com/280-404](http://www.wago.com/280-404)

#### ferrule



**Nr. articol: 216-101**  
Ferrule; Sleeve for 0.5 mm<sup>2</sup> / AWG 22; uninsulated; electro-tin plated

[www.wago.com/216-101](http://www.wago.com/216-101)



**Nr. articol: 216-102**  
Ferrule; Sleeve for 0.75 mm<sup>2</sup> / AWG 20; uninsulated; electro-tin plated

[www.wago.com/216-102](http://www.wago.com/216-102)



**Nr. articol: 216-103**  
Ferrule; Sleeve for 1 mm<sup>2</sup> / AWG 18; uninsulated; electro-tin plated

[www.wago.com/216-103](http://www.wago.com/216-103)



**Nr. articol: 216-201**  
Ferrule; Sleeve for 0.5 mm<sup>2</sup> / 20 AWG; insulated; electro-tin plated; white















[www.wago.com/216-201](http://www.wago.com/216-201)

















**Nr. articol: 216-202**  
Ferrule; Sleeve for 0.75 mm<sup>2</sup> / 18 AWG; insulated; electro-tin plated; gray

[www.wago.com/216-202](http://www.wago.com/216-202)

Supus modificărilor.

|  |   |  |
|--|---|--|
|     | <b>Nr. articol: 216-203</b><br>Ferrule; Sleeve for 1 mm <sup>2</sup> / AWG 18; insulated; electro-tin plated; red                         | <a href="http://www.wago.com/216-203">www.wago.com/216-203</a>   |
|  | <b>Nr. articol: 216-301</b><br>Ferrule; Sleeve for 0.25 mm <sup>2</sup> / AWG 24; insulated; electro-tin plated; yellow                   | <a href="http://www.wago.com/216-301">www.wago.com/216-301</a>   |
|     | <b>Nr. articol: 216-302</b><br>Ferrule; Sleeve for 0.34 mm <sup>2</sup> / 22 AWG; insulated; electro-tin plated; green                    | <a href="http://www.wago.com/216-302">www.wago.com/216-302</a>   |
| <b>Carrier rail</b>  |   |  |
|    | <b>Nr. articol: 210-112</b><br>Steel carrier rail; 35 x 7.5 mm; 1 mm thick; 2 m long; slotted; according to EN 60715; "Hole width 25 mm   | <a href="http://www.wago.com/210-112">www.wago.com/210-112</a>   |
|    | <b>Nr. articol: 210-113</b><br>Steel carrier rail; 35 x 7.5 mm; 1 mm thick; 2 m long; unslotted; according to EN 60715                    | <a href="http://www.wago.com/210-113">www.wago.com/210-113</a>   |
|    | <b>Nr. articol: 210-114</b><br>Steel carrier rail; 35 x 15 mm; 1.5 mm thick; 2 m long; unslotted; similar to EN 60715                     | <a href="http://www.wago.com/210-114">www.wago.com/210-114</a>   |
|    | <b>Nr. articol: 210-115</b><br>Steel carrier rail; 35 x 7.5 mm; 1 mm thick; 2 m long; slotted; according to EN 60715; "Hole width 18 mm   | <a href="http://www.wago.com/210-115">www.wago.com/210-115</a>   |
|    | <b>Nr. articol: 210-118</b><br>Steel carrier rail; 35 x 15 mm; 2.3 mm thick; 2 m long; unslotted; according to EN 60715                   | <a href="http://www.wago.com/210-118">www.wago.com/210-118</a>   |
|   | <b>Nr. articol: 210-196</b><br>Aluminum carrier rail; 35 x 8.2 mm; 1.6 mm thick; 2 m long; unslotted; similar to EN 60715; silver-colored | <a href="http://www.wago.com/210-196">www.wago.com/210-196</a>   |
|  | <b>Nr. articol: 210-197</b><br>Steel carrier rail; 35 x 15 mm; 1.5 mm thick; 2 m long; slotted; similar to EN 60715                       | <a href="http://www.wago.com/210-197">www.wago.com/210-197</a>   |
|  | <b>Nr. articol: 210-198</b><br>Copper carrier rail; 35 x 15 mm; 2.3 mm thick; 2 m long; unslotted; according to EN 60715; copper-colored  | <a href="http://www.wago.com/210-198">www.wago.com/210-198</a>   |
|  | <b>Nr. articol: 210-504</b><br>Steel carrier rail; 35 x 7.5 mm; 1 mm thick; 2 m long; slotted; galvanized; according to EN 60715          | <a href="http://www.wago.com/210-504">www.wago.com/210-504</a>   |
|  | <b>Nr. articol: 210-505</b><br>Steel carrier rail; 35 x 7.5 mm; 1 mm thick; 2 m long; unslotted; galvanized; according to EN 60715        | <a href="http://www.wago.com/210-505">www.wago.com/210-505</a>   |
|  | <b>Nr. articol: 210-506</b><br>Steel carrier rail; 35 x 15 mm; 1.5 mm thick; 2 m long; unslotted; galvanized; similar to EN 60715         | <a href="http://www.wago.com/210-506">www.wago.com/210-506</a>   |
|  | <b>Nr. articol: 210-508</b><br>Steel carrier rail; 35 x 15 mm; 1.5 mm thick; 2 m long; slotted; galvanized; similar to EN 60715           | <a href="http://www.wago.com/210-508">www.wago.com/210-508</a>   |
| <b>Marking accessories</b>   |   |  |
|  | <b>Nr. articol: 2009-114</b><br>WMB-Inline; for Smart Printer; 2000 pieces on roll; stretchable 4 - 4.2 mm; plain; snap-on type; white    | <a href="http://www.wago.com/2009-114">www.wago.com/2009-114</a> |

Supus modificărilor.

|  |   |  |
|--|---|--|
|    | <b>Nr. articol: 2009-114/000-002</b><br>WMB-Inline; for Smart Printer; 2000 pieces on roll; stretchable 4 - 4.2 mm; plain; snap-on type; yellow | <a href="http://www.wago.com/2009-114/000-002">www.wago.com/2009-114/000-002</a> |
|    | <b>Nr. articol: 2009-114/000-005</b><br>WMB-Inline; for Smart Printer; 2000 pieces on roll; stretchable 4 - 4.2 mm; plain; snap-on type; red    | <a href="http://www.wago.com/2009-114/000-005">www.wago.com/2009-114/000-005</a> |
|    | <b>Nr. articol: 2009-114/000-006</b><br>WMB-Inline; for Smart Printer; 2000 pieces on roll; stretchable 4 - 4.2 mm; plain; snap-on type; blue   | <a href="http://www.wago.com/2009-114/000-006">www.wago.com/2009-114/000-006</a> |
|    | <b>Nr. articol: 2009-114/000-007</b><br>WMB-Inline; for Smart Printer; 2000 pieces on roll; stretchable 4 - 4.2 mm; plain; snap-on type; gray   | <a href="http://www.wago.com/2009-114/000-007">www.wago.com/2009-114/000-007</a> |
|    | <b>Nr. articol: 2009-114/000-012</b><br>WMB-Inline; for Smart Printer; 2000 pieces on roll; stretchable 4 - 4.2 mm; plain; snap-on type; orange | <a href="http://www.wago.com/2009-114/000-012">www.wago.com/2009-114/000-012</a> |
|    | <b>Nr. articol: 2009-114/000-023</b><br>WMB-Inline; for Smart Printer; 2000 pieces on roll; stretchable 4 - 4.2 mm; plain; snap-on type; green  | <a href="http://www.wago.com/2009-114/000-023">www.wago.com/2009-114/000-023</a> |
|    | <b>Nr. articol: 2009-114/000-024</b><br>WMB-Inline; for Smart Printer; 2000 pieces on roll; stretchable 4 - 4.2 mm; plain; snap-on type; violet | <a href="http://www.wago.com/2009-114/000-024">www.wago.com/2009-114/000-024</a> |
|  | <b>Nr. articol: 209-140</b><br>Group marker carrier; gray   | <a href="http://www.wago.com/209-140">www.wago.com/209-140</a>                   |
|  | <b>Nr. articol: 209-141</b><br>Group marker carrier; gray   | <a href="http://www.wago.com/209-141">www.wago.com/209-141</a>                   |
|  | <b>Nr. articol: 209-142</b><br>Group marker carrier; gray   | <a href="http://www.wago.com/209-142">www.wago.com/209-142</a>                   |
|  | <b>Nr. articol: 249-105</b><br>Group marker carrier; gray   | <a href="http://www.wago.com/249-105">www.wago.com/249-105</a>                   |
|  | <b>Nr. articol: 793-4501</b><br>WMB marking card; as card; stretchable 4 - 4.2 mm; plain; snap-on type; white                                   | <a href="http://www.wago.com/793-4501">www.wago.com/793-4501</a>                 |
|  | <b>Nr. articol: 793-4501/000-002</b><br>WMB marking card; as card; stretchable 4 - 4.2 mm; plain; snap-on type; yellow                          | <a href="http://www.wago.com/793-4501/000-002">www.wago.com/793-4501/000-002</a> |
|  | <b>Nr. articol: 793-4501/000-005</b><br>WMB marking card; as card; stretchable 4 - 4.2 mm; plain; snap-on type; red                             | <a href="http://www.wago.com/793-4501/000-005">www.wago.com/793-4501/000-005</a> |
|  | <b>Nr. articol: 793-4501/000-006</b><br>WMB marking card; as card; stretchable 4 - 4.2 mm; plain; snap-on type; blue                            | <a href="http://www.wago.com/793-4501/000-006">www.wago.com/793-4501/000-006</a> |

Supus modificărilor.



Nr. articol: 793-4501/000-007

WMB marking card; as card; stretchable 4 - 4.2 mm; plain; snap-on type; gray

[www.wago.com/793-4501/000-007](http://www.wago.com/793-4501/000-007)

Nr. articol: 793-4501/000-012

WMB marking card; as card; stretchable 4 - 4.2 mm; plain; snap-on type; orange

[www.wago.com/793-4501/000-012](http://www.wago.com/793-4501/000-012)

Nr. articol: 793-4501/000-017

WMB marking card; as card; stretchable 4 - 4.2 mm; plain; snap-on type; green

[www.wago.com/793-4501/000-017](http://www.wago.com/793-4501/000-017)

Nr. articol: 793-4501/000-023

WMB marking card; as card; stretchable 4 - 4.2 mm; plain; snap-on type; light green

[www.wago.com/793-4501/000-023](http://www.wago.com/793-4501/000-023)

Nr. articol: 793-4501/000-024

WMB marking card; as card; stretchable 4 - 4.2 mm; plain; snap-on type; violet

[www.wago.com/793-4501/000-024](http://www.wago.com/793-4501/000-024)

#### End plate



Nr. articol: 280-301

End and intermediate plate; 2.5 mm thick; gray

[www.wago.com/280-301](http://www.wago.com/280-301)

Nr. articol: 280-302

End and intermediate plate; 2.5 mm thick; orange

[www.wago.com/280-302](http://www.wago.com/280-302)

Nr. articol: 280-322

Separator plate; 2 mm thick; oversized; orange

[www.wago.com/280-322](http://www.wago.com/280-322)

Nr. articol: 280-332

Separator plate; 2 mm thick; oversized; gray

[www.wago.com/280-332](http://www.wago.com/280-332)

Nr. articol: 281-333

Step-down intermediate plate; 1 mm thick; "only for 4 mm terminal blocks; gray

[www.wago.com/281-333](http://www.wago.com/281-333)

Nr. articol: 281-336

Step-down intermediate plate; 1 mm thick; "only for 4 mm terminal blocks; orange

[www.wago.com/281-336](http://www.wago.com/281-336)

#### tools



Nr. articol: 210-647

Operating tool; Blade: 2.5 x 0.4 mm; with a partially insulated shaft

[www.wago.com/210-647](http://www.wago.com/210-647)

Nr. articol: 210-648

Operating tool; Blade: 2.5 x 0.4 mm; with a partially insulated shaft; angled; short

[www.wago.com/210-648](http://www.wago.com/210-648)

Nr. articol: 210-719

Operating tool; Blade: 2.5 x 0.4 mm; with a partially insulated shaft

[www.wago.com/210-719](http://www.wago.com/210-719)

#### Protective Warning Marker

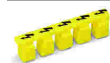

Nr. articol: 279-405

Protective warning marker; with high-voltage symbol, black; for 5 terminal blocks; yellow

[www.wago.com/279-405](http://www.wago.com/279-405)

Supus modificărilor.



## Descărcări Documentation

### Additional Information

|                        |             |               |            |
|------------------------|-------------|---------------|------------|
| Technical explanations | Apr 3, 2019 | pdf<br>2,1 MB | Descărcare |
|------------------------|-------------|---------------|------------|

## CAD/CAE-Data

### CAD data

|                      |     |            |
|----------------------|-----|------------|
| 2D/3D Models 279-101 | URL | Descărcare |
|----------------------|-----|------------|

### CAE data

|                           |     |            |
|---------------------------|-----|------------|
| EPLAN Data Portal 279-101 | URL | Descărcare |
|---------------------------|-----|------------|

|                        |     |            |
|------------------------|-----|------------|
| WSCAD Universe 279-101 | URL | Descărcare |
|------------------------|-----|------------|

## Installation Notes

### Installation

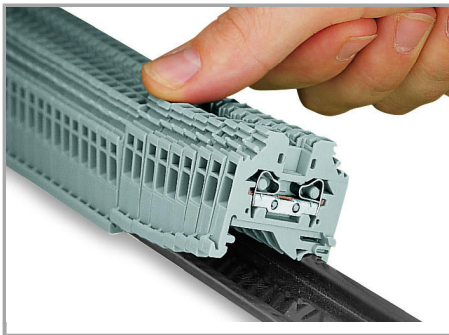

Snapping side-entry rail-mount terminal blocks onto the carrier rail.

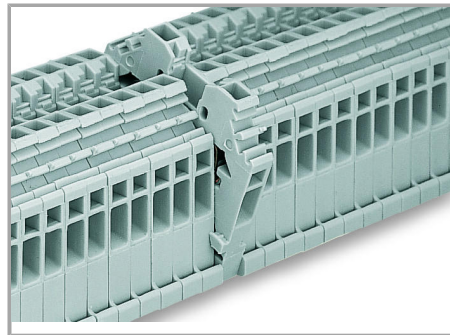

Quick assembly keys prevent reverse mounting.

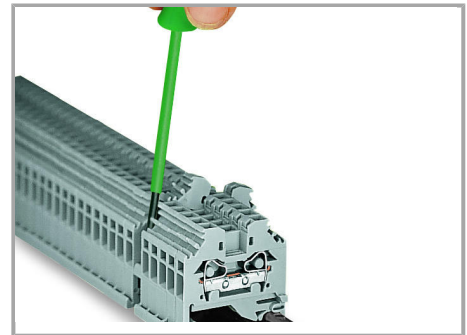

Removing a terminal block from the assembly.

Supus modificărilor.

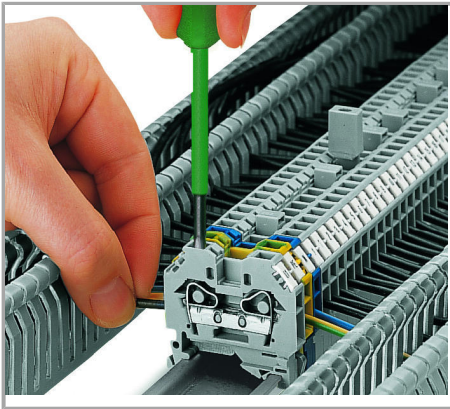

#### CAGE CLAMP® connection

Inserting a conductor.

With ferruled conductors, it is necessary to use a terminal block one size larger than the conductor's nominal cross-section.

#### Commoning

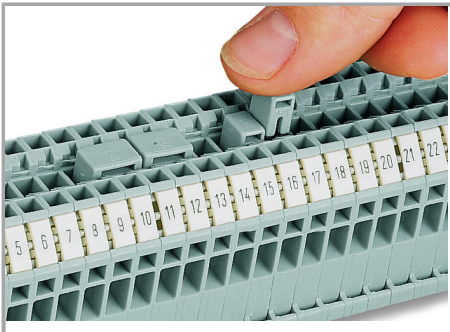

Commoning using an adjacent jumper (280-402).

Push jumper down until fully inserted.

#### Testing

Supus modificărilor.

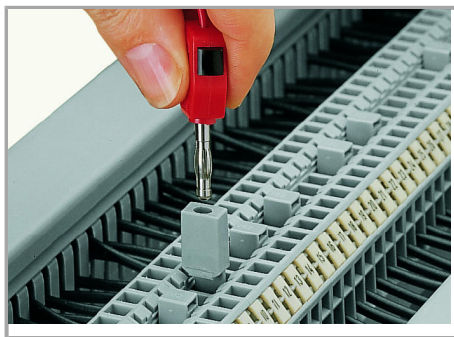

Testing with a test plug

(picture shows 209-170 Test Plug Adapter).

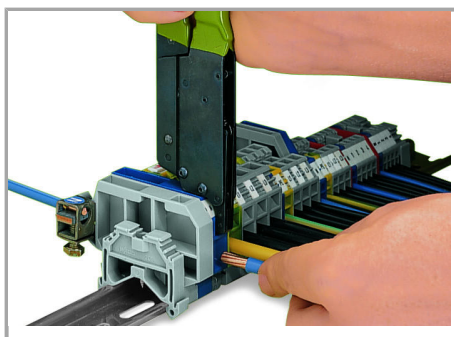

When operating the handles beyond the locked position, the ratchet allows the tool to open and be removed from the terminal block.



Labeling via WMB Multi Marking System.

Supus modificărilor.