

## Fișă tehnică | Număr articol: 769-195/769-319

1-conductor/1-conductor terminal block for pluggable modules; 10-pole; with 2-conductor terminal blocks; with 2 jumper positions; with orange separator plate; for DIN-rail 35 x 15 and 35 x 7.5; 4 mm<sup>2</sup>; CAGE CLAMP®; 4,00 mm<sup>2</sup>; gray

[www.wago.com/769-195/769-319](http://www.wago.com/769-195/769-319)

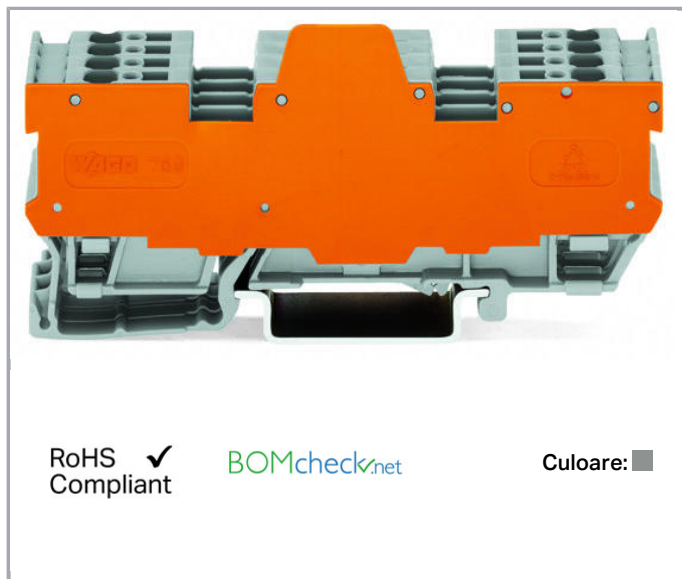

### Date

#### Electrical data

#### Ratings per IEC/EN 60664-1

|                             |   |
|-----------------------------|---|
| Nominal voltage (III/3)     | 400 V   |
| Rated surge voltage (III/3) | 6 kV  |
| Rated current               | 16 A  |
| Legend (ratings)            | (III / 3) ≙ Overvoltage category III / Pollution degree 3 |

#### Connection data

|                                   |  |
|-----------------------------------|--|
| Connection technology             | CAGE CLAMP®                                |
| Connectable conductor materials   | Copper                                     |
| Nominal cross-section             | 4 mm <sup>2</sup>                          |
| Solid conductor                   | 0.08 ... 4 mm <sup>2</sup> / 28 ... 12 AWG |
| Fine-stranded conductor           | 0.08 ... 4 mm <sup>2</sup> / 28 ... 12 AWG |
| Strip length                      | 8 ... 9 mm / 0.31 ... 0.35 inch            |
| Pole No.                          | 10   |
| Total number of connection points | 10   |

Supus modificărilor.

WAGO Kontakttechnik GmbH & Co. KG  
/Representative Office Romania  
Sos. Pipera-Tunari nr. 1/1  
building 1, 2nd floor | 077190 Voluntari, Ilfov  
Tel.: +40-(0)31 421 85 68 | Email: info-RO@wago.com

Aveți întrebări despre produsele noastre?  
Vă stăm la dispoziție pentru preluarea apelului la +40 (0) 31 421 85 68.



|                            |                    |
|----------------------------|--------------------|
| Total number of potentials | 10                 |
| Number of levels           | 1                  |
| Wiring type                | Front-entry wiring |

**Geometrical Data**

|                                    |                      |
|------------------------------------|----------------------|
| Width                              | 26.1 mm / 1.028 inch |
| Height from upper-edge of DIN-rail | 28.5 mm / 1.122 inch |
| Depth                              | 87.5 mm / 3.445 inch |

**Mechanical data**

|               |                |
|---------------|----------------|
| Design        | horizontal     |
| Mounting type | DIN-35 rail    |
| Marking level | Center marking |

**Material Data**

|                     |                      |
|---------------------|----------------------|
| Color               | gray                 |
| Insulation material | Polyamide 66 (PA 66) |
| Fire load           | 0,903 MJ             |
| Weight              | 44,3 g               |

**Commercial data**

|                       |                   |
|-----------------------|-------------------|
| Product Group         | 18 (X-COM-System) |
| Packaging type        | BOX               |
| Country of origin     | DE                |
| GTIN                  | 4017332096195     |
| Customs tariff number | 85369010000       |

**Aprobări / certificate**

## Country specific Approvals

| Emblemă  | Aprobare                               | Text de aprobare suplimentar | Nume certificat |
|--|--|------------------------------|-----------------|
|  | <b>CCA</b><br>DEKRA Certification B.V. | EN 60947                     | NTR NL-7626     |
|  | <b>CSA</b><br>DEKRA Certification B.V. | C22.2 No. 158                | 1101144         |

Supus modificărilor.

WAGO Kontakttechnik GmbH & Co. KG  
/Representative Office Romania  
Sos. Pipera-Tunari nr. 1/1  
building 1, 2nd floor | 077190 Voluntari, Ilfov  
Tel.: +40-(0)31 421 85 68 | Email: info-RO@wago.com

Aveți întrebări despre produsele noastre?  
Vă stăm la dispoziție pentru preluarea apelului la +40 (0) 31 421 85 68.



KEMA/KEUR



EN 60947

2190419.01





DEKRA Certification B.V.

## Ship Approvals

| Emblemă  | Aprobare  | Text de aprobare suplimentar | Nume certificat          |
|--|---|------------------------------|--------------------------|
|  | <b>ABS</b><br>American Bureau of Shipping               | EN 60947                     | 20-<br>HG1941090-<br>PDA |
|  | <b>DNV GL</b><br>Det Norske Veritas, Germanischer Lloyd | -                            | TAE00001V2               |

## UL-Approvals

| Emblemă  | Aprobare                                    | Text de aprobare suplimentar | Nume certificat     |
|--|---|------------------------------|---------------------|
|  | <b>UR</b><br>Underwriters Laboratories Inc. | UL 1059                      | 20190731-<br>E45172 |
|  | <b>UR</b><br>Underwriters Laboratories Inc. | UL 1977                      | 20151210-<br>E45171 |

## Counterpart









## Produse compatibile

Supus modificărilor.

WAGO Kontakttechnik GmbH & Co. KG  
/Representative Office Romania  
Sos. Pipera-Tunari nr. 1/1  
building 1, 2nd floor | 077190 Voluntari, Ilfov  
Tel.: +40-(0)31 421 85 68 | Email: info-RO@wago.com

Aveți întrebări despre produsele noastre?  
Vă stăm la dispoziție pentru preluarea apelului la +40 (0) 31 421 85 68.







## End plate

|  |   |  |
|--|---|--|
|    | <b>Nr. articol: 769-309</b><br>End and intermediate plate; 1.1 mm thick; gray   | <a href="http://www.wago.com/769-309">www.wago.com/769-309</a> |
|    | <b>Nr. articol: 769-310</b><br>End and intermediate plate; 1.1 mm thick; orange | <a href="http://www.wago.com/769-310">www.wago.com/769-310</a> |
|    | <b>Nr. articol: 769-311</b><br>End and intermediate plate; 1.1 mm thick; gray   | <a href="http://www.wago.com/769-311">www.wago.com/769-311</a> |
|    | <b>Nr. articol: 769-312</b><br>End and intermediate plate; 1.1 mm thick; orange | <a href="http://www.wago.com/769-312">www.wago.com/769-312</a> |
|    | <b>Nr. articol: 769-313</b><br>Separator plate; 1.1 mm thick; oversized; orange | <a href="http://www.wago.com/769-313">www.wago.com/769-313</a> |
|    | <b>Nr. articol: 769-314</b><br>Separator plate; 1.1 mm thick; oversized; orange | <a href="http://www.wago.com/769-314">www.wago.com/769-314</a> |
|    | <b>Nr. articol: 769-317</b><br>End and intermediate plate; 1.1 mm thick; gray   | <a href="http://www.wago.com/769-317">www.wago.com/769-317</a> |
|  | <b>Nr. articol: 769-318</b><br>End and intermediate plate; 1.1 mm thick; orange | <a href="http://www.wago.com/769-318">www.wago.com/769-318</a> |







## Protective Warning Marker

|  |  |  |
|--|--|--|
|  | <b>Nr. articol: 280-415</b><br>Protective warning marker; with high-voltage symbol, black; for 5 terminal blocks; yellow | <a href="http://www.wago.com/280-415">www.wago.com/280-415</a> |
|--|--|--|











## Jumper

|  |  |  |
|--|--|--|
|  | <b>Nr. articol: 249-123</b><br>Push-in type wire jumper; insulated; wire length 180 mm; Conductor cross section 0.75 mm <sup>2</sup> | <a href="http://www.wago.com/249-123">www.wago.com/249-123</a> |
|  | <b>Nr. articol: 249-125</b><br>Push-in type wire jumper; insulated; wire length 60 mm; Conductor cross section 0.75 mm <sup>2</sup>  | <a href="http://www.wago.com/249-125">www.wago.com/249-125</a> |
|  | <b>Nr. articol: 249-126</b><br>Push-in type wire jumper; insulated; wire length 110 mm; Conductor cross section 0.75 mm <sup>2</sup> | <a href="http://www.wago.com/249-126">www.wago.com/249-126</a> |
|  | <b>Nr. articol: 249-127</b><br>Push-in type wire jumper; insulated; wire length 250 mm; Conductor cross section 0.75 mm <sup>2</sup> | <a href="http://www.wago.com/249-127">www.wago.com/249-127</a> |
|  | <b>Nr. articol: 280-402</b><br>Adjacent jumper; insulated; IN = IN terminal block; gray  | <a href="http://www.wago.com/280-402">www.wago.com/280-402</a> |
|  | <b>Nr. articol: 280-409</b><br>Alternate jumper; insulated; IN = IN terminal block; gray   | <a href="http://www.wago.com/280-409">www.wago.com/280-409</a> |

Supus modificărilor.

|   |   |  |
|---|---|--|
|  | <b>Nr. articol: 780-452</b><br>Staggered jumper; insulated; from 1 to 2; Spacing: 5 mm; suitable for 2-conductor female plugs; gray | <a href="http://www.wago.com/780-452">www.wago.com/780-452</a> |
|  | <b>Nr. articol: 780-453</b><br>Staggered jumper; insulated; from 1 to 3; Spacing: 5 mm; suitable for 2-conductor female plugs; gray | <a href="http://www.wago.com/780-453">www.wago.com/780-453</a> |
|  | <b>Nr. articol: 780-454</b><br>Staggered jumper; insulated; from 1 to 4; Spacing: 5 mm; suitable for 2-conductor female plugs; gray | <a href="http://www.wago.com/780-454">www.wago.com/780-454</a> |
|  | <b>Nr. articol: 780-455</b><br>Staggered jumper; insulated; from 1 to 5; Spacing: 5 mm; suitable for 2-conductor female plugs; gray | <a href="http://www.wago.com/780-455">www.wago.com/780-455</a> |
|  | <b>Nr. articol: 780-456</b><br>Staggered jumper; insulated; from 1 to 6; Spacing: 5 mm; suitable for 2-conductor female plugs; gray | <a href="http://www.wago.com/780-456">www.wago.com/780-456</a> |
|  | <b>Nr. articol: 780-457</b><br>Staggered jumper; insulated; from 1 to 7; Spacing: 5 mm; suitable for 2-conductor female plugs; gray | <a href="http://www.wago.com/780-457">www.wago.com/780-457</a> |
|  | <b>Nr. articol: 780-458</b><br>Staggered jumper; insulated; from 1 to 8; Spacing: 5 mm; suitable for 2-conductor female plugs; gray | <a href="http://www.wago.com/780-458">www.wago.com/780-458</a> |

**Carrier rail**

|  |   |  |
|--|---|--|
|    | <b>Nr. articol: 210-112</b><br>Steel carrier rail; 35 x 7.5 mm; 1 mm thick; 2 m long; slotted; according to EN 60715; "Hole width 25 mm   | <a href="http://www.wago.com/210-112">www.wago.com/210-112</a> |
|    | <b>Nr. articol: 210-113</b><br>Steel carrier rail; 35 x 7.5 mm; 1 mm thick; 2 m long; unslotted; according to EN 60715                    | <a href="http://www.wago.com/210-113">www.wago.com/210-113</a> |
|  | <b>Nr. articol: 210-114</b><br>Steel carrier rail; 35 x 15 mm; 1.5 mm thick; 2 m long; unslotted; similar to EN 60715                     | <a href="http://www.wago.com/210-114">www.wago.com/210-114</a> |
|  | <b>Nr. articol: 210-115</b><br>Steel carrier rail; 35 x 7.5 mm; 1 mm thick; 2 m long; slotted; according to EN 60715; "Hole width 18 mm   | <a href="http://www.wago.com/210-115">www.wago.com/210-115</a> |
|  | <b>Nr. articol: 210-118</b><br>Steel carrier rail; 35 x 15 mm; 2.3 mm thick; 2 m long; unslotted; according to EN 60715                   | <a href="http://www.wago.com/210-118">www.wago.com/210-118</a> |
|  | <b>Nr. articol: 210-196</b><br>Aluminum carrier rail; 35 x 8.2 mm; 1.6 mm thick; 2 m long; unslotted; similar to EN 60715; silver-colored | <a href="http://www.wago.com/210-196">www.wago.com/210-196</a> |
|  | <b>Nr. articol: 210-197</b><br>Steel carrier rail; 35 x 15 mm; 1.5 mm thick; 2 m long; slotted; similar to EN 60715                       | <a href="http://www.wago.com/210-197">www.wago.com/210-197</a> |
|  | <b>Nr. articol: 210-198</b><br>Copper carrier rail; 35 x 15 mm; 2.3 mm thick; 2 m long; unslotted; according to EN 60715; copper-colored  | <a href="http://www.wago.com/210-198">www.wago.com/210-198</a> |
|  | <b>Nr. articol: 210-504</b><br>Steel carrier rail; 35 x 7.5 mm; 1 mm thick; 2 m long; slotted; galvanized; according to EN 60715          | <a href="http://www.wago.com/210-504">www.wago.com/210-504</a> |
|  | <b>Nr. articol: 210-505</b><br>Steel carrier rail; 35 x 7.5 mm; 1 mm thick; 2 m long; unslotted; galvanized; according to EN 60715        | <a href="http://www.wago.com/210-505">www.wago.com/210-505</a> |

Supus modificărilor.

WAGO Kontakttechnik GmbH & Co. KG  
/Representative Office Romania  
Sos. Pipera-Tunari nr. 1/1  
building 1, 2nd floor | 077190 Voluntari, Ilfov  
Tel.: +40-(0)31 421 85 68 | Email: info-RO@wago.com

Aveți întrebări despre produsele noastre?  
Vă stăm la dispoziție pentru preluarea apelului la +40 (0) 31 421 85 68.

|  |   |  |
|--|---|--|
|  | <b>Nr. articol: 210-506</b><br>Steel carrier rail; 35 x 15 mm; 1.5 mm thick; 2 m long; unslotted; galvanized; similar to EN 60715 | <a href="http://www.wago.com/210-506">www.wago.com/210-506</a> |
|--|---|--|

|  |   |  |
|--|---|--|
|  | <b>Nr. articol: 210-508</b><br>Steel carrier rail; 35 x 15 mm; 1.5 mm thick; 2 m long; slotted; galvanized; similar to EN 60715 | <a href="http://www.wago.com/210-508">www.wago.com/210-508</a> |
|--|---|--|

**General accessories**

|  |   |  |
|--|---|--|
|  | <b>Nr. articol: 286-113</b><br>Empty component plug housing; Type 12; 25 mm wide; 10-pole; gray | <a href="http://www.wago.com/286-113">www.wago.com/286-113</a> |
|--|---|--|

|  |  |  |
|--|--|--|
|  | <b>Nr. articol: 286-336/001-000</b><br>Relay module; Nominal input voltage: 24 VDC; 2 break and 2 make contacts; Red status indicator; Module width: 25 mm; gray | <a href="http://www.wago.com/286-336/001-000">www.wago.com/286-336/001-000</a> |
|--|--|--|

|  |  |  |
|--|--|--|
|  | <b>Nr. articol: 286-344/004-000</b><br>Relay module; Nominal input voltage: 24 VDC; 3 break contacts and 1 make contact; Path; Red status indicator; Module width: 25 mm; gray | <a href="http://www.wago.com/286-344/004-000">www.wago.com/286-344/004-000</a> |
|--|--|--|

|  |  |  |
|--|--|--|
|  | <b>Nr. articol: 286-352/004-000</b><br>Relay module; Nominal input voltage: 24 VDC; 4 make contacts; Limiting continuous current: 5 A; Path; Red status indicator; Module width: 25 mm; gray | <a href="http://www.wago.com/286-352/004-000">www.wago.com/286-352/004-000</a> |
|--|--|--|

|  |  |  |
|--|--|--|
|  | <b>Nr. articol: 286-664</b><br>Current flow monitoring module; AC currents; Monitoring range: 1 A – 10 A; 1 changeover contact; light gray | <a href="http://www.wago.com/286-664">www.wago.com/286-664</a> |
|--|--|--|

|   |  |  |
|---|--|--|
|  | <b>Nr. articol: 286-665</b><br>Current flow monitoring module; AC currents; Monitoring range: 1 A – 10 A; 1 changeover contact; light gray | <a href="http://www.wago.com/286-665">www.wago.com/286-665</a> |
|---|--|--|

|  |  |  |
|--|--|--|
|  | <b>Nr. articol: 286-742</b><br>S0 interface power supply; Input voltage: 230 VAC; S0 interface | <a href="http://www.wago.com/286-742">www.wago.com/286-742</a> |
|--|--|--|

|  |  |  |
|--|--|--|
|  | <b>Nr. articol: 286-809</b><br>Component module with diode; light gray | <a href="http://www.wago.com/286-809">www.wago.com/286-809</a> |
|--|--|--|

|  |  |  |
|--|--|--|
|  | <b>Nr. articol: 286-822</b><br>Component module with LED; Red LED; with common cathode | <a href="http://www.wago.com/286-822">www.wago.com/286-822</a> |
|--|--|--|

|  |  |  |
|--|--|--|
|  | <b>Nr. articol: 286-826</b><br>AND gate module with 6 inputs; light gray | <a href="http://www.wago.com/286-826">www.wago.com/286-826</a> |
|--|--|--|

|  |  |  |
|--|--|--|
|  | <b>Nr. articol: 286-841</b><br>Surge suppression module for signal technology; Nominal voltage: 220 VDC; for 2 signal paths with common surge arrester; pluggable on rail-mount terminal block, 25 mm wide; gray | <a href="http://www.wago.com/286-841">www.wago.com/286-841</a> |
|--|--|--|

|  |  |  |
|--|--|--|
|  | <b>Nr. articol: 286-842</b><br>Surge suppression module for signal technology; Nominal voltage: 230 VAC; for 2 signal paths with common surge arrester; pluggable on rail-mount terminal block, 25 mm wide; gray | <a href="http://www.wago.com/286-842">www.wago.com/286-842</a> |
|--|--|--|

|  |  |  |
|--|--|--|
|  | <b>Nr. articol: 286-843</b><br>Surge suppression module for signal technology; Nominal voltage: 115 VAC; for 2 signal paths with common surge arrester; pluggable on rail-mount terminal block, 25 mm wide; gray | <a href="http://www.wago.com/286-843">www.wago.com/286-843</a> |
|--|--|--|

|  |  |  |
|--|--|--|
|  | <b>Nr. articol: 286-844</b><br>Surge suppression module for signal technology; for 2 signal paths with common surge arrester; pluggable on rail-mount terminal block, 25 mm wide; gray | <a href="http://www.wago.com/286-844">www.wago.com/286-844</a> |
|--|--|--|

Supus modificărilor.

WAGO Kontakttechnik GmbH & Co. KG  
/Representative Office Romania  
Sos. Pipera-Tunari nr. 1/1  
building 1, 2nd floor | 077190 Voluntari, Ilfov  
Tel.: +40-(0)31 421 85 68 | Email: info-RO@wago.com

Aveți întrebări despre produsele noastre?  
Vă stăm la dispoziție pentru preluarea apelului la +40 (0) 31 421 85 68.

|  |  |  |
|--|--|--|
|  | <b>Nr. articol: 769-438</b><br>Pin cover; with marker slot for miniature WSB; gray | <a href="http://www.wago.com/769-438">www.wago.com/769-438</a> |
|--|--|--|

|  |  |  |
|--|--|--|
|  | <b>Nr. articol: 769-439</b><br>Pin cover; with marker slot for miniature WSB; orange | <a href="http://www.wago.com/769-439">www.wago.com/769-439</a> |
|--|--|--|

|  |   |  |
|--|---|--|
|  | <b>Nr. articol: 786-103</b><br>Empty component plug housing; Type 16; 25 mm wide; 10-pole; gray | <a href="http://www.wago.com/786-103">www.wago.com/786-103</a> |
|--|---|--|

## tools

|  |  |  |
|--|--|--|
|  | <b>Nr. articol: 210-720</b><br>Operating tool; Blade: 3.5 x 0.5 mm; with a partially insulated shaft | <a href="http://www.wago.com/210-720">www.wago.com/210-720</a> |
|--|--|--|

## check

|  |  |  |
|--|--|--|
|  | <b>Nr. articol: 210-136</b><br>Test plug; 2 mm Ø; with 500 mm cable; red | <a href="http://www.wago.com/210-136">www.wago.com/210-136</a> |
|--|--|--|

|  |   |  |
|--|---|--|
|  | <b>Nr. articol: 210-137</b><br>Test plug; 2.3 mm Ø; with 500 mm cable; yellow | <a href="http://www.wago.com/210-137">www.wago.com/210-137</a> |
|--|---|--|

|  |   |  |
|--|---|--|
|  | <b>Nr. articol: 280-404</b><br>Test plug adapter; 5 mm wide; for test plug 210-137 (2.3 mm Ø); suitable for 1.5 mm <sup>2</sup> - 4 mm <sup>2</sup> tbs; gray | <a href="http://www.wago.com/280-404">www.wago.com/280-404</a> |
|--|---|--|

|  |  |  |
|--|--|--|
|  | <b>Nr. articol: 280-418</b><br>Test plug module; modular; suitable for all WAGO 280 and 780 Series rail-mounted terminal blocks with jumper slots in the current bar; gray | <a href="http://www.wago.com/280-418">www.wago.com/280-418</a> |
|--|--|--|

|  |  |  |
|--|--|--|
|  | <b>Nr. articol: 280-419</b><br>Spacer module; modular; bridging commoned terminal blocks; gray | <a href="http://www.wago.com/280-419">www.wago.com/280-419</a> |
|--|--|--|

## Marking accessories

|  |   |  |
|--|---|--|
|  | <b>Nr. articol: 2009-145</b><br>Mini-WSB Inline; for Smart Printer; 1700 pieces on roll; stretchable 5 - 5.2 mm; plain; snap-on type; white | <a href="http://www.wago.com/2009-145">www.wago.com/2009-145</a> |
|--|---|--|

|  |  |  |
|--|--|--|
|  | <b>Nr. articol: 2009-145/000-002</b><br>Mini-WSB Inline; for Smart Printer; 1700 pieces on roll; stretchable 5 - 5.2 mm; plain; snap-on type; yellow | <a href="http://www.wago.com/2009-145/000-002">www.wago.com/2009-145/000-002</a> |
|--|--|--|

|  |   |  |
|--|---|--|
|  | <b>Nr. articol: 2009-145/000-005</b><br>Mini-WSB Inline; for Smart Printer; 1700 pieces on roll; stretchable 5 - 5.2 mm; plain; snap-on type; red | <a href="http://www.wago.com/2009-145/000-005">www.wago.com/2009-145/000-005</a> |
|--|---|--|

|  |  |  |
|--|--|--|
|  | <b>Nr. articol: 2009-145/000-006</b><br>Mini-WSB Inline; for Smart Printer; 1700 pieces on roll; stretchable 5 - 5.2 mm; plain; snap-on type; blue | <a href="http://www.wago.com/2009-145/000-006">www.wago.com/2009-145/000-006</a> |
|--|--|--|

|  |  |  |
|--|--|--|
|  | <b>Nr. articol: 2009-145/000-007</b><br>Mini-WSB Inline; for Smart Printer; 1700 pieces on roll; stretchable 5 - 5.2 mm; plain; snap-on type; gray | <a href="http://www.wago.com/2009-145/000-007">www.wago.com/2009-145/000-007</a> |
|--|--|--|

|  |   |  |
|--|---|--|
|  | <b>Nr. articol: 2009-145/000-012</b><br>Mini-WSB Inline; for Smart Printer; 1700 pieces on roll; stretchable 5 - 5.2 mm; plain; snap-on type; | <a href="http://www.wago.com/2009-145/000-012">www.wago.com/2009-145/000-012</a> |
|--|---|--|

Supus modificărilor.

orange



**Nr. articol:** 2009-145/000-023

Mini-WSB Inline; for Smart Printer; 1700 pieces on roll; stretchable 5 - 5.2 mm; plain; snap-on type; green

[www.wago.com/2009-145/000-023](http://www.wago.com/2009-145/000-023)



**Nr. articol:** 2009-145/000-024

Mini-WSB Inline; for Smart Printer; 1700 pieces on roll; stretchable 5 - 5.2 mm; plain; snap-on type; violet

[www.wago.com/2009-145/000-024](http://www.wago.com/2009-145/000-024)



**Nr. articol:** 248-501

Miniature WSB Quick marking system; plain; Marker width 5 mm; 10 strips with 10 markers per card

[www.wago.com/248-501](http://www.wago.com/248-501)



**Nr. articol:** 248-501/000-002

Mini-WSB marking card; as card; not stretchable; plain; snap-on type; yellow

[www.wago.com/248-501/000-002](http://www.wago.com/248-501/000-002)



**Nr. articol:** 248-501/000-005

Mini-WSB marking card; as card; not stretchable; plain; snap-on type; red

[www.wago.com/248-501/000-005](http://www.wago.com/248-501/000-005)



**Nr. articol:** 248-501/000-006

Mini-WSB marking card; as card; not stretchable; plain; snap-on type; blue

[www.wago.com/248-501/000-006](http://www.wago.com/248-501/000-006)



**Nr. articol:** 248-501/000-007

Mini-WSB marking card; as card; not stretchable; plain; snap-on type; gray

[www.wago.com/248-501/000-007](http://www.wago.com/248-501/000-007)



**Nr. articol:** 248-501/000-012

Mini-WSB marking card; as card; not stretchable; plain; snap-on type; orange

[www.wago.com/248-501/000-012](http://www.wago.com/248-501/000-012)



**Nr. articol:** 248-501/000-017

Mini-WSB marking card; as card; not stretchable; plain; snap-on type; light green

[www.wago.com/248-501/000-017](http://www.wago.com/248-501/000-017)



**Nr. articol:** 248-501/000-023

Mini-WSB marking card; as card; not stretchable; plain; snap-on type; green

[www.wago.com/248-501/000-023](http://www.wago.com/248-501/000-023)



**Nr. articol:** 248-501/000-024

Mini-WSB marking card; as card; not stretchable; plain; snap-on type; violet

[www.wago.com/248-501/000-024](http://www.wago.com/248-501/000-024)

#### Insulation stop



**Nr. articol:** 769-470

Insulation stop; 0.08 - 0.2 mm<sup>2</sup> "s" (0.14 mm<sup>2</sup> "f-st"); 5 pieces/strip; white

[www.wago.com/769-470](http://www.wago.com/769-470)



**Nr. articol:** 769-471

Insulation stop; 0.25 - 0.5 mm<sup>2</sup>; 5 pieces/strip; light gray

[www.wago.com/769-471](http://www.wago.com/769-471)

**Nr. articol:** 769-472

Insulation stop; 0.75 - 1 mm<sup>2</sup>; 5 pieces/strip; dark gray

[www.wago.com/769-472](http://www.wago.com/769-472)

Supus modificărilor.





## Coding



Nr. articol: 769-435

Coding pin; for coding of female plugs; for carrier terminal blocks / male connectors; orange

[www.wago.com/769-435](http://www.wago.com/769-435)

## assembling



Nr. articol: 209-106

Mounting carrier; for isolated mounting on DIN 35 rails; gray

[www.wago.com/209-106](http://www.wago.com/209-106)

## ferrule



Nr. articol: 216-101

Ferrule; Sleeve for 0.5 mm<sup>2</sup> / AWG 22; uninsulated; electro-tin plated[www.wago.com/216-101](http://www.wago.com/216-101)

Nr. articol: 216-102

Ferrule; Sleeve for 0.75 mm<sup>2</sup> / AWG 20; uninsulated; electro-tin plated[www.wago.com/216-102](http://www.wago.com/216-102)

Nr. articol: 216-103

Ferrule; Sleeve for 1 mm<sup>2</sup> / AWG 18; uninsulated; electro-tin plated[www.wago.com/216-103](http://www.wago.com/216-103)

Nr. articol: 216-104

Ferrule; Sleeve for 1.5 mm<sup>2</sup> / AWG 16; uninsulated; electro-tin plated[www.wago.com/216-104](http://www.wago.com/216-104)

Nr. articol: 216-201

Ferrule; Sleeve for 0.5 mm<sup>2</sup> / 20 AWG; insulated; electro-tin plated; white[www.wago.com/216-201](http://www.wago.com/216-201)

Nr. articol: 216-202

Ferrule; Sleeve for 0.75 mm<sup>2</sup> / 18 AWG; insulated; electro-tin plated; gray[www.wago.com/216-202](http://www.wago.com/216-202)

Nr. articol: 216-203

Ferrule; Sleeve for 1 mm<sup>2</sup> / AWG 18; insulated; electro-tin plated; red[www.wago.com/216-203](http://www.wago.com/216-203)

Nr. articol: 216-204

Ferrule; Sleeve for 1.5 mm<sup>2</sup> / AWG 16; insulated; electro-tin plated; black[www.wago.com/216-204](http://www.wago.com/216-204)

Nr. articol: 216-206

Ferrule; Sleeve for 2.5 mm<sup>2</sup> / AWG 14; insulated; electro-tin plated; blue[www.wago.com/216-206](http://www.wago.com/216-206)

Nr. articol: 216-301

Ferrule; Sleeve for 0.25 mm<sup>2</sup> / AWG 24; insulated; electro-tin plated; yellow[www.wago.com/216-301](http://www.wago.com/216-301)

Nr. articol: 216-302

Ferrule; Sleeve for 0.34 mm<sup>2</sup> / 22 AWG; insulated; electro-tin plated; green[www.wago.com/216-302](http://www.wago.com/216-302)

## Descărcări

## Documentation

## Additional Information

Technical explanations

Apr 3, 2019

pdf  
2,1 MB

Descărcare

Supus modificărilor.

WAGO Kontakttechnik GmbH & Co. KG  
/Representative Office Romania  
Sos. Pipera-Tunari nr. 1/1  
building 1, 2nd floor | 077190 Voluntari, Ilfov  
Tel.: +40-(0)31 421 85 68 | Email: info-RO@wago.com

Aveți întrebări despre produsele noastre?  
Vă stăm la dispoziție pentru preluarea apelului la +40 (0) 31 421 85 68.

## CAD/CAE-Data

### CAD data

|                              |                     |                            |
|------------------------------|---------------------|----------------------------|
| 2D/3D Models 769-195/769-319 | <a href="#">URL</a> | <a href="#">Descărcare</a> |
|------------------------------|---------------------|----------------------------|

### CAE data

|                                   |                     |                            |
|-----------------------------------|---------------------|----------------------------|
| EPLAN Data Portal 769-195/769-319 | <a href="#">URL</a> | <a href="#">Descărcare</a> |
|-----------------------------------|---------------------|----------------------------|

|                                |                     |                            |
|--------------------------------|---------------------|----------------------------|
| WSCAD Universe 769-195/769-319 | <a href="#">URL</a> | <a href="#">Descărcare</a> |
|--------------------------------|---------------------|----------------------------|

## Installation Notes

### Installation

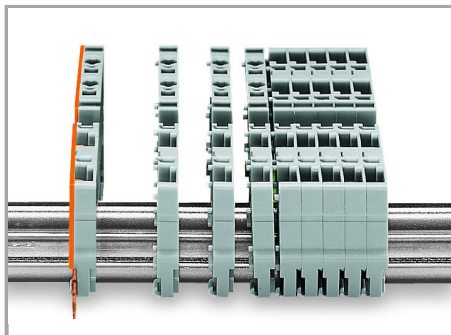

Snap individual carrier terminal blocks onto the carrier rail and slide together.

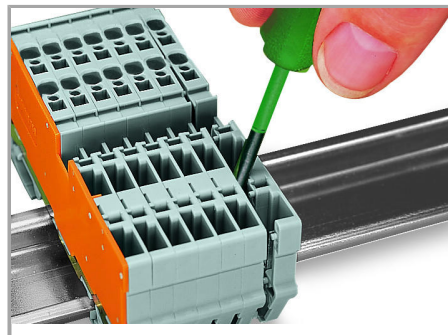

Open the assembly by laterally sliding a block via operating tool and remove terminal block via release lever.

### Conductor termination

Supus modificărilor.

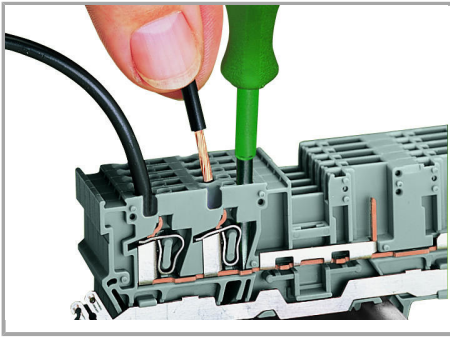

CAGE CLAMP® connection

Carrier terminal block: Insert/remove conductor via operating tool (3.5 x 0.5 mm blade).

### Commoning

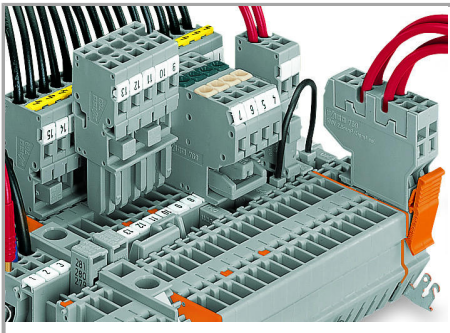

Commoning with adjacent or staggered jumpers –

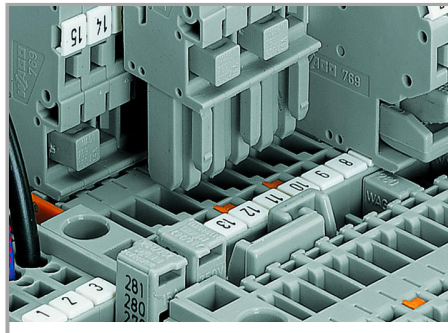

Commoning carrier terminal blocks via staggered jumpers.

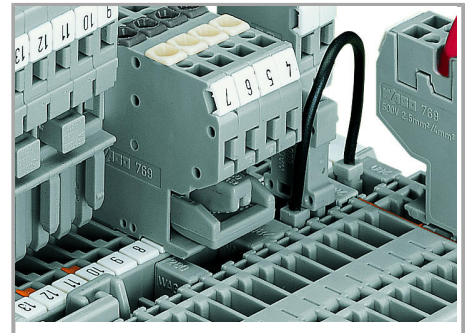

Commoning a 2-conductor female plug via staggered jumper and carrier terminal blocks via adjacent jumpers.

push jumpers down until fully inserted.

Supus modificărilor.

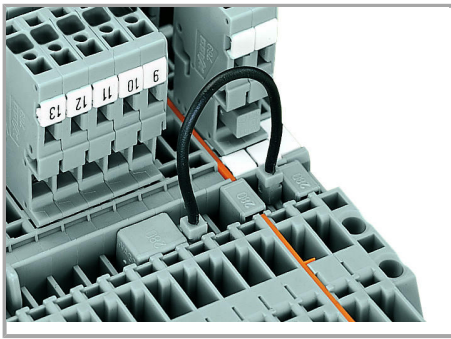

Commoning carrier terminal blocks via push-in type wire jumpers or adjacent jumpers – even over an intermediate plate.

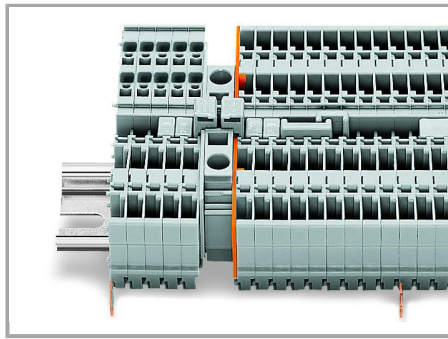

Commoning “supply terminal blocks” (up to 10 mm<sup>2</sup>/8 AWG) with carrier terminal blocks via step-down jumpers.

### Testing

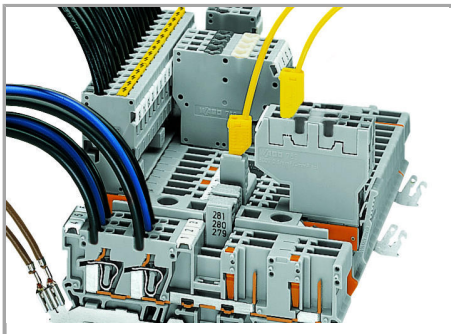

Testing via 2 or 2.3 mm Ø test plugs.

### Coding

Supus modificărilor.

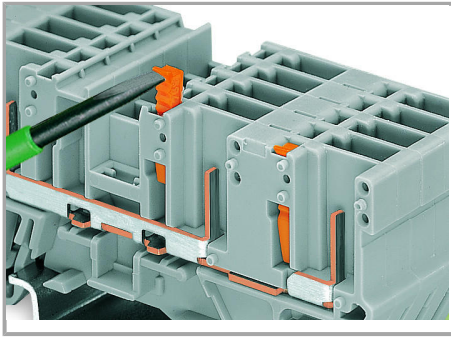

Snap coding pin in proper direction on carrier terminal block.

Shown: Coding pin removal from carrier terminal block.

#### Locking lever

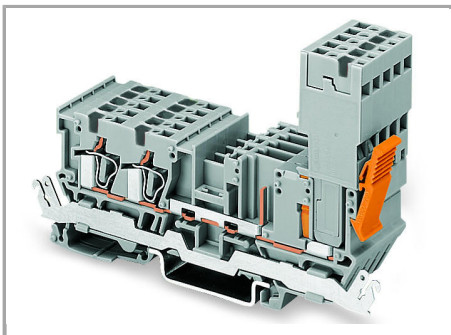

Female plug secured with locking lever on the terminal block side.

#### Familie de produse

##### X-COM

[Afișare globală produse din familie.](#)

Supus modificărilor.