

Fișă tehnică | Număr articol: 769-183/769-314

1-conductor/1-pin terminal block for pluggable modules; 6-pole; with 2 jumper positions; with orange separator plate; for DIN-rail 35 x 15 and 35 x 7.5; 4 mm²; CAGE CLAMP®; 4,00 mm²; gray

www.wago.com/769-183/769-314

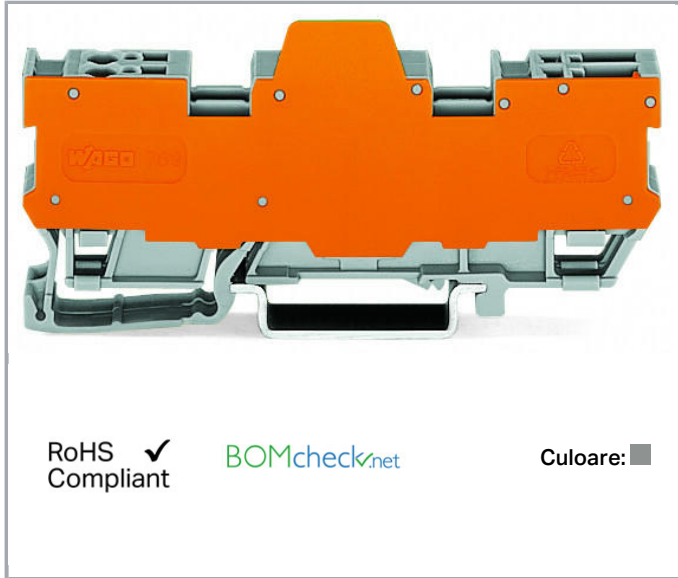

Date

Electrical data

Ratings per IEC/EN 60664-1

| | |
|-----------------------------|---|
| Nominal voltage (III/3) | 400 V |
| Rated surge voltage (III/3) | 6 kV |
| Rated current | 16 A |
| Legend (ratings) | (III / 3) ≙ Overvoltage category III / Pollution degree 3 |

Connection data

| | |
|---------------------------------|--|
| Connection technology | CAGE CLAMP® |
| Actuation type | Open Tool Slot |
| Connectable conductor materials | Copper |
| Nominal cross-section | 4 mm ² |
| Solid conductor | 0.08 ... 4 mm ² / 28 ... 12 AWG |
| Fine-stranded conductor | 0.08 ... 4 mm ² / 28 ... 12 AWG |
| Strip length | 8 ... 9 mm / 0.31 ... 0.35 inch |
| Pole No. | 6 |

Supus modificărilor.

WAGO Kontakttechnik GmbH & Co. KG
/Representative Office Romania
Sos. Pipera-Tunari nr. 1/1
building 1, 2nd floor | 077190 Voluntari, Ilfov
Tel.: +40-(0)31 421 85 68 | Email: info-RO@wago.com

Aveți întrebări despre produsele noastre?
Vă stăm la dispoziție pentru preluarea apelului la +40 (0) 31 421 85 68.



| | |
|-----------------------------------|--------------------|
| Total number of connection points | 3 |
| Total number of potentials | 6 |
| Number of levels | 1 |
| Wiring type | Front-entry wiring |

Geometrical Data

| | |
|------------------------------------|----------------------|
| Width | 16.1 mm / 0.634 inch |
| Height from upper-edge of DIN-rail | 28.5 mm / 1.122 inch |
| Depth | 87.5 mm / 3.445 inch |

Mechanical data

| | |
|---------------|----------------|
| Design | horizontal |
| Mounting type | DIN-35 rail |
| Marking level | Center marking |

Material Data

| | |
|---------------------|----------------------|
| Color | gray |
| Insulation material | Polyamide 66 (PA 66) |
| Fire load | 0,572 MJ |
| Weight | 27,2 g |

Commercial data

| | |
|-----------------------|-------------------|
| Product Group | 18 (X-COM-System) |
| Packaging type | BOX |
| Country of origin | DE |
| GTIN | 4044918934862 |
| Customs tariff number | 85369010000 |

Aprobări / certificate**Country specific Approvals**

| Emblemă | Aprobare | Text de aprobare suplimentar | Nume certificat |
|--|---------------------------------|------------------------------|-----------------|
|  | CCA DEKRA Certification B.V. | EN 60947 | NTR NL- 7626 |
| | CSA | C22.2 No. 158 | 1101144 |

Supus modificărilor.

WAGO Kontakttechnik GmbH & Co. KG
/Representative Office Romania
Sos. Pipera-Tunari nr. 1/1
building 1, 2nd floor | 077190 Voluntari, Ilfov
Tel.: +40-(0)31 421 85 68 | Email: info-RO@wago.com

Aveți întrebări despre produsele noastre?
Vă stăm la dispoziție pentru preluarea apelului la +40 (0) 31 421 85 68.



DEKRA Certification B.V.





KEMA/KEUR

DEKRA Certification B.V.



EN 60947

2190419.01

Ship Approvals

| Emblemă | Aprobare | Text de aprobare suplimentar | Nume certificat |
|--|---|------------------------------|--------------------------|
|  | ABS American Bureau of Shipping | EN 60947 | 20- HG1941090- PDA |
|  | DNV GL Det Norske Veritas, Germanischer Lloyd | - | TAE00001V2 |

UL-Approvals

| Emblemă | Aprobare | Text de aprobare suplimentar | Nume certificat |
|--|---|------------------------------|---------------------|
|  | UR Underwriters Laboratories Inc. | UL 1059 | 20190731- E45172 |
|  | UR Underwriters Laboratories Inc. | UL 1977 | 20151210- E45171 |

Counterpart

Produse compatibile

Supus modificărilor.

WAGO Kontakttechnik GmbH & Co. KG
 /Representative Office Romania
 Sos. Pipera-Tunari nr. 1/1
 building 1, 2nd floor | 077190 Voluntari, Ilfov
 Tel.: +40-(0)31 421 85 68 | Email: info-RO@wago.com

Aveți întrebări despre produsele noastre?
 Vă stăm la dispoziție pentru preluarea apelului la +40 (0) 31 421 85 68.

assembling



Nr. articol: 209-106
Mounting carrier; for isolated mounting on DIN 35 rails; gray

www.wago.com/209-106

Protective Warning Marker



Nr. articol: 280-415
Protective warning marker; with high-voltage symbol, black; for 5 terminal blocks; yellow

www.wago.com/280-415

check



Nr. articol: 210-136
Test plug; 2 mm Ø; with 500 mm cable; red

www.wago.com/210-136



Nr. articol: 210-137
Test plug; 2.3 mm Ø; with 500 mm cable; yellow

www.wago.com/210-137



Nr. articol: 280-404
Test plug adapter; 5 mm wide; for test plug 210-137 (2.3 mm Ø); suitable for 1.5 mm² - 4 mm² tbs; gray

www.wago.com/280-404



Nr. articol: 280-418
Test plug module; modular; suitable for all WAGO 280 and 780 Series rail-mounted terminal blocks with jumper slots in the current bar; gray

www.wago.com/280-418



Nr. articol: 280-419
Spacer module; modular; bridging commoned terminal blocks; gray

www.wago.com/280-419

General accessories



Nr. articol: 286-111
Empty component plug housing; Type 10; 15 mm wide; 6-pole; gray

www.wago.com/286-111



Nr. articol: 286-113
Empty component plug housing; Type 12; 25 mm wide; 10-pole; gray

www.wago.com/286-113



Nr. articol: 286-304
Relay module; Nominal input voltage: 24 VDC; 1 changeover contact; Limiting continuous current: 7 A; Red status indicator; Module width: 15 mm; gray

www.wago.com/286-304



Nr. articol: 286-304/004-000
Relay module; Nominal input voltage: 24 VDC; 1 changeover contact; Limiting continuous current: 7 A; Path; Red status indicator; Module width: 15 mm; gray

www.wago.com/286-304/004-000















Nr. articol: 286-307/004-000
Relay module; Nominal input voltage: 110 VDC; 1 changeover contact; Limiting continuous current: 7 A; Path; Red status indicator; Module width: 15 mm; gray

















www.wago.com/286-307/004-000

Nr. articol: 286-336/001-000















Supus modificărilor.

| | | |
|--|--|--|
|  | Relay module; Nominal input voltage: 24 VDC; 2 break and 2 make contacts; Red status indicator; Module width: 25 mm; gray | www.wago.com/286-336/001-000 |
|  | Nr. articol: 286-344/004-000 Relay module; Nominal input voltage: 24 VDC; 3 break contacts and 1 make contact; Path; Red status indicator; Module width: 25 mm; gray | www.wago.com/286-344/004-000 |
|  | Nr. articol: 286-352/004-000 Relay module; Nominal input voltage: 24 VDC; 4 make contacts; Limiting continuous current: 5 A; Path; Red status indicator; Module width: 25 mm; gray | www.wago.com/286-352/004-000 |
|  | Nr. articol: 286-376 Relay module; Nominal input voltage: 24 VDC; 1 make contact; Limiting continuous current: 5 A; for switching higher DC loads; Red status indicator; Module width: 15 mm; gray | www.wago.com/286-376 |
|  | Nr. articol: 286-380 Bistable relay module; Nominal input voltage: 24 VDC; 1 changeover contact; Limiting continuous current: 6 A; Red status indicator; Module width: 15 mm; gray | www.wago.com/286-380 |
|  | Nr. articol: 286-381 Bistable relay module; Nominal input voltage: 24 VDC; 1 changeover contact; Limiting continuous current: 6 A; Red status indicator; Module width: 15 mm; gray | www.wago.com/286-381 |
|  | Nr. articol: 286-394/004-000 Relay module; Nominal input voltage: 24 VDC; 1 changeover contact; Path; Red status indicator; Module width: 15 mm; light gray | www.wago.com/286-394/004-000 |
|  | Nr. articol: 286-507 Relay module; Nominal input voltage: 115 VAC; 1 changeover contact; Limiting continuous current: 7 A; Red status indicator; Module width: 15 mm; gray | www.wago.com/286-507 |
|  | Nr. articol: 286-508 Relay module; Nominal input voltage: 230 VAC; 1 changeover contact; Limiting continuous current: 7 A; Red status indicator; Module width: 15 mm; gray | www.wago.com/286-508 |
|  | Nr. articol: 286-573 Latching relay module; Nominal input voltage: 24 VDC; 1 changeover contact; Limiting continuous current: 6 A; Red status indicator; Module width: 15 mm | www.wago.com/286-573 |
|  | Nr. articol: 286-662 Current flow monitoring module; DC currents; Monitoring range: 0.4 A – 3.5 A; 1 make contact; light gray | www.wago.com/286-662 |
|  | Nr. articol: 286-664 Current flow monitoring module; AC currents; Monitoring range: 1 A – 10 A; 1 changeover contact; light gray | www.wago.com/286-664 |
|  | Nr. articol: 286-665 Current flow monitoring module; AC currents; Monitoring range: 1 A – 10 A; 1 changeover contact; light gray | www.wago.com/286-665 |
|  | Nr. articol: 286-721 Optocoupler module; Nominal input voltage: 24 VDC; Output voltage range: 15 ... 30 VDC; Limiting continuous current: 5 A; 3-wire connection/low-side switching; Red status indicator; Module width: 15 mm; gray | www.wago.com/286-721 |
| | Nr. articol: 286-723 Optocoupler module; Nominal input voltage: 24 VDC; Output voltage range: 15 ... 30 VDC; Limiting | |















Supus modificărilor.

| | | |
|--|--|--|
|  | continuous current: 4 A; 3-wire connection/high-side switching; Red status indicator; Module width: 15 mm; gray | www.wago.com/286-723 |
|  | Nr. articol: 286-725 Optocoupler module; Input AC/DC 10 V ... 30 V; Output DC 24 V/ 1 mA ... 0.5 A; negative switching; gray | www.wago.com/286-725 |
|  | Nr. articol: 286-742 S0 interface power supply; Input voltage: 230 VAC; S0 interface | www.wago.com/286-742 |
|  | Nr. articol: 286-752 Optocoupler module; Nominal input voltage: 24 VDC; Output voltage range: 20 ... 30 VDC; Limiting continuous current: 0.5 A; 3-wire connection/high-side switching; Frequency: 25 kHz; Red status indicator; Module width: 15 mm; gray | www.wago.com/286-752 |
|  | Nr. articol: 286-752/002-000 Optocoupler module; Red status indicator; gray | www.wago.com/286-752/002-000 |
|  | Nr. articol: 286-805 Component module with diode; light gray | www.wago.com/286-805 |
|  | Nr. articol: 286-809 Component module with diode; light gray | www.wago.com/286-809 |
|  | Nr. articol: 286-822 Component module with LED; Red LED; with common cathode | www.wago.com/286-822 |
|  | Nr. articol: 286-826 AND gate module with 6 inputs; light gray | www.wago.com/286-826 |
|  | Nr. articol: 286-830 Bridge rectifier module; Input voltage: 24 VAC; with varistor protective circuit; gray | www.wago.com/286-830 |
|  | Nr. articol: 286-840 Bridge rectifier module; Input voltage: 250 VAC; with varistor protective circuit; gray | www.wago.com/286-840 |
|  | Nr. articol: 286-841 Surge suppression module for signal technology; Nominal voltage: 220 VDC; for 2 signal paths with common surge arrester; pluggable on rail-mount terminal block, 25 mm wide; gray | www.wago.com/286-841 |
|  | Nr. articol: 286-842 Surge suppression module for signal technology; Nominal voltage: 230 VAC; for 2 signal paths with common surge arrester; pluggable on rail-mount terminal block, 25 mm wide; gray | www.wago.com/286-842 |
|  | Nr. articol: 286-843 Surge suppression module for signal technology; Nominal voltage: 115 VAC; for 2 signal paths with common surge arrester; pluggable on rail-mount terminal block, 25 mm wide; gray | www.wago.com/286-843 |
|  | Nr. articol: 286-844 Surge suppression module for signal technology; for 2 signal paths with common surge arrester; pluggable on rail-mount terminal block, 25 mm wide; gray | www.wago.com/286-844 |
|  | Nr. articol: 286-895 Switching module; with changeover rocker switch; Switching voltage: 250 VAC; Switching current: 6 A; gray | www.wago.com/286-895 |
| | Nr. articol: 286-896 | |















Supus modificărilor.

| | | |
|--|--|--|
|  | Switching module; with momentary switch; Switching voltage: 250 VAC; Switching current: 6 A; gray | www.wago.com/286-896 |
|  | Nr. articol: 769-438 Pin cover; with marker slot for miniature WSB; gray | www.wago.com/769-438 |
|  | Nr. articol: 769-439 Pin cover; with marker slot for miniature WSB; orange | www.wago.com/769-439 |
|  | Nr. articol: 769-501 Start module for 1-conductor female connector; with integrated end plate; 4 mm ² ; 1-pole; 4,00 mm ² ; gray | www.wago.com/769-501 |
|  | Nr. articol: 769-501/000-006 Start module for 1-conductor female connector; 4 mm ² ; 1-pole; 4,00 mm ² ; blue | www.wago.com/769-501/000-006 |
|  | Nr. articol: 769-501/000-016 Start module for 1-conductor female connector; with integrated end plate; 4 mm ² ; 1-pole; 4,00 mm ² ; green-yellow | www.wago.com/769-501/000-016 |
|  | Nr. articol: 769-502 Center module for 1-conductor female connector; 4 mm ² ; 1-pole; 4,00 mm ² ; gray | www.wago.com/769-502 |
|  | Nr. articol: 769-502/000-006 Center module for 1-conductor female connector; 4 mm ² ; 1-pole; 4,00 mm ² ; blue | www.wago.com/769-502/000-006 |
|  | Nr. articol: 769-502/000-016 Center module for 1-conductor female connector; 4 mm ² ; 1-pole; 4,00 mm ² ; green-yellow | www.wago.com/769-502/000-016 |
|  | Nr. articol: 769-503 End module for 1-conductor female connector; 4 mm ² ; 1-pole; 4,00 mm ² ; gray | www.wago.com/769-503 |
|  | Nr. articol: 769-503/000-006 End module for 1-conductor female connector; 4 mm ² ; 1-pole; 4,00 mm ² ; blue | www.wago.com/769-503/000-006 |
|  | Nr. articol: 769-503/000-016 End module for 1-conductor female connector; 4 mm ² ; 1-pole; 4,00 mm ² ; green-yellow | www.wago.com/769-503/000-016 |
|  | Nr. articol: 769-512 Start module for 1-conductor female connector; angled; 4 mm ² ; 1-pole; 4,00 mm ² ; gray | www.wago.com/769-512 |
|  | Nr. articol: 769-512/000-006 Start module for 1-conductor female connector; angled; 4 mm ² ; 1-pole; 4,00 mm ² ; blue | www.wago.com/769-512/000-006 |
|  | Nr. articol: 769-512/000-016 Start module for 1-conductor female connector; angled; 4 mm ² ; 1-pole; 4,00 mm ² ; green-yellow | www.wago.com/769-512/000-016 |











Supus modificărilor.

| | | |
|--|--|--|
|  | Nr. articol: 769-513 Center module for 1-conductor female connector; angled; 4 mm ² ; 1-pole; 4,00 mm ² ; gray | www.wago.com/769-513 |
|  | Nr. articol: 769-513/000-006 Center module for 1-conductor female connector; angled; 4 mm ² ; 1-pole; 4,00 mm ² ; blue | www.wago.com/769-513/000-006 |
|  | Nr. articol: 769-513/000-016 Center module for 1-conductor female connector; angled; 4 mm ² ; 1-pole; 4,00 mm ² ; green-yellow | www.wago.com/769-513/000-016 |
|  | Nr. articol: 769-515 End module for 1-conductor female connector; angled; 4 mm ² ; 1-pole; 4,00 mm ² ; gray | www.wago.com/769-515 |
|  | Nr. articol: 769-515/000-006 End module for 1-conductor female connector; angled; 4 mm ² ; 1-pole; 4,00 mm ² ; blue | www.wago.com/769-515/000-006 |
|  | Nr. articol: 769-515/000-016 End module for 1-conductor female connector; angled; 4 mm ² ; 1-pole; 4,00 mm ² ; green-yellow | www.wago.com/769-515/000-016 |
|  | Nr. articol: 786-101 Empty component plug housing; Type 14; 15 mm wide; 6-pole; gray | www.wago.com/786-101 |
|  | Nr. articol: 786-103 Empty component plug housing; Type 16; 25 mm wide; 10-pole; gray | www.wago.com/786-103 |
| Marking accessories | | |
|  | Nr. articol: 2009-145 Mini-WSB Inline; for Smart Printer; 1700 pieces on roll; stretchable 5 - 5.2 mm; plain; snap-on type; white | www.wago.com/2009-145 |
|  | Nr. articol: 2009-145/000-002 Mini-WSB Inline; for Smart Printer; 1700 pieces on roll; stretchable 5 - 5.2 mm; plain; snap-on type; yellow | www.wago.com/2009-145/000-002 |
|  | Nr. articol: 2009-145/000-005 Mini-WSB Inline; for Smart Printer; 1700 pieces on roll; stretchable 5 - 5.2 mm; plain; snap-on type; red | www.wago.com/2009-145/000-005 |
|  | Nr. articol: 2009-145/000-006 Mini-WSB Inline; for Smart Printer; 1700 pieces on roll; stretchable 5 - 5.2 mm; plain; snap-on type; blue | www.wago.com/2009-145/000-006 |
|  | Nr. articol: 2009-145/000-007 Mini-WSB Inline; for Smart Printer; 1700 pieces on roll; stretchable 5 - 5.2 mm; plain; snap-on type; gray | www.wago.com/2009-145/000-007 |
|  | Nr. articol: 2009-145/000-012 Mini-WSB Inline; for Smart Printer; 1700 pieces on roll; stretchable 5 - 5.2 mm; plain; snap-on type; orange | www.wago.com/2009-145/000-012 |
| | Nr. articol: 2009-145/000-023 | |

Supus modificărilor.

| | | |
|--|--|--|
|  | Mini-WSB Inline; for Smart Printer; 1700 pieces on roll; stretchable 5 - 5.2 mm; plain; snap-on type; green | www.wago.com/2009-145/000-023 |
|  | Nr. articol: 2009-145/000-024 Mini-WSB Inline; for Smart Printer; 1700 pieces on roll; stretchable 5 - 5.2 mm; plain; snap-on type; violet | www.wago.com/2009-145/000-024 |
|  | Nr. articol: 248-501 Miniature WSB Quick marking system; plain; Marker width 5 mm; 10 strips with 10 markers per card | www.wago.com/248-501 |
|  | Nr. articol: 248-501/000-002 Mini-WSB marking card; as card; not stretchable; plain; snap-on type; yellow | www.wago.com/248-501/000-002 |
|  | Nr. articol: 248-501/000-005 Mini-WSB marking card; as card; not stretchable; plain; snap-on type; red | www.wago.com/248-501/000-005 |
|  | Nr. articol: 248-501/000-006 Mini-WSB marking card; as card; not stretchable; plain; snap-on type; blue | www.wago.com/248-501/000-006 |
|  | Nr. articol: 248-501/000-007 Mini-WSB marking card; as card; not stretchable; plain; snap-on type; gray | www.wago.com/248-501/000-007 |
|  | Nr. articol: 248-501/000-012 Mini-WSB marking card; as card; not stretchable; plain; snap-on type; orange | www.wago.com/248-501/000-012 |
|  | Nr. articol: 248-501/000-017 Mini-WSB marking card; as card; not stretchable; plain; snap-on type; light green | www.wago.com/248-501/000-017 |
|  | Nr. articol: 248-501/000-023 Mini-WSB marking card; as card; not stretchable; plain; snap-on type; green | www.wago.com/248-501/000-023 |
|  | Nr. articol: 248-501/000-024 Mini-WSB marking card; as card; not stretchable; plain; snap-on type; violet | www.wago.com/248-501/000-024 |
| plug | | |
|  | Nr. articol: 281-511 Fuse plug; with pull-tab; for miniature metric fuses 5 x 20 mm and 5 x 25 mm; without blown fuse indication; 6 mm wide; gray | www.wago.com/281-511 |
|  | Nr. articol: 281-512 Fuse plug; with pull-tab; for miniature metric fuses 5 x 20 mm and 5 x 25 mm; with port for LED; 6 mm wide; gray | www.wago.com/281-512 |
|  | Nr. articol: 281-512/281-417 Fuse plug; with pull-tab; for miniature metric fuses 5 x 20 mm and 5 x 25 mm; with blown fuse indication by neon lamp; 230 V; 6 mm wide; gray | www.wago.com/281-512/281-417 |















Supus modificărilor.

| | | |
|--|--|--|
|  | Nr. articol: 281-512/281-418 Fuse plug; with pull-tab; for miniature metric fuses 5 x 20 mm and 5 x 25 mm; with blown fuse indication by neon lamp; 120 V; 6 mm wide; gray | www.wago.com/281-512/281-418 |
|  | Nr. articol: 281-512/281-501 Fuse plug; with pull-tab; for miniature metric fuses 5 x 20 mm and 5 x 25 mm; with LED indicator; 24 V AC/DC; 6 mm wide; gray | www.wago.com/281-512/281-501 |
| tools | | |
|  | Nr. articol: 210-720 Operating tool; Blade: 3.5 x 0.5 mm; with a partially insulated shaft | www.wago.com/210-720 |
| End plate | | |
|  | Nr. articol: 769-309 End and intermediate plate; 1.1 mm thick; gray | www.wago.com/769-309 |
|  | Nr. articol: 769-310 End and intermediate plate; 1.1 mm thick; orange | www.wago.com/769-310 |
|  | Nr. articol: 769-311 End and intermediate plate; 1.1 mm thick; gray | www.wago.com/769-311 |
|  | Nr. articol: 769-312 End and intermediate plate; 1.1 mm thick; orange | www.wago.com/769-312 |
|  | Nr. articol: 769-313 Separator plate; 1.1 mm thick; oversized; orange | www.wago.com/769-313 |
|  | Nr. articol: 769-314 Separator plate; 1.1 mm thick; oversized; orange | www.wago.com/769-314 |
| Carrier rail | | |
|  | Nr. articol: 210-112 Steel carrier rail; 35 x 7.5 mm; 1 mm thick; 2 m long; slotted; according to EN 60715; "Hole width 25 mm | www.wago.com/210-112 |
| | Nr. articol: 210-113 Steel carrier rail; 35 x 7.5 mm; 1 mm thick; 2 m long; unslotted; according to EN 60715 | www.wago.com/210-113 |
| | Nr. articol: 210-114 Steel carrier rail; 35 x 15 mm; 1.5 mm thick; 2 m long; unslotted; similar to EN 60715 | www.wago.com/210-114 |
| | Nr. articol: 210-115 Steel carrier rail; 35 x 7.5 mm; 1 mm thick; 2 m long; slotted; according to EN 60715; "Hole width 18 mm | www.wago.com/210-115 |
|  | Nr. articol: 210-118 Steel carrier rail; 35 x 15 mm; 2.3 mm thick; 2 m long; unslotted; according to EN 60715 | www.wago.com/210-118 |
| | Nr. articol: 210-196 Aluminum carrier rail; 35 x 8.2 mm; 1.6 mm thick; 2 m long; unslotted; similar to EN 60715; silver-colored | www.wago.com/210-196 |

Supus modificărilor.

WAGO Kontakttechnik GmbH & Co. KG
/Representative Office Romania
Sos. Pipera-Tunari nr. 1/1
building 1, 2nd floor | 077190 Voluntari, Ilfov
Tel.: +40-(0)31 421 85 68 | Email: info-RO@wago.com















Aveți întrebări despre produsele noastre?
Vă stăm la dispoziție pentru preluarea apelului la +40 (0) 31 421 85 68.

| | | |
|--|--|--|
|  | Nr. articol: 210-197 Steel carrier rail; 35 x 15 mm; 1.5 mm thick; 2 m long; slotted; similar to EN 60715 | www.wago.com/210-197 |
|  | Nr. articol: 210-198 Copper carrier rail; 35 x 15 mm; 2.3 mm thick; 2 m long; unslotted; according to EN 60715; copper-colored | www.wago.com/210-198 |
|  | Nr. articol: 210-504 Steel carrier rail; 35 x 7.5 mm; 1 mm thick; 2 m long; slotted; galvanized; according to EN 60715 | www.wago.com/210-504 |
|  | Nr. articol: 210-505 Steel carrier rail; 35 x 7.5 mm; 1 mm thick; 2 m long; unslotted; galvanized; according to EN 60715 | www.wago.com/210-505 |
|  | Nr. articol: 210-506 Steel carrier rail; 35 x 15 mm; 1.5 mm thick; 2 m long; unslotted; galvanized; similar to EN 60715 | www.wago.com/210-506 |
|  | Nr. articol: 210-508 Steel carrier rail; 35 x 15 mm; 1.5 mm thick; 2 m long; slotted; galvanized; similar to EN 60715 | www.wago.com/210-508 |
| Female plug | | |
|  | Nr. articol: 769-101 1-conductor female plug; 4 mm ² ; 1-pole; 4,00 mm ² ; gray | www.wago.com/769-101 |
|  | Nr. articol: 769-101/000-006 1-conductor female plug; 4 mm ² ; 1-pole; 4,00 mm ² ; blue | www.wago.com/769-101/000-006 |
|  | Nr. articol: 769-101/000-016 1-conductor female plug; 4 mm ² ; 1-pole; 4,00 mm ² ; green-yellow | www.wago.com/769-101/000-016 |
|  | Nr. articol: 769-101/022-000 1-conductor female plug; angled; 4 mm ² ; 1-pole; 4,00 mm ² ; gray | www.wago.com/769-101/022-000 |
|  | Nr. articol: 769-101/022-016 1-conductor female plug; angled; 4 mm ² ; 1-pole; 4,00 mm ² ; green-yellow | www.wago.com/769-101/022-016 |
|  | Nr. articol: 769-102 1-conductor female plug; 4 mm ² ; 2-pole; 4,00 mm ² ; gray | www.wago.com/769-102 |
|  | Nr. articol: 769-102/000-006 1-conductor female plug; 4 mm ² ; 2-pole; 4,00 mm ² ; blue | www.wago.com/769-102/000-006 |
|  | Nr. articol: 769-102/000-036 1-conductor female plug; 4 mm ² ; 2-pole; 4,00 mm ² ; gray, green-yellow | www.wago.com/769-102/000-036 |
|  | Nr. articol: 769-102/000-037 1-conductor female plug; 4 mm ² ; 2-pole; 4,00 mm ² ; green-yellow, gray | www.wago.com/769-102/000-037 |















Supus modificărilor.

WAGO Kontakttechnik GmbH & Co. KG
/Representative Office Romania
Sos. Pipera-Tunari nr. 1/1
building 1, 2nd floor | 077190 Voluntari, Ilfov
Tel.: +40-(0)31 421 85 68 | Email: info-RO@wago.com

Aveți întrebări despre produsele noastre?
Vă stăm la dispoziție pentru preluarea apelului la +40 (0) 31 421 85 68.

| | | |
|--|---|--|
|  | Nr. articol: 769-102/022-000 1-conductor female plug; angled; 4 mm²; 2-pole; 4,00 mm²; gray | www.wago.com/769-102/022-000 |
|  | Nr. articol: 769-103 1-conductor female plug; 4 mm²; 3-pole; 4,00 mm²; gray | www.wago.com/769-103 |
|  | Nr. articol: 769-103/000-006 1-conductor female plug; 4 mm²; 3-pole; 4,00 mm²; blue | www.wago.com/769-103/000-006 |
|  | Nr. articol: 769-103/000-036 1-conductor female plug; 4 mm²; 3-pole; 4,00 mm²; gray, green-yellow | www.wago.com/769-103/000-036 |
|  | Nr. articol: 769-103/000-037 1-conductor female plug; 4 mm²; 3-pole; 4,00 mm²; green-yellow, gray | www.wago.com/769-103/000-037 |
|  | Nr. articol: 769-103/000-038 1-conductor female plug; 4 mm²; 3-pole; 4,00 mm²; gray, blue, green-yellow | www.wago.com/769-103/000-038 |
|  | Nr. articol: 769-103/000-039 1-conductor female plug; 4 mm²; 3-pole; 4,00 mm²; green-yellow, blue, gray | www.wago.com/769-103/000-039 |
|  | Nr. articol: 769-103/022-000 1-conductor female plug; angled; 4 mm²; 3-pole; 4,00 mm²; gray | www.wago.com/769-103/022-000 |
|  | Nr. articol: 769-104 1-conductor female plug; 4 mm²; 4-pole; 4,00 mm²; gray | www.wago.com/769-104 |
|  | Nr. articol: 769-104/000-006 1-conductor female plug; 4 mm²; 4-pole; 4,00 mm²; blue | www.wago.com/769-104/000-006 |
|  | Nr. articol: 769-104/000-036 1-conductor female plug; 4 mm²; 4-pole; 4,00 mm²; gray, green-yellow | www.wago.com/769-104/000-036 |
|  | Nr. articol: 769-104/000-037 1-conductor female plug; 4 mm²; 4-pole; 4,00 mm²; green-yellow, gray | www.wago.com/769-104/000-037 |
|  | Nr. articol: 769-104/000-038 1-conductor female plug; 4 mm²; 4-pole; 4,00 mm²; gray, blue, green-yellow | www.wago.com/769-104/000-038 |
|  | Nr. articol: 769-104/000-039 1-conductor female plug; 4 mm²; 4-pole; 4,00 mm²; green-yellow, blue, gray | www.wago.com/769-104/000-039 |

Supus modificărilor.

| | | |
|--|---|--|
|  | Nr. articol: 769-104/022-000 1-conductor female plug; angled; 4 mm²; 4-pole; 4,00 mm²; gray | www.wago.com/769-104/022-000 |
|  | Nr. articol: 769-105 1-conductor female plug; 4 mm²; 5-pole; 4,00 mm²; gray | www.wago.com/769-105 |
|  | Nr. articol: 769-105/000-006 1-conductor female plug; 4 mm²; 5-pole; 4,00 mm²; blue | www.wago.com/769-105/000-006 |
|  | Nr. articol: 769-105/000-036 1-conductor female plug; 4 mm²; 5-pole; 4,00 mm²; gray, green-yellow | www.wago.com/769-105/000-036 |
|  | Nr. articol: 769-105/000-037 1-conductor female plug; 4 mm²; 5-pole; 4,00 mm²; green-yellow, gray | www.wago.com/769-105/000-037 |
|  | Nr. articol: 769-105/000-038 1-conductor female plug; 4 mm²; 5-pole; 4,00 mm²; gray, blue, green-yellow | www.wago.com/769-105/000-038 |
|  | Nr. articol: 769-105/000-039 1-conductor female plug; 4 mm²; 5-pole; 4,00 mm²; green-yellow, blue, gray | www.wago.com/769-105/000-039 |
|  | Nr. articol: 769-105/022-000 1-conductor female plug; angled; 4 mm²; 5-pole; 4,00 mm²; gray | www.wago.com/769-105/022-000 |
|  | Nr. articol: 769-106 1-conductor female plug; 4 mm²; 6-pole; 4,00 mm²; gray | www.wago.com/769-106 |
|  | Nr. articol: 769-106/000-006 1-conductor female plug; 4 mm²; 6-pole; 4,00 mm²; blue | www.wago.com/769-106/000-006 |
|  | Nr. articol: 769-106/000-036 1-conductor female plug; 4 mm²; 6-pole; 4,00 mm²; gray, green-yellow | www.wago.com/769-106/000-036 |
|  | Nr. articol: 769-106/000-037 1-conductor female plug; 4 mm²; 6-pole; 4,00 mm²; green-yellow, gray | www.wago.com/769-106/000-037 |
|  | Nr. articol: 769-106/000-038 1-conductor female plug; 4 mm²; 6-pole; 4,00 mm²; gray, blue, green-yellow | www.wago.com/769-106/000-038 |
|  | Nr. articol: 769-106/000-039 1-conductor female plug; 4 mm²; 6-pole; 4,00 mm²; green-yellow, blue, gray | www.wago.com/769-106/000-039 |

Supus modificărilor.



Nr. articol: 769-106/022-000
1-conductor female plug; angled; 4 mm²; 6-pole; 4,00 mm²; gray

www.wago.com/769-106/022-000



Nr. articol: 769-107
1-conductor female plug; 4 mm²; 7-pole; 4,00 mm²; gray

www.wago.com/769-107



Nr. articol: 769-107/000-006
1-conductor female plug; 4 mm²; 7-pole; 4,00 mm²; blue

www.wago.com/769-107/000-006



Nr. articol: 769-107/000-036
1-conductor female plug; 4 mm²; 7-pole; 4,00 mm²; gray, green-yellow

www.wago.com/769-107/000-036



Nr. articol: 769-107/000-037
1-conductor female plug; 4 mm²; 7-pole; 4,00 mm²; green-yellow, gray

www.wago.com/769-107/000-037



Nr. articol: 769-107/000-038
1-conductor female plug; 4 mm²; 7-pole; 4,00 mm²; gray, blue, green-yellow

www.wago.com/769-107/000-038



Nr. articol: 769-107/000-039
1-conductor female plug; 4 mm²; 7-pole; 4,00 mm²; green-yellow, blue, gray

www.wago.com/769-107/000-039



Nr. articol: 769-107/022-000
1-conductor female plug; angled; 4 mm²; 7-pole; 4,00 mm²; gray

www.wago.com/769-107/022-000



Nr. articol: 769-108
1-conductor female plug; 4 mm²; 8-pole; 4,00 mm²; gray

www.wago.com/769-108



Nr. articol: 769-108/000-006
1-conductor female plug; 4 mm²; 8-pole; 4,00 mm²; blue

www.wago.com/769-108/000-006



Nr. articol: 769-108/000-036
1-conductor female plug; 4 mm²; 8-pole; 4,00 mm²; gray, green-yellow

www.wago.com/769-108/000-036



Nr. articol: 769-108/000-037
1-conductor female plug; 4 mm²; 8-pole; 4,00 mm²; green-yellow, gray

www.wago.com/769-108/000-037



Nr. articol: 769-108/000-038
1-conductor female plug; 4 mm²; 8-pole; 4,00 mm²; gray, blue, green-yellow

www.wago.com/769-108/000-038

















Nr. articol: 769-108/000-039
1-conductor female plug; 4 mm²; 8-pole; 4,00 mm²; green-yellow, blue, gray

www.wago.com/769-108/000-039

Supus modificărilor.

WAGO Kontakttechnik GmbH & Co. KG
/Representative Office Romania
Sos. Pipera-Tunari nr. 1/1
building 1, 2nd floor | 077190 Voluntari, Ilfov
Tel.: +40-(0)31 421 85 68 | Email: info-RO@wago.com

Aveți întrebări despre produsele noastre?
Vă stăm la dispoziție pentru preluarea apelului la +40 (0) 31 421 85 68.

| | | |
|--|--|--|
|  | Nr. articol: 769-108/022-000 1-conductor female plug; angled; 4 mm²; 8-pole; 4,00 mm²; gray | www.wago.com/769-108/022-000 |
|  | Nr. articol: 769-109 1-conductor female plug; 4 mm²; 9-pole; 4,00 mm²; gray | www.wago.com/769-109 |
|  | Nr. articol: 769-109/000-006 1-conductor female plug; 4 mm²; 9-pole; 4,00 mm²; blue | www.wago.com/769-109/000-006 |
|  | Nr. articol: 769-109/000-036 1-conductor female plug; 4 mm²; 9-pole; 4,00 mm²; gray, green-yellow | www.wago.com/769-109/000-036 |
|  | Nr. articol: 769-109/000-037 1-conductor female plug; 4 mm²; 9-pole; 4,00 mm²; green-yellow, gray | www.wago.com/769-109/000-037 |
|  | Nr. articol: 769-109/000-038 1-conductor female plug; 4 mm²; 9-pole; 4,00 mm²; gray, blue, green-yellow | www.wago.com/769-109/000-038 |
|  | Nr. articol: 769-109/000-039 1-conductor female plug; 4 mm²; 9-pole; 4,00 mm²; green-yellow, blue, gray | www.wago.com/769-109/000-039 |
|  | Nr. articol: 769-109/022-000 1-conductor female plug; angled; 4 mm²; 9-pole; 4,00 mm²; gray | www.wago.com/769-109/022-000 |
|  | Nr. articol: 769-110 1-conductor female plug; 4 mm²; 10-pole; 4,00 mm²; gray | www.wago.com/769-110 |
|  | Nr. articol: 769-110/000-006 1-conductor female plug; 4 mm²; 10-pole; 4,00 mm²; blue | www.wago.com/769-110/000-006 |
|  | Nr. articol: 769-110/000-036 1-conductor female plug; 4 mm²; 10-pole; 4,00 mm²; gray, green-yellow | www.wago.com/769-110/000-036 |
|  | Nr. articol: 769-110/000-037 1-conductor female plug; 4 mm²; 10-pole; 4,00 mm²; green-yellow, gray | www.wago.com/769-110/000-037 |
|  | Nr. articol: 769-110/000-038 1-conductor female plug; 4 mm²; 10-pole; 4,00 mm²; gray, blue, green-yellow | www.wago.com/769-110/000-038 |
|  | Nr. articol: 769-110/000-039 1-conductor female plug; 4 mm²; 10-pole; 4,00 mm²; green-yellow, blue, gray | www.wago.com/769-110/000-039 |

Supus modificărilor.

WAGO Kontakttechnik GmbH & Co. KG
/Representative Office Romania
Sos. Pipera-Tunari nr. 1/1
building 1, 2nd floor | 077190 Voluntari, Ilfov
Tel.: +40-(0)31 421 85 68 | Email: info-RO@wago.com

Aveți întrebări despre produsele noastre?
Vă stăm la dispoziție pentru preluarea apelului la +40 (0) 31 421 85 68.



Nr. articol: 769-110/022-000
1-conductor female plug; angled; 4 mm²; 10-pole; 4,00 mm²; gray

www.wago.com/769-110/022-000



Nr. articol: 769-111
1-conductor female plug; 4 mm²; 11-pole; 4,00 mm²; gray

www.wago.com/769-111



Nr. articol: 769-111/000-006
1-conductor female plug; 4 mm²; 11-pole; 4,00 mm²; blue

www.wago.com/769-111/000-006



Nr. articol: 769-111/000-036
1-conductor female plug; 4 mm²; 11-pole; 4,00 mm²; gray, green-yellow

www.wago.com/769-111/000-036



Nr. articol: 769-111/000-037
1-conductor female plug; 4 mm²; 11-pole; 4,00 mm²; green-yellow, gray

www.wago.com/769-111/000-037



Nr. articol: 769-111/000-038
1-conductor female plug; 4 mm²; 11-pole; 4,00 mm²; gray, blue, green-yellow

www.wago.com/769-111/000-038



Nr. articol: 769-111/000-039
1-conductor female plug; 4 mm²; 11-pole; 4,00 mm²; green-yellow, blue, gray

www.wago.com/769-111/000-039



Nr. articol: 769-111/022-000
1-conductor female plug; angled; 4 mm²; 11-pole; 4,00 mm²; gray

www.wago.com/769-111/022-000



Nr. articol: 769-112
1-conductor female plug; 4 mm²; 12-pole; 4,00 mm²; gray

www.wago.com/769-112



Nr. articol: 769-112/000-006
1-conductor female plug; 4 mm²; 12-pole; 4,00 mm²; blue

www.wago.com/769-112/000-006



Nr. articol: 769-112/000-036
1-conductor female plug; 4 mm²; 12-pole; 4,00 mm²; gray, green-yellow

www.wago.com/769-112/000-036



Nr. articol: 769-112/000-037
1-conductor female plug; 4 mm²; 12-pole; 4,00 mm²; green-yellow, gray

www.wago.com/769-112/000-037



Nr. articol: 769-112/000-038
1-conductor female plug; 4 mm²; 12-pole; 4,00 mm²; gray, blue, green-yellow

www.wago.com/769-112/000-038



Nr. articol: 769-112/000-039
1-conductor female plug; 4 mm²; 12-pole; 4,00 mm²; green-yellow, blue, gray

www.wago.com/769-112/000-039

Supus modificărilor.



Nr. articol: 769-112/022-000
1-conductor female plug; angled; 4 mm²; 12-pole; 4,00 mm²; gray

www.wago.com/769-112/022-000



Nr. articol: 769-113
1-conductor female plug; 4 mm²; 13-pole; 4,00 mm²; gray

www.wago.com/769-113



Nr. articol: 769-113/000-036
1-conductor female plug; 4 mm²; 13-pole; 4,00 mm²; gray, green-yellow

www.wago.com/769-113/000-036



Nr. articol: 769-113/000-037
1-conductor female plug; 4 mm²; 13-pole; 4,00 mm²; green-yellow, gray

www.wago.com/769-113/000-037



Nr. articol: 769-113/000-038
1-conductor female plug; 4 mm²; 13-pole; 4,00 mm²; gray, blue, green-yellow

www.wago.com/769-113/000-038



Nr. articol: 769-113/000-039
1-conductor female plug; 4 mm²; 13-pole; 4,00 mm²; green-yellow, blue, gray

www.wago.com/769-113/000-039



Nr. articol: 769-113/022-000
1-conductor female plug; angled; 4 mm²; 13-pole; 4,00 mm²; gray

www.wago.com/769-113/022-000



Nr. articol: 769-114
1-conductor female plug; 4 mm²; 14-pole; 4,00 mm²; gray

www.wago.com/769-114



Nr. articol: 769-114/000-006
1-conductor female plug; 4 mm²; 14-pole; 4,00 mm²; blue

www.wago.com/769-114/000-006



Nr. articol: 769-114/000-036
1-conductor female plug; 4 mm²; 14-pole; 4,00 mm²; gray, green-yellow

www.wago.com/769-114/000-036



Nr. articol: 769-114/000-037
1-conductor female plug; 4 mm²; 14-pole; 4,00 mm²; green-yellow, gray

www.wago.com/769-114/000-037



Nr. articol: 769-114/000-038
1-conductor female plug; 4 mm²; 14-pole; 4,00 mm²; gray, blue, green-yellow

www.wago.com/769-114/000-038



Nr. articol: 769-114/000-039
1-conductor female plug; 4 mm²; 14-pole; 4,00 mm²; green-yellow, blue, gray

www.wago.com/769-114/000-039



Nr. articol: 769-114/022-000
1-conductor female plug; angled; 4 mm²; 14-pole; 4,00 mm²; gray

www.wago.com/769-114/022-000

Supus modificărilor.



Nr. articol: 769-115
1-conductor female plug; 4 mm²; 15-pole; 4,00 mm²; gray

www.wago.com/769-115



Nr. articol: 769-115/000-036
1-conductor female plug; 4 mm²; 15-pole; 4,00 mm²; gray, green-yellow

www.wago.com/769-115/000-036



Nr. articol: 769-115/000-037
1-conductor female plug; 4 mm²; 15-pole; 4,00 mm²; green-yellow, gray

www.wago.com/769-115/000-037



Nr. articol: 769-115/000-038
1-conductor female plug; 4 mm²; 15-pole; 4,00 mm²; gray, blue, green-yellow

www.wago.com/769-115/000-038



Nr. articol: 769-115/000-039
1-conductor female plug; 4 mm²; 15-pole; 4,00 mm²; green-yellow, blue, gray

www.wago.com/769-115/000-039



Nr. articol: 769-115/022-000
1-conductor female plug; angled; 4 mm²; 15-pole; 4,00 mm²; gray

www.wago.com/769-115/022-000

ferrule



Nr. articol: 216-101
Ferrule; Sleeve for 0.5 mm² / AWG 22; uninsulated; electro-tin plated

www.wago.com/216-101



Nr. articol: 216-102
Ferrule; Sleeve for 0.75 mm² / AWG 20; uninsulated; electro-tin plated

www.wago.com/216-102



Nr. articol: 216-103
Ferrule; Sleeve for 1 mm² / AWG 18; uninsulated; electro-tin plated

www.wago.com/216-103



Nr. articol: 216-104
Ferrule; Sleeve for 1.5 mm² / AWG 16; uninsulated; electro-tin plated

www.wago.com/216-104



Nr. articol: 216-201
Ferrule; Sleeve for 0.5 mm² / 20 AWG; insulated; electro-tin plated; white

www.wago.com/216-201



Nr. articol: 216-202
Ferrule; Sleeve for 0.75 mm² / 18 AWG; insulated; electro-tin plated; gray

www.wago.com/216-202



Nr. articol: 216-203
Ferrule; Sleeve for 1 mm² / AWG 18; insulated; electro-tin plated; red

www.wago.com/216-203



Nr. articol: 216-204
Ferrule; Sleeve for 1.5 mm² / AWG 16; insulated; electro-tin plated; black

www.wago.com/216-204



















Nr. articol: 216-206
Ferrule; Sleeve for 2.5 mm² / AWG 14; insulated; electro-tin plated; blue

www.wago.com/216-206

Nr. articol: 216-301
Ferrule; Sleeve for 0.25 mm² / AWG 24; insulated; electro-tin plated; yellow

www.wago.com/216-301

Supus modificărilor.

| | | |
|--|--|--|
|  | Nr. articol: 216-302 Ferrule; Sleeve for 0.34 mm ² / 22 AWG; insulated; electro-tin plated; green | www.wago.com/216-302 |
| Coding | | |
| | Nr. articol: 769-435 Coding pin; for coding of female plugs; for carrier terminal blocks / male connectors; orange | www.wago.com/769-435 |
| Insulation stop | | |
|  | Nr. articol: 769-470 Insulation stop; 0.08 - 0.2 mm ² "s" (0.14 mm ² "f-st"); 5 pieces/strip; white | www.wago.com/769-470 |
|  | Nr. articol: 769-471 Insulation stop; 0.25 - 0.5 mm ² ; 5 pieces/strip; light gray | www.wago.com/769-471 |
|  | Nr. articol: 769-472 Insulation stop; 0.75 - 1 mm ² ; 5 pieces/strip; dark gray | www.wago.com/769-472 |
| Jumper | | |
|  | Nr. articol: 249-123 Push-in type wire jumper; insulated; wire length 180 mm; Conductor cross section 0.75 mm ² | www.wago.com/249-123 |
|  | Nr. articol: 249-125 Push-in type wire jumper; insulated; wire length 60 mm; Conductor cross section 0.75 mm ² | www.wago.com/249-125 |
|  | Nr. articol: 249-126 Push-in type wire jumper; insulated; wire length 110 mm; Conductor cross section 0.75 mm ² | www.wago.com/249-126 |
|  | Nr. articol: 249-127 Push-in type wire jumper; insulated; wire length 250 mm; Conductor cross section 0.75 mm ² | www.wago.com/249-127 |
|  | Nr. articol: 280-402 Adjacent jumper; insulated; IN = IN terminal block; gray | www.wago.com/280-402 |
|  | Nr. articol: 280-409 Alternate jumper; insulated; IN = IN terminal block; gray | www.wago.com/280-409 |
|  | Nr. articol: 780-452 Staggered jumper; insulated; from 1 to 2; Spacing: 5 mm; suitable for 2-conductor female plugs; gray | www.wago.com/780-452 |
|  | Nr. articol: 780-453 Staggered jumper; insulated; from 1 to 3; Spacing: 5 mm; suitable for 2-conductor female plugs; gray | www.wago.com/780-453 |
|  | Nr. articol: 780-454 Staggered jumper; insulated; from 1 to 4; Spacing: 5 mm; suitable for 2-conductor female plugs; gray | www.wago.com/780-454 |
|  | Nr. articol: 780-455 Staggered jumper; insulated; from 1 to 5; Spacing: 5 mm; suitable for 2-conductor female plugs; gray | www.wago.com/780-455 |
|  | Nr. articol: 780-456 Staggered jumper; insulated; from 1 to 6; Spacing: 5 mm; suitable for 2-conductor female plugs; gray | www.wago.com/780-456 |
|  | Nr. articol: 780-457 Staggered jumper; insulated; from 1 to 7; Spacing: 5 mm; suitable for 2-conductor female plugs; gray | www.wago.com/780-457 |

Supus modificărilor.

WAGO Kontakttechnik GmbH & Co. KG
/Representative Office Romania
Sos. Pipera-Tunari nr. 1/1
building 1, 2nd floor | 077190 Voluntari, Ilfov
Tel.: +40-(0)31 421 85 68 | Email: info-RO@wago.com

Aveți întrebări despre produsele noastre?
Vă stăm la dispoziție pentru preluarea apelului la +40 (0) 31 421 85 68.



Nr. articol: 780-458

Staggered jumper; insulated; from 1 to 8; Spacing: 5 mm; suitable for 2-conductor female plugs; gray

www.wago.com/780-458

Descărcări Documentation

Additional Information

Technical explanations

Apr 3, 2019

pdf
2,1 MB

Descărcare

CAD/CAE-Data

CAD data

2D/3D Models 769-183/769-314

URL

Descărcare

CAE data

EPLAN Data Portal 769-183/769-314

URL

Descărcare

WSCAD Universe 769-183/769-314

URL

Descărcare

Installation Notes

Installation

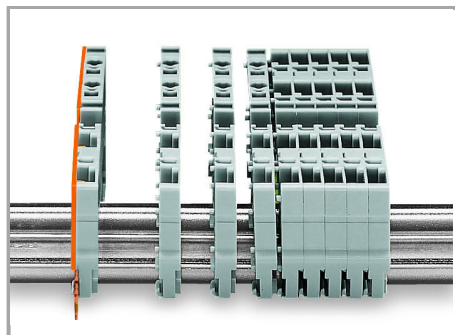

Snap individual carrier terminal blocks onto the carrier rail and slide together.

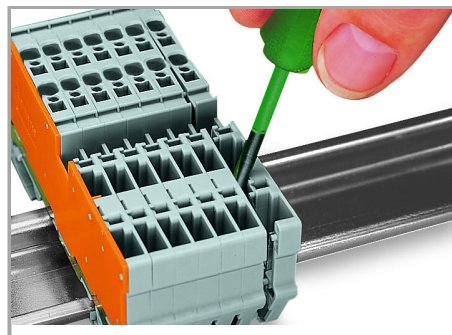

Open the assembly by laterally sliding a block via operating tool and remove terminal block via release lever.

Conductor termination

Supus modificărilor.

WAGO Kontakttechnik GmbH & Co. KG
/Representative Office Romania
Sos. Pipera-Tunari nr. 1/1
building 1, 2nd floor | 077190 Voluntari, Ilfov
Tel.: +40-(0)31 421 85 68 | Email: info-RO@wago.com

Aveți întrebări despre produsele noastre?
Vă stăm la dispoziție pentru preluarea apelului la +40 (0) 31 421 85 68.

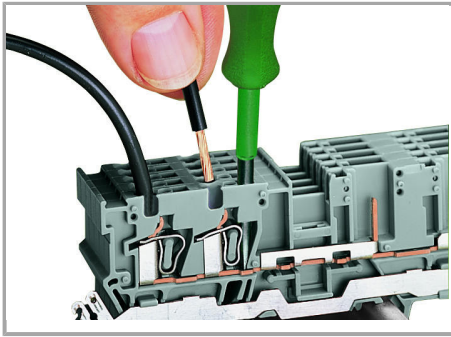

CAGE CLAMP® connection

Carrier terminal block: Insert/remove conductor via operating tool (3.5 x 0.5 mm blade).

Commoning

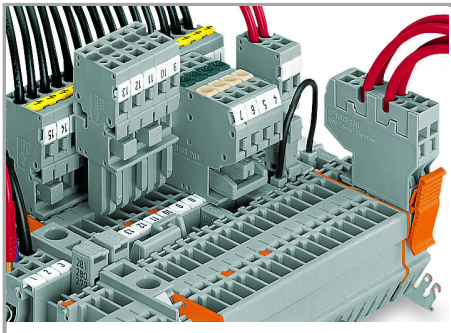

Commoning with adjacent or staggered jumpers –

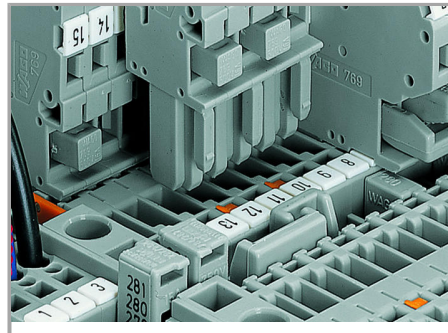

Commoning carrier terminal blocks via staggered jumpers.

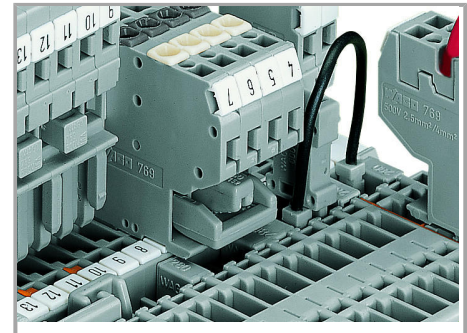

Commoning a 2-conductor female plug via staggered jumper and carrier terminal blocks via adjacent jumpers.

push jumpers down until fully inserted.

Supus modificărilor.

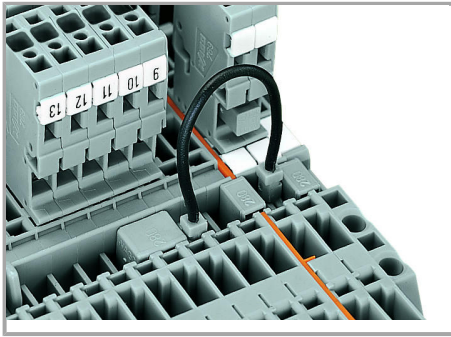

Commoning carrier terminal blocks via push-in type wire jumpers or adjacent jumpers – even over an intermediate plate.

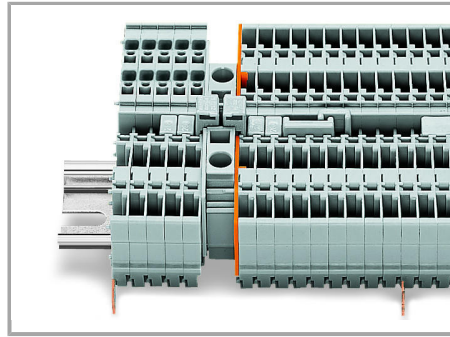

Commoning “supply terminal blocks” (up to 10 mm²/8 AWG) with carrier terminal blocks via step-down jumpers.

Testing

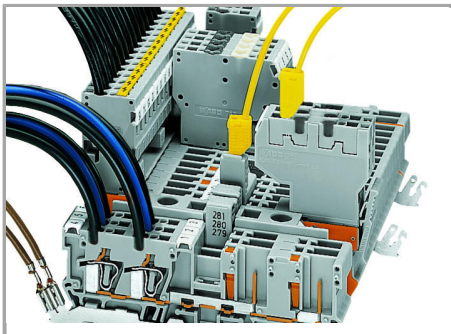

Testing via 2 or 2.3 mm Ø test plugs.

Coding

Supus modificărilor.

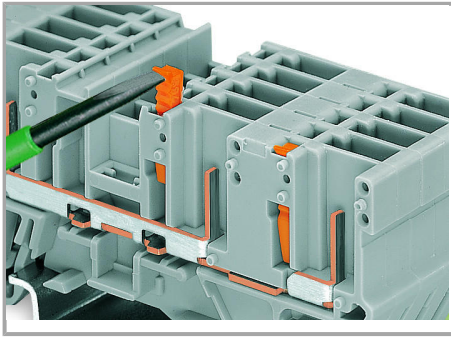

Snap coding pin in proper direction on carrier terminal block.

Shown: Coding pin removal from carrier terminal block.

Locking lever

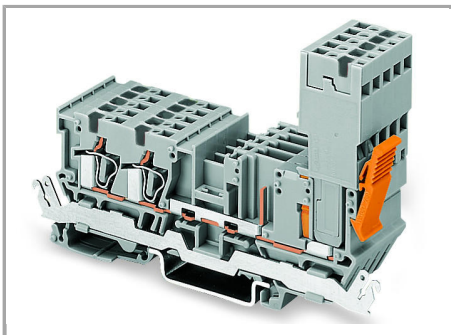

Female plug secured with locking lever on the terminal block side.

Supus modificărilor.

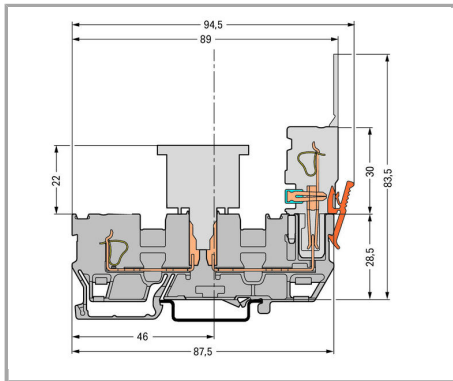

Carrier terminal block

Familie de produse

X-COM

Afișare globală produse din familie.

Supus modificărilor.