

Fișă tehnică | Număr articol: 769-162/769-313

2-pin terminal block for pluggable modules; 4-pole; with 2 jumper positions; with orange separator plate; for DIN-rail 35 x 15 and 35 x 7.5; 4,00 mm²; gray

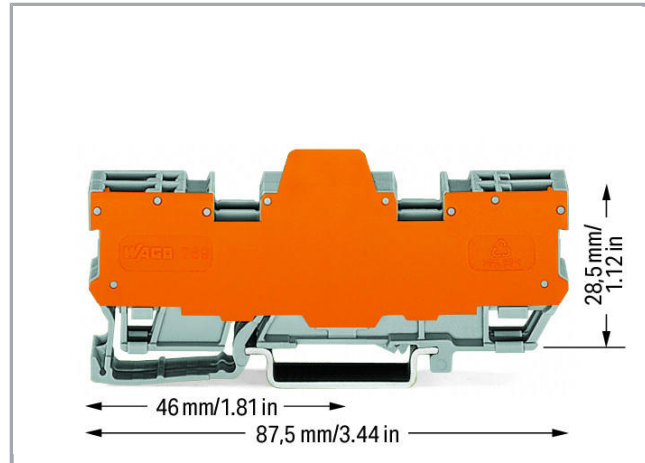

www.wago.com/769-162/769-313

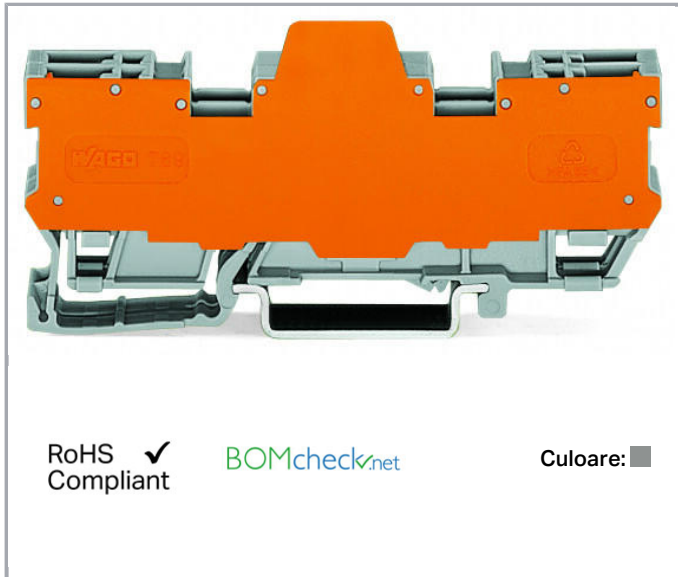

Descriere articol

Safety information 1:

2-conductor female plugs cannot be used.

Date

Electrical data

Ratings per IEC/EN 60664-1

Nominal voltage (III/3)	400 V
Rated surge voltage (III/3)	6 kV
Rated current	16 A
Legend (ratings)	(III / 3) ≙ Overvoltage category III / Pollution degree 3

Connection data

Pole No.	4
Total number of potentials	4
Number of levels	1

Supus modificărilor.

WAGO Kontakttechnik GmbH & Co. KG
/Representative Office Romania
Sos. Pipera-Tunari nr. 1/1
building 1, 2nd floor | 077190 Voluntari, Ilfov
Tel.: +40-(0)31 421 85 68 | Email: info-RO@wago.com

Aveți întrebări despre produsele noastre?
Vă stăm la dispoziție pentru preluarea apelului la +40 (0) 31 421 85 68.

Wiring type	Front-entry wiring
-------------	--------------------

Geometrical Data

Width	11,1 mm / 0.437 inch
Height from upper-edge of DIN-rail	28,5 mm / 1.122 inch
Depth	87,5 mm / 3.445 inch

Mechanical data

Design	horizontal type
Mounting type	DIN-35 rail
Marking level	Center marking

Material Data



Color	gray
Insulation material	Polyamide 66 (PA 66)
Fire load	0,402 MJ
Weight	17,7 g

Commercial data

Product Group	18 (X-COM-System)
Packaging type	BOX
Country of origin	DE
GTIN	4044918630146
Customs tariff number	85369010000

Aprobări / certificate

Country specific Approvals

Embleă	Aprobare	Text de aprobare suplimentar	Nume certificat
	CCA DEKRA Certification B.V.	EN 60947	NTR NL-7626
	CSA DEKRA Certification B.V.	C22.2 No. 158	1101144
	KEMA/KEUR	EN 60947	2190419.01

Supus modificărilor.



WAGO Kontakttechnik GmbH & Co. KG
/Representative Office Romania
Sos. Pipera-Tunari nr. 1/1
building 1, 2nd floor | 077190 Voluntari, Ilfov
Tel.: +40-(0)31 421 85 68 | Email: info-RO@wago.com

Aveți întrebări despre produsele noastre?
Vă stăm la dispoziție pentru preluarea apelului la +40 (0) 31 421 85 68.



DEKRA Certification B.V.



Ship Approvals

Emblemă	Aprobare	Text de aprobare suplimentar	Nume certificat
	ABS American Bureau of Shipping	EN 60947	20- HG1941090- PDA
	DNV GL Det Norske Veritas, Germanischer Lloyd	-	TAE00001V2

UL-Approvals

Emblemă	Aprobare	Text de aprobare suplimentar	Nume certificat
	UR Underwriters Laboratories Inc.	UL 1059	20190731- E45172
	UR Underwriters Laboratories Inc.	UL 1977	20151210- E45171

Counterpart

Produse compatibile

tools

Supus modificărilor.

WAGO Kontakttechnik GmbH & Co. KG
/Representative Office Romania
Sos. Pipera-Tunari nr. 1/1
building 1, 2nd floor | 077190 Voluntari, Ilfov
Tel.: +40-(0)31 421 85 68 | Email: info-RO@wago.com

Aveți întrebări despre produsele noastre?
Vă stăm la dispoziție pentru preluarea apelului la +40 (0) 31 421 85 68.



Nr. articol: 210-720
Operating tool; Blade: 3.5 x 0.5 mm; with a partially insulated shaft

www.wago.com/210-720

Carrier rail



Nr. articol: 210-112
Steel carrier rail; 35 x 7.5 mm; 1 mm thick; 2 m long; slotted; according to EN 60715; "Hole width 25 mm" www.wago.com/210-112

Nr. articol: 210-113
Steel carrier rail; 35 x 7.5 mm; 1 mm thick; 2 m long; unslotted; according to EN 60715 www.wago.com/210-113

Nr. articol: 210-114
Steel carrier rail; 35 x 15 mm; 1.5 mm thick; 2 m long; unslotted; similar to EN 60715 www.wago.com/210-114

Nr. articol: 210-115
Steel carrier rail; 35 x 7.5 mm; 1 mm thick; 2 m long; slotted; according to EN 60715; "Hole width 18 mm" www.wago.com/210-115



Nr. articol: 210-118
Steel carrier rail; 35 x 15 mm; 2.3 mm thick; 2 m long; unslotted; according to EN 60715 www.wago.com/210-118

Nr. articol: 210-196
Aluminum carrier rail; 35 x 8.2 mm; 1.6 mm thick; 2 m long; unslotted; similar to EN 60715; silver-colored www.wago.com/210-196



Nr. articol: 210-197
Steel carrier rail; 35 x 15 mm; 1.5 mm thick; 2 m long; slotted; similar to EN 60715 www.wago.com/210-197



Nr. articol: 210-198
Copper carrier rail; 35 x 15 mm; 2.3 mm thick; 2 m long; unslotted; according to EN 60715; copper-colored www.wago.com/210-198



Nr. articol: 210-504
Steel carrier rail; 35 x 7.5 mm; 1 mm thick; 2 m long; slotted; galvanized; according to EN 60715 www.wago.com/210-504



Nr. articol: 210-505
Steel carrier rail; 35 x 7.5 mm; 1 mm thick; 2 m long; unslotted; galvanized; according to EN 60715 www.wago.com/210-505



Nr. articol: 210-506
Steel carrier rail; 35 x 15 mm; 1.5 mm thick; 2 m long; unslotted; galvanized; similar to EN 60715 www.wago.com/210-506



Nr. articol: 210-508
Steel carrier rail; 35 x 15 mm; 1.5 mm thick; 2 m long; slotted; galvanized; similar to EN 60715 www.wago.com/210-508

Coding

Nr. articol: 769-435
Coding pin; for coding of female plugs; for carrier terminal blocks / male connectors; orange www.wago.com/769-435

Jumper



















Nr. articol: 249-123
Push-in type wire jumper; insulated; wire length 180 mm; Conductor cross section 0.75 mm² www.wago.com/249-123

















Nr. articol: 249-125
Push-in type wire jumper; insulated; wire length 60 mm; Conductor cross section 0.75 mm² www.wago.com/249-125

















Supus modificărilor.

	Nr. articol: 249-126 Push-in type wire jumper; insulated; wire length 110 mm; Conductor cross section 0.75 mm ²	www.wago.com/249-126
	Nr. articol: 249-127 Push-in type wire jumper; insulated; wire length 250 mm; Conductor cross section 0.75 mm ²	www.wago.com/249-127
	Nr. articol: 280-402 Adjacent jumper; insulated; IN = IN terminal block; gray	www.wago.com/280-402
	Nr. articol: 280-409 Alternate jumper; insulated; IN = IN terminal block; gray	www.wago.com/280-409
	Nr. articol: 780-452 Staggered jumper; insulated; from 1 to 2; Spacing: 5 mm; suitable for 2-conductor female plugs; gray	www.wago.com/780-452
	Nr. articol: 780-453 Staggered jumper; insulated; from 1 to 3; Spacing: 5 mm; suitable for 2-conductor female plugs; gray	www.wago.com/780-453
	Nr. articol: 780-454 Staggered jumper; insulated; from 1 to 4; Spacing: 5 mm; suitable for 2-conductor female plugs; gray	www.wago.com/780-454
	Nr. articol: 780-455 Staggered jumper; insulated; from 1 to 5; Spacing: 5 mm; suitable for 2-conductor female plugs; gray	www.wago.com/780-455
	Nr. articol: 780-456 Staggered jumper; insulated; from 1 to 6; Spacing: 5 mm; suitable for 2-conductor female plugs; gray	www.wago.com/780-456
	Nr. articol: 780-457 Staggered jumper; insulated; from 1 to 7; Spacing: 5 mm; suitable for 2-conductor female plugs; gray	www.wago.com/780-457
	Nr. articol: 780-458 Staggered jumper; insulated; from 1 to 8; Spacing: 5 mm; suitable for 2-conductor female plugs; gray	www.wago.com/780-458
assembling		
	Nr. articol: 209-106 Mounting carrier; for isolated mounting on DIN 35 rails; gray	www.wago.com/209-106
General accessories		
	Nr. articol: 280-804 Empty component plug housing; 10 mm wide; Type 3; 4-pole; gray	www.wago.com/280-804
	Nr. articol: 286-110 Empty component plug housing; Type 9; 10 mm wide; 4-pole; gray	www.wago.com/286-110
	Nr. articol: 286-113 Empty component plug housing; Type 12; 25 mm wide; 10-pole; gray	www.wago.com/286-113
	Nr. articol: 286-336/001-000 Relay module; Nominal input voltage: 24 VDC; 2 break and 2 make contacts; Red status indicator; Module width: 25 mm; gray	www.wago.com/286-336/001-000
	Nr. articol: 286-344/004-000 Relay module; Nominal input voltage: 24 VDC; 3 break contacts and 1 make contact; Path; Red status indicator; Module width: 25 mm; gray	www.wago.com/286-344/004-000















Supus modificărilor.

	Nr. articol: 286-352/004-000 Relay module; Nominal input voltage: 24 VDC; 4 make contacts; Limiting continuous current: 5 A; Path; Red status indicator; Module width: 25 mm; gray	www.wago.com/286-352/004-000
	Nr. articol: 286-364 Relay module; Nominal input voltage: 24 VDC; 1 make contact; Limiting continuous current: 5 A; Red status indicator; Module width: 10 mm; gray	www.wago.com/286-364
	Nr. articol: 286-364/004-000 Relay module; Nominal input voltage: 24 VDC; 1 make contact; Path; Red status indicator; Module width: 10 mm; gray	www.wago.com/286-364/004-000
	Nr. articol: 286-368 Relay module; Nominal input voltage: 24 VDC; 1 break contact; Limiting continuous current: 5 A; Red status indicator; Module width: 10 mm; gray	www.wago.com/286-368
	Nr. articol: 286-368/004-000 Relay module; Nominal input voltage: 24 VDC; 1 break contact; Path; Red status indicator; Module width: 10 mm	www.wago.com/286-368/004-000
	Nr. articol: 286-664 Current flow monitoring module; AC currents; Monitoring range: 1 A – 10 A; 1 changeover contact; light gray	www.wago.com/286-664
	Nr. articol: 286-665 Current flow monitoring module; AC currents; Monitoring range: 1 A – 10 A; 1 changeover contact; light gray	www.wago.com/286-665
	Nr. articol: 286-742 S0 interface power supply; Input voltage: 230 VAC; S0 interface	www.wago.com/286-742
	Nr. articol: 286-791 Optocoupler module; Nominal input voltage: 24 VDC; Output voltage range: 20 ... 60 VDC; Limiting continuous current: 0.1 A; 2-wire connection; Frequency: 3 kHz; Red status indicator; Module width: 10 mm; gray	www.wago.com/286-791
	Nr. articol: 286-794 Optocoupler module; Nominal input voltage: 24 VDC; Output voltage range: 20 ... 60 VDC; Limiting continuous current: 0.1 A; 2-wire connection; Red status indicator; Module width: 10 mm; gray	www.wago.com/286-794
	Nr. articol: 286-803 Component module with diode; gray	www.wago.com/286-803
	Nr. articol: 286-809 Component module with diode; light gray	www.wago.com/286-809
	Nr. articol: 286-822 Component module with LED; Red LED; with common cathode	www.wago.com/286-822
	Nr. articol: 286-826 AND gate module with 6 inputs; light gray	www.wago.com/286-826
	Nr. articol: 286-841 Surge suppression module for signal technology; Nominal voltage: 220 VDC; for 2 signal paths with common surge arrester; pluggable on rail-mount terminal block, 25 mm wide; gray	www.wago.com/286-841
	Nr. articol: 286-842	















Supus modificărilor.

	Surge suppression module for signal technology; Nominal voltage: 230 VAC; for 2 signal paths with common surge arrester; pluggable on rail-mount terminal block, 25 mm wide; gray	www.wago.com/286-842
	Nr. articol: 286-843 Surge suppression module for signal technology; Nominal voltage: 115 VAC; for 2 signal paths with common surge arrester; pluggable on rail-mount terminal block, 25 mm wide; gray	www.wago.com/286-843
	Nr. articol: 286-844 Surge suppression module for signal technology; for 2 signal paths with common surge arrester; pluggable on rail-mount terminal block, 25 mm wide; gray	www.wago.com/286-844
	Nr. articol: 286-890 Component module with fuse; for (5 x 20) mm microfuse; Nominal voltage: 24 VAC/DC; gray	www.wago.com/286-890
	Nr. articol: 286-891 Component module with fuse; for (5 x 20) mm microfuse; Nominal voltage: 230 VAC/DC; gray	www.wago.com/286-891
	Nr. articol: 769-438 Pin cover; with marker slot for miniature WSB; gray	www.wago.com/769-438
	Nr. articol: 769-439 Pin cover; with marker slot for miniature WSB; orange	www.wago.com/769-439
	Nr. articol: 769-501 Start module for 1-conductor female connector; with integrated end plate; 4 mm ² ; 1-pole; 4,00 mm ² ; gray	www.wago.com/769-501
	Nr. articol: 769-501/000-006 Start module for 1-conductor female connector; 4 mm ² ; 1-pole; 4,00 mm ² ; blue	www.wago.com/769-501/000-006
	Nr. articol: 769-501/000-016 Start module for 1-conductor female connector; with integrated end plate; 4 mm ² ; 1-pole; 4,00 mm ² ; green-yellow	www.wago.com/769-501/000-016
	Nr. articol: 769-502 Center module for 1-conductor female connector; 4 mm ² ; 1-pole; 4,00 mm ² ; gray	www.wago.com/769-502
	Nr. articol: 769-502/000-006 Center module for 1-conductor female connector; 4 mm ² ; 1-pole; 4,00 mm ² ; blue	www.wago.com/769-502/000-006
	Nr. articol: 769-502/000-016 Center module for 1-conductor female connector; 4 mm ² ; 1-pole; 4,00 mm ² ; green-yellow	www.wago.com/769-502/000-016
	Nr. articol: 769-503 End module for 1-conductor female connector; 4 mm ² ; 1-pole; 4,00 mm ² ; gray	www.wago.com/769-503
	Nr. articol: 769-503/000-006 End module for 1-conductor female connector; 4 mm ² ; 1-pole; 4,00 mm ² ; blue	www.wago.com/769-503/000-006
	Nr. articol: 769-503/000-016 End module for 1-conductor female connector; 4 mm ² ; 1-pole; 4,00 mm ² ; green-yellow	www.wago.com/769-503/000-016

Supus modificărilor.

	Nr. articol: 769-512 Start module for 1-conductor female connector; angled; 4 mm ² ; 1-pole; 4,00 mm ² ; gray	www.wago.com/769-512
	Nr. articol: 769-512/000-006 Start module for 1-conductor female connector; angled; 4 mm ² ; 1-pole; 4,00 mm ² ; blue	www.wago.com/769-512/000-006
	Nr. articol: 769-512/000-016 Start module for 1-conductor female connector; angled; 4 mm ² ; 1-pole; 4,00 mm ² ; green-yellow	www.wago.com/769-512/000-016
	Nr. articol: 769-513 Center module for 1-conductor female connector; angled; 4 mm ² ; 1-pole; 4,00 mm ² ; gray	www.wago.com/769-513
	Nr. articol: 769-513/000-006 Center module for 1-conductor female connector; angled; 4 mm ² ; 1-pole; 4,00 mm ² ; blue	www.wago.com/769-513/000-006
	Nr. articol: 769-513/000-016 Center module for 1-conductor female connector; angled; 4 mm ² ; 1-pole; 4,00 mm ² ; green-yellow	www.wago.com/769-513/000-016
	Nr. articol: 769-515 End module for 1-conductor female connector; angled; 4 mm ² ; 1-pole; 4,00 mm ² ; gray	www.wago.com/769-515
	Nr. articol: 769-515/000-006 End module for 1-conductor female connector; angled; 4 mm ² ; 1-pole; 4,00 mm ² ; blue	www.wago.com/769-515/000-006
	Nr. articol: 769-515/000-016 End module for 1-conductor female connector; angled; 4 mm ² ; 1-pole; 4,00 mm ² ; green-yellow	www.wago.com/769-515/000-016
	Nr. articol: 786-103 Empty component plug housing; Type 16; 25 mm wide; 10-pole; gray	www.wago.com/786-103
Female plug		
	Nr. articol: 769-101 1-conductor female plug; 4 mm ² ; 1-pole; 4,00 mm ² ; gray	www.wago.com/769-101
	Nr. articol: 769-101/000-006 1-conductor female plug; 4 mm ² ; 1-pole; 4,00 mm ² ; blue	www.wago.com/769-101/000-006
	Nr. articol: 769-101/000-016 1-conductor female plug; 4 mm ² ; 1-pole; 4,00 mm ² ; green-yellow	www.wago.com/769-101/000-016
	Nr. articol: 769-101/022-000 1-conductor female plug; angled; 4 mm ² ; 1-pole; 4,00 mm ² ; gray	www.wago.com/769-101/022-000

Supus modificărilor.

	Nr. articol: 769-101/022-016 1-conductor female plug; angled; 4 mm ² ; 1-pole; 4,00 mm ² ; green-yellow	www.wago.com/769-101/022-016
	Nr. articol: 769-102 1-conductor female plug; 4 mm ² ; 2-pole; 4,00 mm ² ; gray	www.wago.com/769-102
	Nr. articol: 769-102/000-006 1-conductor female plug; 4 mm ² ; 2-pole; 4,00 mm ² ; blue	www.wago.com/769-102/000-006
	Nr. articol: 769-102/000-036 1-conductor female plug; 4 mm ² ; 2-pole; 4,00 mm ² ; gray, green-yellow	www.wago.com/769-102/000-036
	Nr. articol: 769-102/000-037 1-conductor female plug; 4 mm ² ; 2-pole; 4,00 mm ² ; green-yellow, gray	www.wago.com/769-102/000-037
	Nr. articol: 769-102/022-000 1-conductor female plug; angled; 4 mm ² ; 2-pole; 4,00 mm ² ; gray	www.wago.com/769-102/022-000
	Nr. articol: 769-103 1-conductor female plug; 4 mm ² ; 3-pole; 4,00 mm ² ; gray	www.wago.com/769-103
	Nr. articol: 769-103/000-006 1-conductor female plug; 4 mm ² ; 3-pole; 4,00 mm ² ; blue	www.wago.com/769-103/000-006
	Nr. articol: 769-103/000-036 1-conductor female plug; 4 mm ² ; 3-pole; 4,00 mm ² ; gray, green-yellow	www.wago.com/769-103/000-036
	Nr. articol: 769-103/000-037 1-conductor female plug; 4 mm ² ; 3-pole; 4,00 mm ² ; green-yellow, gray	www.wago.com/769-103/000-037
	Nr. articol: 769-103/000-038 1-conductor female plug; 4 mm ² ; 3-pole; 4,00 mm ² ; gray, blue, green-yellow	www.wago.com/769-103/000-038
	Nr. articol: 769-103/000-039 1-conductor female plug; 4 mm ² ; 3-pole; 4,00 mm ² ; green-yellow, blue, gray	www.wago.com/769-103/000-039
	Nr. articol: 769-103/022-000 1-conductor female plug; angled; 4 mm ² ; 3-pole; 4,00 mm ² ; gray	www.wago.com/769-103/022-000
	Nr. articol: 769-104 1-conductor female plug; 4 mm ² ; 4-pole; 4,00 mm ² ; gray	www.wago.com/769-104

Supus modificărilor.



Nr. articol: 769-104/000-006

1-conductor female plug; 4 mm²; 4-pole; 4,00 mm²; blue

www.wago.com/769-104/000-006



Nr. articol: 769-104/000-036

1-conductor female plug; 4 mm²; 4-pole; 4,00 mm²; gray, green-yellow

www.wago.com/769-104/000-036



Nr. articol: 769-104/000-037

1-conductor female plug; 4 mm²; 4-pole; 4,00 mm²; green-yellow, gray

www.wago.com/769-104/000-037



Nr. articol: 769-104/000-038

1-conductor female plug; 4 mm²; 4-pole; 4,00 mm²; gray, blue, green-yellow

www.wago.com/769-104/000-038



Nr. articol: 769-104/000-039

1-conductor female plug; 4 mm²; 4-pole; 4,00 mm²; green-yellow, blue, gray

www.wago.com/769-104/000-039



Nr. articol: 769-104/022-000

1-conductor female plug; angled; 4 mm²; 4-pole; 4,00 mm²; gray

www.wago.com/769-104/022-000



Nr. articol: 769-105

1-conductor female plug; 4 mm²; 5-pole; 4,00 mm²; gray

www.wago.com/769-105



Nr. articol: 769-105/000-006

1-conductor female plug; 4 mm²; 5-pole; 4,00 mm²; blue

www.wago.com/769-105/000-006



Nr. articol: 769-105/000-036

1-conductor female plug; 4 mm²; 5-pole; 4,00 mm²; gray, green-yellow

www.wago.com/769-105/000-036



Nr. articol: 769-105/000-037

1-conductor female plug; 4 mm²; 5-pole; 4,00 mm²; green-yellow, gray

www.wago.com/769-105/000-037



Nr. articol: 769-105/000-038

1-conductor female plug; 4 mm²; 5-pole; 4,00 mm²; gray, blue, green-yellow

www.wago.com/769-105/000-038



Nr. articol: 769-105/000-039

1-conductor female plug; 4 mm²; 5-pole; 4,00 mm²; green-yellow, blue, gray

www.wago.com/769-105/000-039



Nr. articol: 769-105/022-000

1-conductor female plug; angled; 4 mm²; 5-pole; 4,00 mm²; gray

www.wago.com/769-105/022-000

















Nr. articol: 769-106















1-conductor female plug; 4 mm²; 6-pole; 4,00 mm²; gray

www.wago.com/769-106















Supus modificărilor.

	Nr. articol: 769-106/000-006 1-conductor female plug; 4 mm ² ; 6-pole; 4,00 mm ² ; blue	www.wago.com/769-106/000-006
	Nr. articol: 769-106/000-036 1-conductor female plug; 4 mm ² ; 6-pole; 4,00 mm ² ; gray, green-yellow	www.wago.com/769-106/000-036
	Nr. articol: 769-106/000-037 1-conductor female plug; 4 mm ² ; 6-pole; 4,00 mm ² ; green-yellow, gray	www.wago.com/769-106/000-037
	Nr. articol: 769-106/000-038 1-conductor female plug; 4 mm ² ; 6-pole; 4,00 mm ² ; gray, blue, green-yellow	www.wago.com/769-106/000-038
	Nr. articol: 769-106/000-039 1-conductor female plug; 4 mm ² ; 6-pole; 4,00 mm ² ; green-yellow, blue, gray	www.wago.com/769-106/000-039
	Nr. articol: 769-106/022-000 1-conductor female plug; angled; 4 mm ² ; 6-pole; 4,00 mm ² ; gray	www.wago.com/769-106/022-000
	Nr. articol: 769-107 1-conductor female plug; 4 mm ² ; 7-pole; 4,00 mm ² ; gray	www.wago.com/769-107
	Nr. articol: 769-107/000-006 1-conductor female plug; 4 mm ² ; 7-pole; 4,00 mm ² ; blue	www.wago.com/769-107/000-006
	Nr. articol: 769-107/000-036 1-conductor female plug; 4 mm ² ; 7-pole; 4,00 mm ² ; gray, green-yellow	www.wago.com/769-107/000-036
	Nr. articol: 769-107/000-037 1-conductor female plug; 4 mm ² ; 7-pole; 4,00 mm ² ; green-yellow, gray	www.wago.com/769-107/000-037
	Nr. articol: 769-107/000-038 1-conductor female plug; 4 mm ² ; 7-pole; 4,00 mm ² ; gray, blue, green-yellow	www.wago.com/769-107/000-038
	Nr. articol: 769-107/000-039 1-conductor female plug; 4 mm ² ; 7-pole; 4,00 mm ² ; green-yellow, blue, gray	www.wago.com/769-107/000-039
	Nr. articol: 769-107/022-000 1-conductor female plug; angled; 4 mm ² ; 7-pole; 4,00 mm ² ; gray	www.wago.com/769-107/022-000
	Nr. articol: 769-108 1-conductor female plug; 4 mm ² ; 8-pole; 4,00 mm ² ; gray	www.wago.com/769-108

Supus modificărilor.

	Nr. articol: 769-108/000-006 1-conductor female plug; 4 mm ² ; 8-pole; 4,00 mm ² ; blue	www.wago.com/769-108/000-006
	Nr. articol: 769-108/000-036 1-conductor female plug; 4 mm ² ; 8-pole; 4,00 mm ² ; gray, green-yellow	www.wago.com/769-108/000-036
	Nr. articol: 769-108/000-037 1-conductor female plug; 4 mm ² ; 8-pole; 4,00 mm ² ; green-yellow, gray	www.wago.com/769-108/000-037
	Nr. articol: 769-108/000-038 1-conductor female plug; 4 mm ² ; 8-pole; 4,00 mm ² ; gray, blue, green-yellow	www.wago.com/769-108/000-038
	Nr. articol: 769-108/000-039 1-conductor female plug; 4 mm ² ; 8-pole; 4,00 mm ² ; green-yellow, blue, gray	www.wago.com/769-108/000-039
	Nr. articol: 769-108/022-000 1-conductor female plug; angled; 4 mm ² ; 8-pole; 4,00 mm ² ; gray	www.wago.com/769-108/022-000
	Nr. articol: 769-109 1-conductor female plug; 4 mm ² ; 9-pole; 4,00 mm ² ; gray	www.wago.com/769-109
	Nr. articol: 769-109/000-006 1-conductor female plug; 4 mm ² ; 9-pole; 4,00 mm ² ; blue	www.wago.com/769-109/000-006
	Nr. articol: 769-109/000-036 1-conductor female plug; 4 mm ² ; 9-pole; 4,00 mm ² ; gray, green-yellow	www.wago.com/769-109/000-036
	Nr. articol: 769-109/000-037 1-conductor female plug; 4 mm ² ; 9-pole; 4,00 mm ² ; green-yellow, gray	www.wago.com/769-109/000-037
	Nr. articol: 769-109/000-038 1-conductor female plug; 4 mm ² ; 9-pole; 4,00 mm ² ; gray, blue, green-yellow	www.wago.com/769-109/000-038
	Nr. articol: 769-109/000-039 1-conductor female plug; 4 mm ² ; 9-pole; 4,00 mm ² ; green-yellow, blue, gray	www.wago.com/769-109/000-039
	Nr. articol: 769-109/022-000 1-conductor female plug; angled; 4 mm ² ; 9-pole; 4,00 mm ² ; gray	www.wago.com/769-109/022-000
	Nr. articol: 769-110 1-conductor female plug; 4 mm ² ; 10-pole; 4,00 mm ² ; gray	www.wago.com/769-110

Supus modificărilor.

	<p>Nr. articol: 769-110/000-006 1-conductor female plug; 4 mm²; 10-pole; 4,00 mm²; blue</p>	www.wago.com/769-110/000-006
	<p>Nr. articol: 769-110/000-036 1-conductor female plug; 4 mm²; 10-pole; 4,00 mm²; gray, green-yellow</p>	www.wago.com/769-110/000-036
	<p>Nr. articol: 769-110/000-037 1-conductor female plug; 4 mm²; 10-pole; 4,00 mm²; green-yellow, gray</p>	www.wago.com/769-110/000-037
	<p>Nr. articol: 769-110/000-038 1-conductor female plug; 4 mm²; 10-pole; 4,00 mm²; gray, blue, green-yellow</p>	www.wago.com/769-110/000-038
	<p>Nr. articol: 769-110/000-039 1-conductor female plug; 4 mm²; 10-pole; 4,00 mm²; green-yellow, blue, gray</p>	www.wago.com/769-110/000-039
	<p>Nr. articol: 769-110/022-000 1-conductor female plug; angled; 4 mm²; 10-pole; 4,00 mm²; gray</p>	www.wago.com/769-110/022-000
	<p>Nr. articol: 769-111 1-conductor female plug; 4 mm²; 11-pole; 4,00 mm²; gray</p>	www.wago.com/769-111
	<p>Nr. articol: 769-111/000-006 1-conductor female plug; 4 mm²; 11-pole; 4,00 mm²; blue</p>	www.wago.com/769-111/000-006
	<p>Nr. articol: 769-111/000-036 1-conductor female plug; 4 mm²; 11-pole; 4,00 mm²; gray, green-yellow</p>	www.wago.com/769-111/000-036
	<p>Nr. articol: 769-111/000-037 1-conductor female plug; 4 mm²; 11-pole; 4,00 mm²; green-yellow, gray</p>	www.wago.com/769-111/000-037
	<p>Nr. articol: 769-111/000-038 1-conductor female plug; 4 mm²; 11-pole; 4,00 mm²; gray, blue, green-yellow</p>	www.wago.com/769-111/000-038
	<p>Nr. articol: 769-111/000-039 1-conductor female plug; 4 mm²; 11-pole; 4,00 mm²; green-yellow, blue, gray</p>	www.wago.com/769-111/000-039
	<p>Nr. articol: 769-111/022-000 1-conductor female plug; angled; 4 mm²; 11-pole; 4,00 mm²; gray</p>	www.wago.com/769-111/022-000
	<p>Nr. articol: 769-112 1-conductor female plug; 4 mm²; 12-pole; 4,00 mm²; gray</p>	www.wago.com/769-112

Supus modificărilor.



Nr. articol: 769-112/000-006

1-conductor female plug; 4 mm²; 12-pole; 4,00 mm²; blue

www.wago.com/769-112/000-006



Nr. articol: 769-112/000-036

1-conductor female plug; 4 mm²; 12-pole; 4,00 mm²; gray, green-yellow

www.wago.com/769-112/000-036



Nr. articol: 769-112/000-037

1-conductor female plug; 4 mm²; 12-pole; 4,00 mm²; green-yellow, gray

www.wago.com/769-112/000-037



Nr. articol: 769-112/000-038

1-conductor female plug; 4 mm²; 12-pole; 4,00 mm²; gray, blue, green-yellow

www.wago.com/769-112/000-038



Nr. articol: 769-112/000-039

1-conductor female plug; 4 mm²; 12-pole; 4,00 mm²; green-yellow, blue, gray

www.wago.com/769-112/000-039



Nr. articol: 769-112/022-000

1-conductor female plug; angled; 4 mm²; 12-pole; 4,00 mm²; gray

www.wago.com/769-112/022-000



Nr. articol: 769-113

1-conductor female plug; 4 mm²; 13-pole; 4,00 mm²; gray

www.wago.com/769-113



Nr. articol: 769-113/000-036

1-conductor female plug; 4 mm²; 13-pole; 4,00 mm²; gray, green-yellow

www.wago.com/769-113/000-036



Nr. articol: 769-113/000-037

1-conductor female plug; 4 mm²; 13-pole; 4,00 mm²; green-yellow, gray

www.wago.com/769-113/000-037



Nr. articol: 769-113/000-038

1-conductor female plug; 4 mm²; 13-pole; 4,00 mm²; gray, blue, green-yellow

www.wago.com/769-113/000-038



Nr. articol: 769-113/000-039

1-conductor female plug; 4 mm²; 13-pole; 4,00 mm²; green-yellow, blue, gray

www.wago.com/769-113/000-039



Nr. articol: 769-113/022-000

1-conductor female plug; angled; 4 mm²; 13-pole; 4,00 mm²; gray

www.wago.com/769-113/022-000



Nr. articol: 769-114

1-conductor female plug; 4 mm²; 14-pole; 4,00 mm²; gray

www.wago.com/769-114

















Nr. articol: 769-114/000-006















1-conductor female plug; 4 mm²; 14-pole; 4,00 mm²; blue

www.wago.com/769-114/000-006

Supus modificărilor.

	Nr. articol: 769-114/000-036 1-conductor female plug; 4 mm ² ; 14-pole; 4,00 mm ² ; gray, green-yellow	www.wago.com/769-114/000-036
	Nr. articol: 769-114/000-037 1-conductor female plug; 4 mm ² ; 14-pole; 4,00 mm ² ; green-yellow, gray	www.wago.com/769-114/000-037
	Nr. articol: 769-114/000-038 1-conductor female plug; 4 mm ² ; 14-pole; 4,00 mm ² ; gray, blue, green-yellow	www.wago.com/769-114/000-038
	Nr. articol: 769-114/000-039 1-conductor female plug; 4 mm ² ; 14-pole; 4,00 mm ² ; green-yellow, blue, gray	www.wago.com/769-114/000-039
	Nr. articol: 769-114/022-000 1-conductor female plug; angled; 4 mm ² ; 14-pole; 4,00 mm ² ; gray	www.wago.com/769-114/022-000
	Nr. articol: 769-115 1-conductor female plug; 4 mm ² ; 15-pole; 4,00 mm ² ; gray	www.wago.com/769-115
	Nr. articol: 769-115/000-036 1-conductor female plug; 4 mm ² ; 15-pole; 4,00 mm ² ; gray, green-yellow	www.wago.com/769-115/000-036
	Nr. articol: 769-115/000-037 1-conductor female plug; 4 mm ² ; 15-pole; 4,00 mm ² ; green-yellow, gray	www.wago.com/769-115/000-037
	Nr. articol: 769-115/000-038 1-conductor female plug; 4 mm ² ; 15-pole; 4,00 mm ² ; gray, blue, green-yellow	www.wago.com/769-115/000-038
	Nr. articol: 769-115/000-039 1-conductor female plug; 4 mm ² ; 15-pole; 4,00 mm ² ; green-yellow, blue, gray	www.wago.com/769-115/000-039
	Nr. articol: 769-115/022-000 1-conductor female plug; angled; 4 mm ² ; 15-pole; 4,00 mm ² ; gray	www.wago.com/769-115/022-000
check		
	Nr. articol: 210-137 Test plug; 2.3 mm Ø; with 500 mm cable; yellow	www.wago.com/210-137
	Nr. articol: 280-404 Test plug adapter; 5 mm wide; for test plug 210-137 (2.3 mm Ø); suitable for 1.5 mm ² - 4 mm ² tbs; gray	www.wago.com/280-404
	Nr. articol: 280-418 Test plug module; modular; suitable for all WAGO 280 and 780 Series rail-mounted terminal blocks with jumper slots in the current bar; gray	www.wago.com/280-418

Supus modificărilor.

	Nr. articol: 280-419 Spacer module; modular; bridging commoned terminal blocks; gray	www.wago.com/280-419
End plate		
	Nr. articol: 769-309 End and intermediate plate; 1.1 mm thick; gray	www.wago.com/769-309
	Nr. articol: 769-310 End and intermediate plate; 1.1 mm thick; orange	www.wago.com/769-310
	Nr. articol: 769-313 Separator plate; 1.1 mm thick; oversized; orange	www.wago.com/769-313
Marking accessories		
	Nr. articol: 2009-145 Mini-WSB Inline; for Smart Printer; 1700 pieces on roll; stretchable 5 - 5.2 mm; plain; snap-on type; white	www.wago.com/2009-145
	Nr. articol: 2009-145/000-002 Mini-WSB Inline; for Smart Printer; 1700 pieces on roll; stretchable 5 - 5.2 mm; plain; snap-on type; yellow	www.wago.com/2009-145/000-002
	Nr. articol: 2009-145/000-005 Mini-WSB Inline; for Smart Printer; 1700 pieces on roll; stretchable 5 - 5.2 mm; plain; snap-on type; red	www.wago.com/2009-145/000-005
	Nr. articol: 2009-145/000-006 Mini-WSB Inline; for Smart Printer; 1700 pieces on roll; stretchable 5 - 5.2 mm; plain; snap-on type; blue	www.wago.com/2009-145/000-006
	Nr. articol: 2009-145/000-007 Mini-WSB Inline; for Smart Printer; 1700 pieces on roll; stretchable 5 - 5.2 mm; plain; snap-on type; gray	www.wago.com/2009-145/000-007
	Nr. articol: 2009-145/000-012 Mini-WSB Inline; for Smart Printer; 1700 pieces on roll; stretchable 5 - 5.2 mm; plain; snap-on type; orange	www.wago.com/2009-145/000-012
	Nr. articol: 2009-145/000-023 Mini-WSB Inline; for Smart Printer; 1700 pieces on roll; stretchable 5 - 5.2 mm; plain; snap-on type; green	www.wago.com/2009-145/000-023
	Nr. articol: 2009-145/000-024 Mini-WSB Inline; for Smart Printer; 1700 pieces on roll; stretchable 5 - 5.2 mm; plain; snap-on type; violet	www.wago.com/2009-145/000-024
	Nr. articol: 248-501 Miniature WSB Quick marking system; plain; Marker width 5 mm; 10 strips with 10 markers per card	www.wago.com/248-501
	Nr. articol: 248-501/000-002 Mini-WSB marking card; as card; not stretchable; plain; snap-on type; yellow	www.wago.com/248-501/000-002

Supus modificărilor.

WAGO Kontakttechnik GmbH & Co. KG
/Representative Office Romania
Sos. Pipera-Tunari nr. 1/1
building 1, 2nd floor | 077190 Voluntari, Ilfov
Tel.: +40-(0)31 421 85 68 | Email: info-RO@wago.com

Aveți întrebări despre produsele noastre?
Vă stăm la dispoziție pentru preluarea apelului la +40 (0) 31 421 85 68.



Nr. articol: 248-501/000-005
Mini-WSB marking card; as card; not stretchable; plain; snap-on type; red

www.wago.com/248-501/000-005



Nr. articol: 248-501/000-006
Mini-WSB marking card; as card; not stretchable; plain; snap-on type; blue

www.wago.com/248-501/000-006



Nr. articol: 248-501/000-007
Mini-WSB marking card; as card; not stretchable; plain; snap-on type; gray

www.wago.com/248-501/000-007



Nr. articol: 248-501/000-012
Mini-WSB marking card; as card; not stretchable; plain; snap-on type; orange

www.wago.com/248-501/000-012



Nr. articol: 248-501/000-017
Mini-WSB marking card; as card; not stretchable; plain; snap-on type; light green

www.wago.com/248-501/000-017



Nr. articol: 248-501/000-023
Mini-WSB marking card; as card; not stretchable; plain; snap-on type; green

www.wago.com/248-501/000-023



Nr. articol: 248-501/000-024
Mini-WSB marking card; as card; not stretchable; plain; snap-on type; violet

www.wago.com/248-501/000-024

Descărcări Documentation

Additional Information

Technical explanations	Apr 3, 2019	pdf 2,1 MB	Descărcare
------------------------	-------------	---------------	------------

CAD/CAE-Data

CAD data

2D/3D Models 769-162/769-313	URL	Descărcare
------------------------------	-----	------------

CAE data

EPLAN Data Portal 769-162/769-313	URL	Descărcare
-----------------------------------	-----	------------

WSCAD Universe 769-162/769-313	URL	Descărcare
--------------------------------	-----	------------

Supus modificărilor.

WAGO Kontakttechnik GmbH & Co. KG
/Representative Office Romania
Sos. Pipera-Tunari nr. 1/1
building 1, 2nd floor | 077190 Voluntari, Ilfov
Tel.: +40-(0)31 421 85 68 | Email: info-RO@wago.com

Aveți întrebări despre produsele noastre?
Vă stăm la dispoziție pentru preluarea apelului la +40 (0) 31 421 85 68.

Installation Notes

Installation

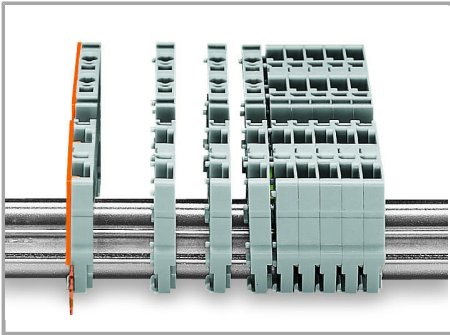

Snap individual carrier terminal blocks onto the carrier rail and slide together.

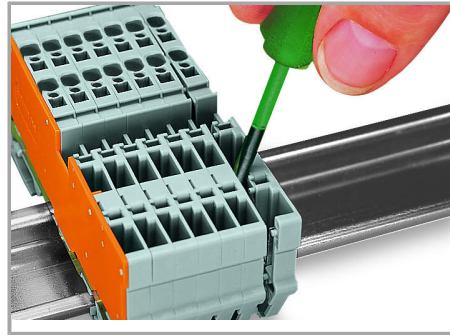

Open the assembly by laterally sliding a block via operating tool and remove terminal block via release lever.

Commoning

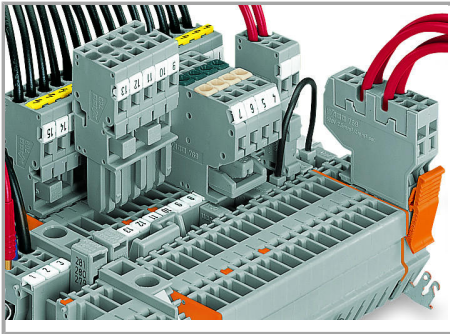

Commoning with adjacent or staggered jumpers –

push jumpers down until fully inserted.

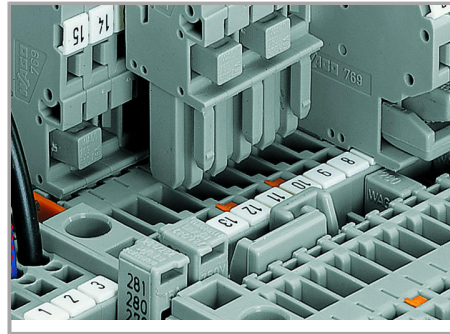

Commoning carrier terminal blocks via staggered jumpers.

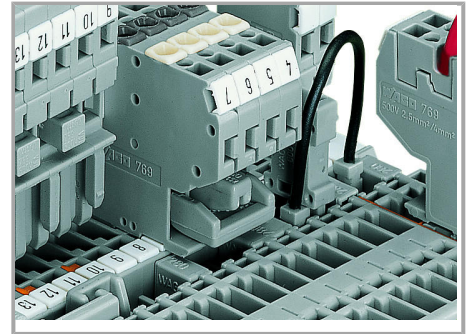

Commoning a 2-conductor female plug via staggered jumper and carrier terminal blocks via adjacent jumpers.

Supus modificărilor.

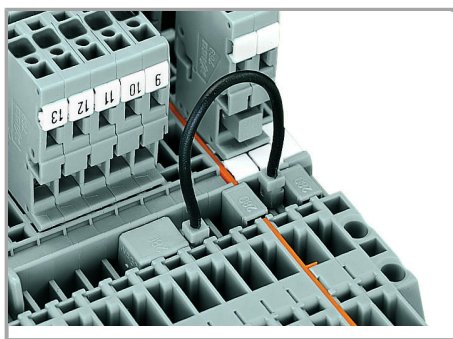

Commoning carrier terminal blocks via push-in type wire jumpers or adjacent jumpers – even over an intermediate plate.

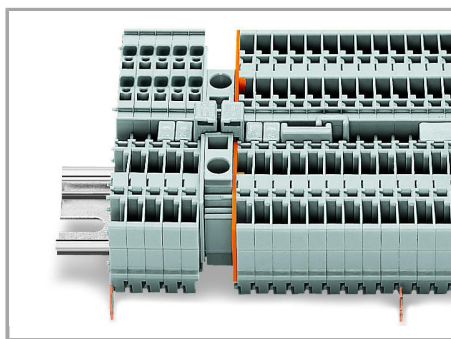

Commoning “supply terminal blocks” (up to 10 mm²/8 AWG) with carrier terminal blocks via step-down jumpers.

Testing

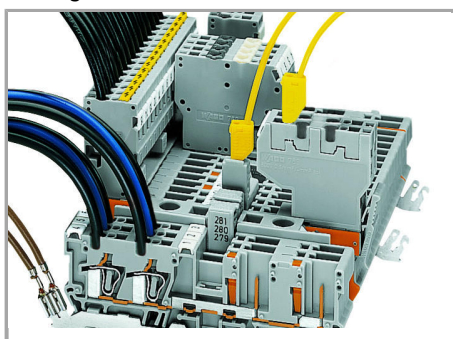

Testing via 2 or 2.3 mm Ø test plugs.

Coding

Supus modificărilor.

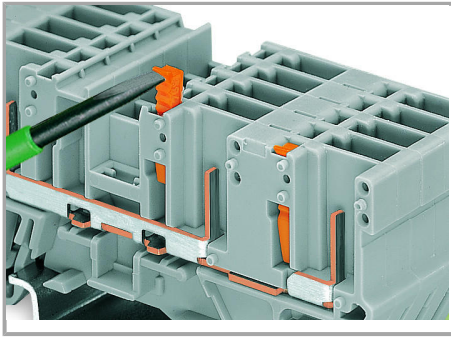

Snap coding pin in proper direction on carrier terminal block.

Shown: Coding pin removal from carrier terminal block.

Locking lever

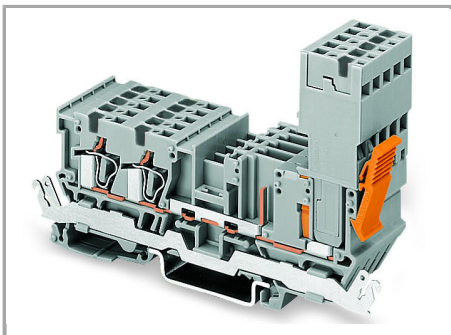

Female plug secured with locking lever on the terminal block side.

Supus modificărilor.

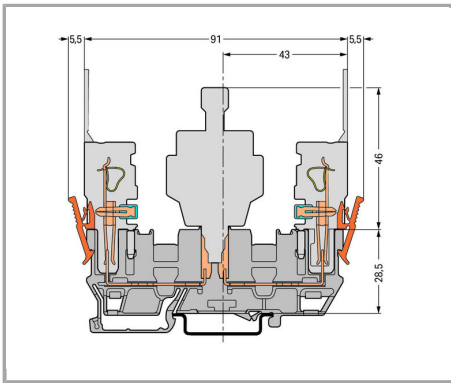

Carrier terminal block

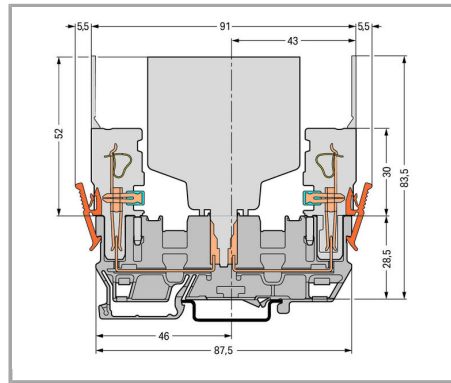

Carrier terminal block

For other dimensions, see 769-151 Carrier Terminal Block.

Familie de produse

X-COM

Afișare globală produse din familie.

Supus modificărilor.